

TVS/Zener

Device Data



MOTOROLA

Index of Part Numbers	1
Cross Reference Guide	2
Preferred Part Numbers Guide	3
Selector Guides and Data Sheets	4
Packaging Information	5
Technical Information	6
Application Notes and Articles	7

Surmetic and MOSORB are trademarks of Motorola, Inc.



MOTOROLA

TRANSIENT VOLTAGE SUPPRESSORS AND ZENER DIODES

Prepared by
Technical Information Center

This book presents technical data for the broad line of Motorola Transient Voltage Suppressors and Zener Diodes. Complete specifications for the individual devices are provided in the form of data sheets. A comprehensive Selector Guide and Industry Cross-Reference Guide are included to simplify the task of choosing the best set of components required for a specific application. A preferred parts list is also provided to assist in the selection process.

Finally, to assist the circuit designer the popular Motorola Zener Diode Handbook and related application notes and technical articles have been added to make this a more complete reference book.

Motorola reserves the right to make changes without further notice to any products herein to improve reliability, function or design. Motorola does not assume any liability arising out of the application or use of any product or circuit described herein; neither does it convey any license under its patent rights nor the rights of others. Motorola products are not designed, intended, or authorized for use as components in systems intended for surgical implant into the body, or other applications intended to support or sustain life, or for any other application in which the failure of the Motorola product could create a situation where personal injury or death may occur. Should Buyer purchase or use Motorola products for any such unintended or unauthorized application, Buyer shall indemnify and hold Motorola and its officers, employees, subsidiaries, affiliates, and distributors harmless against all claims, costs, damages, and expenses, and reasonable attorney fees arising out of, directly or indirectly, any claim of personal injury or death associated with such unintended or unauthorized use, even if such claim alleges that Motorola was negligent regarding the design or manufacture of the part. Motorola and  are registered trademarks of Motorola, Inc. Motorola, Inc. is an Equal Opportunity/Affirmative Action Employer.

© Motorola Inc., 1991
First Edition
First Printing
"All Rights Reserved"

INTRODUCTION

Motorola is the number 1 supplier of Zener Diodes and Zener Transient Voltage Suppressors in the world market. Our product performance and Six Sigma quality and service initiatives have enabled us to be the Zener Diode supplier of choice around the world.

The Motorola Zener product portfolio includes Zener regulators, temperature compensated devices, and transient voltage suppressors. Nearly all of these devices are offered in both the conventional through hole construction packages and the newer surface mount packages.

Our emphasis on continuous improvement and total customer satisfaction applies to everything we do. This data book is a good example of this continuous improvement process. For the first time the Motorola Zener Data Book includes theory and applications information in addition to the actual product specific data. The actual layout has been revised to be more user friendly with Sections on the three major categories of Zener Diodes — Regulation, Temperature Compensation, and Transient Voltage Protection.

This never ending improvement process relies on you, the customer, for future changes to our products and processes. We look forward to the opportunity to satisfy all of your Zener Diode needs.

Gary Beaudin
Manager, Zener Diodes

This section is the master index of all the basic part numbers specified on the Data Sheets in Section 4. For your convenience this Index is presented in two different formats.

The first listing is organized by category, i.e., application, type of package mounting, power wattage level, and part number series within each subcategory. This list is in the same sequence as that of Data Sheet Section 4.

The second listing is by individual part number in alphanumeric sequence. For brevity many of the available suffixes are omitted and only the prime 5% tolerance and in some cases the 10% tolerance suffixes are listed. Consult the Data Sheet section which specifies the prime part number to determine the status of other suffixes.

INDEX OF PART NUMBERS BY CATEGORY

Section 4.1 – Transient Voltage Suppressors

4.1.4.1 Transient Voltage Suppressors Axial Leaded

4.1.4.1.1 Transient Voltage Suppressors Axial Leaded 500 Watt Peak Power

SA5.0 thru SA170A 4-1-25

4.1.4.1.2 Transient Voltage Suppressors Axial Leaded 600 Watt Peak Power

P6KE6.8, A thru P6KE200, A 4-1-32

4.1.4.1.3 Transient Voltage Suppressors Axial Leaded 1500 Watt Peak Power

1. General Data 4-1-38

2. 1N5908 4-1-42

3. 1N6267 thru 1N6303A, 1.5KE6.8 thru 1.5KE250A 4-1-43

4. 1N6373 thru 1N6389, ICTE-5 thru ICTE-45C, MPTE-5 thru MPTE-45C 4-1-46

4.1.4.1.4 Transient Voltage Suppressors Axial Leaded Automotive 110 Amp Peak

MR2535L 4-1-48

4.1.4.2.1 Transient Voltage Suppressors Surface Mounted 40 Watt Peak Power SOT-23

MMBZ15VDLT1 4-1-52

4.1.4.2.2 Transient Voltage Suppressors Surface Mounted 600 Watt Peak Power SMB

1. General Data 4-1-56

2. 1SMB5.0AT3 thru 1SMB170AT3 4-1-59

3. P6SMB6.8AT3 thru P6SMB200AT3 4-1-60

4.1.4.2.3 Transient Voltage Suppressors Surface Mounted 1500 Watt Peak Power SMC

1. General Data 4-1-62

2. 1SMC5.0AT3 thru 1SMC78AT3 4-1-65

3. 1.5SMC6.8AT3 thru 1.5SMC91AT3 4-1-66

Section 4.2 – Zener Voltage Regulator Diodes

4.2.4.1 Zener Voltage Regulator Diodes Axial Leaded

4.2.4.1.1 Zener Voltage Regulator Diodes Axial Leaded 500 mWatt DO-35 Glass

1. General Data 4-2-22

2. 1N746A thru 1N759A, 1N957B thru 1N992B, 1N4370A thru 1N4372A 4-2-28

3. 1N4678 thru 1N4717 4-2-30

4. 1N5221B thru 1N5281B 4-2-31

5. 1N5985B thru 1N6025B 4-2-33

6. BZX55C2V4 thru BZX55C91 4-2-34

7. BZX79C2V4 thru BZX79C200 4-2-35

8. BZX83C2V7 thru BZX83C33, M-ZPD2.7 thru M-ZPD33 4-2-36

9. MZ4099 thru MZ4104, MZ4614 thru MZ4627 4-2-37

10. MZ5520B thru MZ5530B 4-2-38

INDEX OF PART NUMBERS BY CATEGORY (continued)
Section 4.2 – Zener Voltage Regulator Diodes (continued)

4.2.4.1.2 Zener Voltage Regulator Diodes Axial Leaded 1-1.3 Watt DO-41 Glass

1. General Data	4-2-40
2. 1N4728A thru 1N4764A	4-2-44
3. BZX85C3V3 thru BZX85C100	4-2-45
4. M-ZPY3.9 thru M-ZPY100	4-2-46

4.2.4.1.3 Zener Voltage Regulator Diodes Axial Leaded 1-3 Watt DO-41 Surmetic 30

1. General Data	4-2-48
2. 1N5913B thru 1N5956B	4-2-51
3. 3EZ3.9D5 thru 3EZ400D5	4-2-53
4. MZD3.9 thru MZD200	4-2-55
5. MZP4728A thru MZP4764A, 1M110ZS5 thru 1M200ZS5	4-2-56

4.2.4.1.4 Zener Voltage Regulator Diodes Axial Leaded 5 Watt Surmetic 40

1N5333B thru 1N5388B	4-2-58
----------------------------	--------

4.2.4.2 Zener Voltage Regulator Diodes Surface Mounted

4.2.4.2.1 Zener Voltage Regulator Diodes Surface Mounted 225 mW SOT-23

1. General Data	4-2-64
2. BZX84C2V4L thru BZX84C75L	4-2-65
3. MMBZ5221BL thru MMBZ5270BL	4-2-66

4.2.4.2.2 Zener Voltage Regulator Diodes Surface Mounted 500 mWatt Leadless DO-34

1. General Data	4-2-68
2. BZV55C2V4 thru BZV55C56	4-2-73
3. MLL4678 thru MLL4717	4-2-74
4. MLL5221B thru MLL5263B	4-2-75

4.2.4.2.3 Zener Voltage Regulator Diodes Surface Mounted 1.5 Watt DC Power SMB

1SMB5913BT3 thru 1SMB5956BT3	4-2-78
------------------------------------	--------

Section 4.3 – Zener Voltage Reference Diodes

4.3.4 Zener Voltage Reference Diodes

4.3.4.1.1 Zener Voltage Reference Diodes Axial Leaded 6.2 V OTC 400 mW DO-35

1N821 thru 1N829A	4-3-10
-------------------------	--------

4.3.4.1.2 Zener Voltage Reference Diodes Axial Leaded 6.4 V OTC 400 mW DO-35

1N4565 thru 1N4574A	4-3-14
---------------------------	--------



ALPHANUMERIC INDEX

DEVICE	PAGE	DEVICE	PAGE	DEVICE	PAGE
1M110ZS5	4-2-56	1N967B	4-2-28	1N4571	4-3-15
1M120ZS5	4-2-56	1N968B	4-2-28	1N4571A	4-3-15
1M130ZS5	4-2-56	1N969B	4-2-28	1N4572	4-3-15
1M150ZS5	4-2-56	1N970B	4-2-28	1N4572A	4-3-15
1M160ZS5	4-2-56	1N971B	4-2-28	1N4573	4-3-15
1M180ZS5	4-2-56	1N972B	4-2-28	1N4573A	4-3-15
1M200ZS5	4-2-56	1N973B	4-2-28	1N4574	4-3-15
1N746A	4-2-28	1N974B	4-2-28	1N4574A	4-3-15
1N747A	4-2-28	1N975B	4-2-28	1N4678	4-2-30
1N748A	4-2-28	1N976B	4-2-28	1N4679	4-2-30
1N749A	4-2-28	1N977B	4-2-28	1N4680	4-2-30
1N750A	4-2-28	1N978B	4-2-28	1N4681	4-2-30
1N751A	4-2-28	1N979B	4-2-28	1N4682	4-2-30
1N752A	4-2-28	1N980B	4-2-28	1N4683	4-2-30
1N753A	4-2-28	1N981B	4-2-29	1N4684	4-2-30
1N754A	4-2-28	1N982B	4-2-29	1N4685	4-2-30
1N755A	4-2-28	1N983B	4-2-29	1N4686	4-2-30
1N756A	4-2-28	1N984B	4-2-29	1N4687	4-2-30
1N757A	4-2-28	1N985B	4-2-29	1N4688	4-2-30
1N758A	4-2-28	1N986B	4-2-29	1N4689	4-2-30
1N759A	4-2-28	1N987B	4-2-29	1N4690	4-2-30
1N821	4-3-10	1N988B	4-2-29	1N4691	4-2-30
1N821A	4-3-10	1N989B	4-2-29	1N4692	4-2-30
1N823	4-3-10	1N990B	4-2-29	1N4693	4-2-30
1N823A	4-3-10	1N991B	4-2-29	1N4694	4-2-30
1N825	4-3-10	1N992B	4-2-29	1N4695	4-2-30
1N825A	4-3-10	1N4370A	4-2-28	1N4696	4-2-30
1N827	4-3-10	1N4371A	4-2-28	1N4697	4-2-30
1N827A	4-3-10	1N4372A	4-2-28	1N4698	4-2-30
1N829	4-3-10	1N4565	4-3-15	1N4699	4-2-30
1N829A	4-3-10	1N4565A	4-3-15	1N4700	4-2-30
1N957B	4-2-28	1N4566	4-3-15	1N4701	4-2-30
1N958B	4-2-28	1N4566A	4-3-15	1N4702	4-2-30
1N959B	4-2-28	1N4567	4-3-15	1N4703	4-2-30
1N960B	4-2-28	1N4567A	4-3-15	1N4704	4-2-30
1N961B	4-2-28	1N4568	4-3-15	1N4705	4-2-30
1N962B	4-2-28	1N4568A	4-3-15	1N4706	4-2-30
1N963B	4-2-28	1N4569	4-3-15	1N4707	4-2-30
1N964B	4-2-28	1N4569A	4-3-15	1N4708	4-2-30
1N965B	4-2-28	1N4570	4-3-15	1N4709	4-2-30
1N966B	4-2-28	1N4570A	4-3-15	1N4710	4-2-30

ALPHANUMERIC INDEX (continued)

DEVICE	PAGE	DEVICE	PAGE	DEVICE	PAGE
1N4711	4-2-30	1N4762A	4-2-44	1N5259B	4-2-31
1N4712	4-2-30	1N4763A	4-2-44	1N5260B	4-2-31
1N4713	4-2-30	1N4764A	4-2-44	1N5261B	4-2-31
1N4714	4-2-30	1N5221B	4-2-31	1N5262B	4-2-31
1N4715	4-2-30	1N5222B	4-2-31	1N5263B	4-2-31
1N4716	4-2-30	1N5223B	4-2-31	1N5264B	4-2-31
1N4717	4-2-30	1N5224B	4-2-31	1N5265B	4-2-31
1N4728A	4-2-44	1N5225B	4-2-31	1N5266B	4-2-32
1N4729A	4-2-44	1N5226B	4-2-31	1N5267B	4-2-32
1N4730A	4-2-44	1N5227B	4-2-31	1N5268B	4-2-32
1N4731A	4-2-44	1N5228B	4-2-31	1N5269B	4-2-32
1N4732A	4-2-44	1N5229B	4-2-31	1N5270B	4-2-32
1N4733A	4-2-44	1N5230B	4-2-31	1N5271B	4-2-32
1N4734A	4-2-44	1N5231B	4-2-31	1N5272B	4-2-32
1N4735A	4-2-44	1N5232B	4-2-31	1N5273B	4-2-32
1N4736A	4-2-44	1N5233B	4-2-31	1N5274B	4-2-32
1N4737A	4-2-44	1N5234B	4-2-31	1N5275B	4-2-32
1N4738A	4-2-44	1N5235B	4-2-31	1N5276B	4-2-32
1N4739A	4-2-44	1N5236B	4-2-31	1N5277B	4-2-32
1N4740A	4-2-44	1N5237B	4-2-31	1N5278B	4-2-32
1N4741A	4-2-44	1N5238B	4-2-31	1N5279B	4-2-32
1N4742A	4-2-44	1N5239B	4-2-31	1N5280B	4-2-32
1N4743A	4-2-44	1N5240B	4-2-31	1N5281B	4-2-32
1N4744A	4-2-44	1N5241B	4-2-31	1N5333B	4-2-59
1N4745A	4-2-44	1N5242B	4-2-31	1N5334B	4-2-59
1N4746A	4-2-44	1N5243B	4-2-31	1N5335B	4-2-59
1N4747A	4-2-44	1N5244B	4-2-31	1N5336B	4-2-59
1N4748A	4-2-44	1N5245B	4-2-31	1N5337B	4-2-59
1N4749A	4-2-44	1N5246B	4-2-31	1N5338B	4-2-59
1N4750A	4-2-44	1N5247B	4-2-31	1N5339B	4-2-59
1N4751A	4-2-44	1N5248B	4-2-31	1N5340B	4-2-59
1N4752A	4-2-44	1N5249B	4-2-31	1N5341B	4-2-59
1N4753A	4-2-44	1N5250B	4-2-31	1N5342B	4-2-59
1N4754A	4-2-44	1N5251B	4-2-31	1N5343B	4-2-59
1N4755A	4-2-44	1N5252B	4-2-31	1N5344B	4-2-59
1N4756A	4-2-44	1N5253B	4-2-31	1N5345B	4-2-59
1N4757A	4-2-44	1N5254B	4-2-31	1N5346B	4-2-59
1N4758A	4-2-44	1N5255B	4-2-31	1N5347B	4-2-59
1N4759A	4-2-44	1N5256B	4-2-31	1N5348B	4-2-59
1N4760A	4-2-44	1N5257B	4-2-31	1N5349B	4-2-59
1N4761A	4-2-44	1N5258B	4-2-31	1N5350B	4-2-59

1

ALPHANUMERIC INDEX (continued)

DEVICE	PAGE	DEVICE	PAGE	DEVICE	PAGE
1N5351B	4-2-59	1N5915B	4-2-51	1N5956B	4-2-52
1N5352B	4-2-59	1N5916B	4-2-51	1N5985B	4-2-33
1N5353B	4-2-59	1N5917B	4-2-51	1N5986B	4-2-33
1N5354B	4-2-59	1N5918B	4-2-51	1N5987B	4-2-33
1N5355B	4-2-59	1N5919B	4-2-51	1N5988B	4-2-33
1N5356B	4-2-59	1N5920B	4-2-51	1N5989B	4-2-33
1N5357B	4-2-59	1N5921B	4-2-51	1N5990B	4-2-33
1N5358B	4-2-59	1N5922B	4-2-51	1N5991B	4-2-33
1N5359B	4-2-59	1N5923B	4-2-51	1N5992B	4-2-33
1N5360B	4-2-59	1N5924B	4-2-51	1N5993B	4-2-33
1N5361B	4-2-59	1N5925B	4-2-51	1N5994B	4-2-33
1N5362B	4-2-59	1N5926B	4-2-51	1N5995B	4-2-33
1N5363B	4-2-59	1N5927B	4-2-51	1N5996B	4-2-33
1N5364B	4-2-59	1N5928B	4-2-51	1N5997B	4-2-33
1N5365B	4-2-59	1N5929B	4-2-51	1N5998B	4-2-33
1N5366B	4-2-59	1N5930B	4-2-51	1N5999B	4-2-33
1N5367B	4-2-59	1N5931B	4-2-51	1N6000B	4-2-33
1N5368B	4-2-59	1N5932B	4-2-51	1N6001B	4-2-33
1N5369B	4-2-59	1N5933B	4-2-51	1N6002B	4-2-33
1N5370B	4-2-59	1N5934B	4-2-51	1N6003B	4-2-33
1N5371B	4-2-59	1N5935B	4-2-51	1N6004B	4-2-33
1N5372B	4-2-59	1N5936B	4-2-51	1N6005B	4-2-33
1N5373B	4-2-59	1N5937B	4-2-51	1N6006B	4-2-33
1N5374B	4-2-59	1N5938B	4-2-51	1N6007B	4-2-33
1N5375B	4-2-59	1N5939B	4-2-51	1N6008B	4-2-33
1N5376B	4-2-59	1N5940B	4-2-51	1N6009B	4-2-33
1N5377B	4-2-59	1N5941B	4-2-51	1N6010B	4-2-33
1N5378B	4-2-59	1N5942B	4-2-51	1N6011B	4-2-33
1N5379B	4-2-59	1N5943B	4-2-51	1N6012B	4-2-33
1N5380B	4-2-59	1N5944B	4-2-51	1N6013B	4-2-33
1N5381B	4-2-59	1N5945B	4-2-51	1N6014B	4-2-33
1N5382B	4-2-59	1N5946B	4-2-51	1N6015B	4-2-33
1N5383B	4-2-60	1N5947B	4-2-51	1N6016B	4-2-33
1N5384B	4-2-60	1N5948B	4-2-52	1N6017B	4-2-33
1N5385B	4-2-60	1N5949B	4-2-52	1N6018B	4-2-33
1N5386B	4-2-60	1N5950B	4-2-52	1N6019B	4-2-33
1N5387B	4-2-60	1N5951B	4-2-52	1N6020B	4-2-33
1N5388B	4-2-60	1N5952B	4-2-52	1N6021B	4-2-33
1N5908	4-1-42	1N5953B	4-2-52	1N6022B	4-2-33
1N5913B	4-2-51	1N5954B	4-2-52	1N6023B	4-2-33
1N5914B	4-2-51	1N5955B	4-2-52	1N6024B	4-2-33

ALPHANUMERIC INDEX (continued)

DEVICE	PAGE	DEVICE	PAGE	DEVICE	PAGE
1N6025B	4-2-33	1N6287	4-1-43	1N6380	4-1-46
1N6267	4-1-43	1N6287A	4-1-43	1N6381	4-1-46
1N6267A	4-1-43	1N6288	4-1-43	1N6382	4-1-46
1N6268	4-1-43	1N6288A	4-1-43	1N6383	4-1-46
1N6268A	4-1-43	1N6289	4-1-44	1N6384	4-1-46
1N6269	4-1-43	1N6289A	4-1-44	1N6385	4-1-46
1N6269A	4-1-43	1N6290	4-1-44	1N6386	4-1-46
1N6270	4-1-43	1N6290A	4-1-44	1N6387	4-1-46
1N6270A	4-1-43	1N6291	4-1-44	1N6388	4-1-46
1N6271	4-1-43	1N6291A	4-1-44	1N6389	4-1-46
1N6271A	4-1-43	1N6292	4-1-44	1SMB5.0AT3	4-1-59
1N6272	4-1-43	1N6292A	4-1-44	1SMB6.0AT3	4-1-59
1N6272A	4-1-43	1N6293	4-1-44	1SMB6.5AT3	4-1-59
1N6273	4-1-43	1N6293A	4-1-44	1SMB7.0AT3	4-1-59
1N6273A	4-1-43	1N6294	4-1-44	1SMB7.5AT3	4-1-59
1N6274	4-1-43	1N6294A	4-1-44	1SMB8.0AT3	4-1-59
1N6274A	4-1-43	1N6295	4-1-44	1SMB8.5AT3	4-1-59
1N6275	4-1-43	1N6295A	4-1-44	1SMB9.0AT3	4-1-59
1N6275A	4-1-43	1N6296	4-1-44	1SMB10AT3	4-1-59
1N6276	4-1-43	1N6296A	4-1-44	1SMB11AT3	4-1-59
1N6276A	4-1-43	1N6297	4-1-44	1SMB12AT3	4-1-59
1N6277	4-1-43	1N6297A	4-1-44	1SMB13AT3	4-1-59
1N6277A	4-1-43	1N6298	4-1-44	1SMB14AT3	4-1-59
1N6278	4-1-43	1N6298A	4-1-44	1SMB15AT3	4-1-59
1N6278A	4-1-43	1N6299	4-1-44	1SMB16AT3	4-1-59
1N6279	4-1-43	1N6299A	4-1-44	1SMB17AT3	4-1-59
1N6279A	4-1-43	1N6300	4-1-44	1SMB18AT3	4-1-59
1N6280	4-1-43	1N6300A	4-1-44	1SMB20AT3	4-1-59
1N6280A	4-1-43	1N6301	4-1-44	1SMB22AT3	4-1-59
1N6281	4-1-43	1N6301A	4-1-44	1SMB24AT3	4-1-59
1N6281A	4-1-43	1N6302	4-1-44	1SMB26AT3	4-1-59
1N6282	4-1-43	1N6302A	4-1-44	1SMB28AT3	4-1-59
1N6282A	4-1-43	1N6303	4-1-44	1SMB30AT3	4-1-59
1N6283	4-1-43	1N6303A	4-1-44	1SMB33AT3	4-1-59
1N6283A	4-1-43	1N6373	4-1-46	1SMB36AT3	4-1-59
1N6284	4-1-43	1N6374	4-1-46	1SMB40AT3	4-1-59
1N6284A	4-1-43	1N6375	4-1-46	1SMB43AT3	4-1-59
1N6285	4-1-43	1N6376	4-1-46	1SMB45AT3	4-1-59
1N6285A	4-1-43	1N6377	4-1-46	1SMB48AT3	4-1-59
1N6286	4-1-43	1N6378	4-1-46	1SMB51AT3	4-1-59
1N6286A	4-1-43	1N6379	4-1-46	1SMB54AT3	4-1-59



ALPHANUMERIC INDEX (continued)

DEVICE	PAGE	DEVICE	PAGE	DEVICE	PAGE
1SMB58AT3	4-1-59	1SMB5939BT3	4-2-79	1SMC33AT3	4-1-65
1SMB60AT3	4-1-59	1SMB5940BT3	4-2-79	1SMC36AT3	4-1-65
1SMB64AT3	4-1-59	1SMB5941BT3	4-2-79	1SMC40AT3	4-1-65
1SMB70AT3	4-1-59	1SMB5942BT3	4-2-79	1SMC43AT3	4-1-65
1SMB75AT3	4-1-59	1SMB5943BT3	4-2-79	1SMC45AT3	4-1-65
1SMB78AT3	4-1-59	1SMB5944BT3	4-2-79	1SMC48AT3	4-1-65
1SMB85AT3	4-1-59	1SMB5945BT3	4-2-79	1SMC51AT3	4-1-65
1SMB90AT3	4-1-59	1SMB5946BT3	4-2-79	1SMC54AT3	4-1-65
1SMB100AT3	4-1-59	1SMB5947BT3	4-2-79	1SMC58AT3	4-1-65
1SMB110AT3	4-1-59	1SMB5948BT3	4-2-79	1SMC60AT3	4-1-65
1SMB120AT3	4-1-59	1SMB5949BT3	4-2-79	1SMC64AT3	4-1-65
1SMB130AT3	4-1-59	1SMB5950BT3	4-2-79	1SMC70AT3	4-1-65
1SMB150AT3	4-1-59	1SMB5951BT3	4-2-79	1SMC75AT3	4-1-65
1SMB160AT3	4-1-59	1SMB5952BT3	4-2-79	1SMC78AT3	4-1-65
1SMB170AT3	4-1-59	1SMB5953BT3	4-2-79	1.5KE6.8	4-1-43
1SMB5913BT3	4-2-78	1SMB5954BT3	4-2-79	1.5KE6.8A	4-1-43
1SMB5914BT3	4-2-78	1SMB5955BT3	4-2-79	1.5KE7.5	4-1-43
1SMB5915BT3	4-2-78	1SMB5956BT3	4-2-79	1.5KE7.5A	4-1-43
1SMB5916BT3	4-2-78	1SMC5.0AT3	4-1-65	1.5KE8.2	4-1-43
1SMB5917BT3	4-2-78	1SMC6.0AT3	4-1-65	1.5KE8.2A	4-1-43
1SMB5918BT3	4-2-78	1SMC6.5AT3	4-1-65	1.5KE9.1	4-1-43
1SMB5919BT3	4-2-78	1SMC7.0AT3	4-1-65	1.5KE9.1A	4-1-43
1SMB5920BT3	4-2-78	1SMC7.5AT3	4-1-65	1.5KE10	4-1-43
1SMB5921BT3	4-2-78	1SMC8.0AT3	4-1-65	1.5KE10A	4-1-43
1SMB5922BT3	4-2-78	1SMC8.5AT3	4-1-65	1.5KE11	4-1-43
1SMB5923BT3	4-2-78	1SMC9.0AT3	4-1-65	1.5KE11A	4-1-43
1SMB5924BT3	4-2-78	1SMC10AT3	4-1-65	1.5KE12	4-1-43
1SMB5925BT3	4-2-78	1SMC11AT3	4-1-65	1.5KE12A	4-1-43
1SMB5926BT3	4-2-78	1SMC12AT3	4-1-65	1.5KE13	4-1-43
1SMB5927BT3	4-2-78	1SMC13AT3	4-1-65	1.5KE13A	4-1-43
1SMB5928BT3	4-2-78	1SMC14AT3	4-1-65	1.5KE15	4-1-43
1SMB5929BT3	4-2-79	1SMC15AT3	4-1-65	1.5KE15A	4-1-43
1SMB5930BT3	4-2-79	1SMC16AT3	4-1-65	1.5KE16	4-1-43
1SMB5931BT3	4-2-79	1SMC17AT3	4-1-65	1.5KE16A	4-1-43
1SMB5932BT3	4-2-79	1SMC18AT3	4-1-65	1.5KE18	4-1-43
1SMB5933BT3	4-2-79	1SMC20AT3	4-1-65	1.5KE18A	4-1-43
1SMB5934BT3	4-2-79	1SMC22AT3	4-1-65	1.5KE20	4-1-43
1SMB5935BT3	4-2-79	1SMC24AT3	4-1-65	1.5KE20A	4-1-43
1SMB5936BT3	4-2-79	1SMC26AT3	4-1-65	1.5KE22	4-1-43
1SMB5937BT3	4-2-79	1SMC28AT3	4-1-65	1.5KE22A	4-1-43
1SMB5938BT3	4-2-79	1SMC30AT3	4-1-65	1.5KE24	4-1-43

ALPHANUMERIC INDEX (continued)

DEVICE	PAGE	DEVICE	PAGE	DEVICE	PAGE
1.5KE24A	4-1-43	1.5KE170	4-1-44	3EZ5.1D5	4-2-53
1.5KE27	4-1-43	1.5KE170A	4-1-44	3EZ5.6D5	4-2-53
1.5KE27A	4-1-43	1.5KE180	4-1-44	3EZ6.2D5	4-2-53
1.5KE30	4-1-43	1.5KE180A	4-1-44	3EZ6.8D5	4-2-53
1.5KE30A	4-1-43	1.5KE200	4-1-44	3EZ7.5D5	4-2-53
1.5KE33	4-1-43	1.5KE200A	4-1-44	3EZ8.2D5	4-2-53
1.5KE33A	4-1-43	1.5KE220	4-1-44	3EZ9.1D5	4-2-53
1.5KE36	4-1-43	1.5KE220A	4-1-44	3EZ10D5	4-2-53
1.5KE36A	4-1-43	1.5KE250	4-1-44	3EZ11D5	4-2-53
1.5KE39	4-1-43	1.5KE250A	4-1-44	3EZ12D5	4-2-53
1.5KE39A	4-1-43	1.5SMC6.8AT3	4-1-66	3EZ13D5	4-2-53
1.5KE43	4-1-43	1.5SMC7.5AT3	4-1-66	3EZ14D5	4-2-53
1.5KE43A	4-1-43	1.5SMC8.2AT3	4-1-66	3EZ15D5	4-2-53
1.5KE47	4-1-43	1.5SMC9.1AT3	4-1-66	3EZ16D5	4-2-53
1.5KE47A	4-1-43	1.5SMC10AT3	4-1-66	3EZ17D5	4-2-53
1.5KE51	4-1-43	1.5SMC11AT3	4-1-66	3EZ18D5	4-2-53
1.5KE51A	4-1-43	1.5SMC12AT3	4-1-66	3EZ19D5	4-2-53
1.5KE56	4-1-44	1.5SMC13AT3	4-1-66	3EZ20D5	4-2-53
1.5KE56A	4-1-44	1.5SMC15AT3	4-1-66	3EZ22D5	4-2-53
1.5KE62	4-1-44	1.5SMC16AT3	4-1-66	3EZ24D5	4-2-53
1.5KE62A	4-1-44	1.5SMC18AT3	4-1-66	3EZ27D5	4-2-53
1.5KE68	4-1-44	1.5SMC20AT3	4-1-66	3EZ28D5	4-2-53
1.5KE68A	4-1-44	1.5SMC22AT3	4-1-66	3EZ30D5	4-2-53
1.5KE75	4-1-44	1.5SMC24AT3	4-1-66	3EZ33D5	4-2-53
1.5KE75A	4-1-44	1.5SMC27AT3	4-1-66	3EZ36D5	4-2-53
1.5KE82	4-1-44	1.5SMC30AT3	4-1-66	3EZ39D5	4-2-53
1.5KE82A	4-1-44	1.5SMC33AT3	4-1-66	3EZ43D5	4-2-53
1.5KE91	4-1-44	1.5SMC36AT3	4-1-66	3EZ47D5	4-2-53
1.5KE91A	4-1-44	1.5SMC39AT3	4-1-66	3EZ51D5	4-2-53
1.5KE100	4-1-44	1.5SMC43AT3	4-1-66	3EZ56D5	4-2-53
1.5KE100A	4-1-44	1.5SMC47AT3	4-1-66	3EZ62D5	4-2-53
1.5KE110	4-1-44	1.5SMC51AT3	4-1-66	3EZ68D5	4-2-53
1.5KE110A	4-1-44	1.5SMC56AT3	4-1-66	3EZ75D5	4-2-53
1.5KE120	4-1-44	1.5SMC62AT3	4-1-66	3EZ82D5	4-2-53
1.5KE120A	4-1-44	1.5SMC68AT3	4-1-66	3EZ91D5	4-2-53
1.5KE130	4-1-44	1.5SMC75AT3	4-1-66	3EZ100D5	4-2-53
1.5KE130A	4-1-44	1.5SMC82AT3	4-1-66	3EZ110D5	4-2-53
1.5KE150	4-1-44	1.5SMC91T3	4-1-66	3EZ120D5	4-2-53
1.5KE150A	4-1-44	3EZ3.9D5	4-2-53	3EZ130D5	4-2-53
1.5KE160	4-1-44	3EZ4.3D5	4-2-53	3EZ140D5	4-2-53
1.5KE160A	4-1-44	3EZ4.7D5	4-2-53	3EZ150D5	4-2-53



ALPHANUMERIC INDEX (continued)

DEVICE	PAGE	DEVICE	PAGE	DEVICE	PAGE
3EZ160D5	4-2-53	BZV55C39	4-2-73	BZX55C82	4-2-34
3EZ170D5	4-2-53	BZV55C43	4-2-73	BZX55C91	4-2-34
3EZ180D5	4-2-53	BZV55C47	4-2-73	BZX79C2V4	4-2-35
3EZ190D5	4-2-53	BZV55C51	4-2-73	BZX79C2V7	4-2-35
3EZ200D5	4-2-54	BZV55C56	4-2-73	BZX79C3V0	4-2-35
3EZ220D5	4-2-54	BZX55C2V4	4-2-34	BZX79C3V6	4-2-35
3EZ240D5	4-2-54	BZX55C2V7	4-2-34	BZX79C3V9	4-2-35
3EZ270D5	4-2-54	BZX55C3V0	4-2-34	BZX79C4V3	4-2-35
3EZ300D5	4-2-54	BZX55C3V3	4-2-34	BZX79C5V1	4-2-35
3EZ330D5	4-2-54	BZX55C3V6	4-2-34	BZX79C5V6	4-2-35
3EZ360D5	4-2-54	BZX55C3V9	4-2-34	BZX79C6V2	4-2-35
3EZ400D5	4-2-54	BZX55C4V3	4-2-34	BZX79C6V8	4-2-35
BZV55C2V4	4-2-73	BZX55C4V7	4-2-34	BZX79C7V5	4-2-35
BZV55C2V7	4-2-73	BZX55C5V1	4-2-34	BZX79C8V2	4-2-35
BZV55C3V0	4-2-73	BZX55C5V6	4-2-34	BZX79C9V1	4-2-35
BZV55C3V3	4-2-73	BZX55C6V2	4-2-34	BZX79C10	4-2-35
BZV55C3V6	4-2-73	BZX55C6V8	4-2-34	BZX79C11	4-2-35
BZV55C3V9	4-2-73	BZX55C7V5	4-2-34	BZX79C12	4-2-35
BZV55C4V3	4-2-73	BZX55C8V2	4-2-34	BZX79C13	4-2-35
BZV55C4V7	4-2-73	BZX55C9V1	4-2-34	BZX79C15	4-2-35
BZV55C5V1	4-2-73	BZX55C10	4-2-34	BZX79C16	4-2-35
BZV55C5V6	4-2-73	BZX55C11	4-2-34	BZX79C18	4-2-35
BZV55C6V2	4-2-73	BZX55C12	4-2-34	BZX79C20	4-2-35
BZV55C6V8	4-2-73	BZX55C13	4-2-34	BZX79C22	4-2-35
BZV55C7V5	4-2-73	BZX55C15	4-2-34	BZX79C24	4-2-35
BZV55C8V2	4-2-73	BZX55C16	4-2-34	BZX79C27	4-2-35
BZV55C9V1	4-2-73	BZX55C18	4-2-34	BZX79C30	4-2-35
BZV55C10	4-2-73	BZX55C20	4-2-34	BZX79C33	4-2-35
BZV55C11	4-2-73	BZX55C22	4-2-34	BZX79C36	4-2-35
BZV55C12	4-2-73	BZX55C24	4-2-34	BZX79C39	4-2-35
BZV55C13	4-2-73	BZX55C27	4-2-34	BZX79C43	4-2-35
BZV55C15	4-2-73	BZX55C30	4-2-34	BZX79C47	4-2-35
BZV55C16	4-2-73	BZX55C33	4-2-34	BZX79C51	4-2-35
BZV55C18	4-2-73	BZX55C36	4-2-34	BZX79C56	4-2-35
BZV55C20	4-2-73	BZX55C39	4-2-34	BZX79C62	4-2-35
BZV55C22	4-2-73	BZX55C43	4-2-34	BZX79C68	4-2-35
BZV55C24	4-2-73	BZX55C47	4-2-34	BZX79C75	4-2-35
BZV55C27	4-2-73	BZX55C51	4-2-34	BZX79C82	4-2-35
BZV55C30	4-2-73	BZX55C56	4-2-34	BZX79C91	4-2-35
BZV55C33	4-2-73	BZX55C62	4-2-34	BZX79C100	4-2-35
BZV55C36	4-2-73	BZX55C68	4-2-34	BZX79C110	4-2-35

ALPHANUMERIC INDEX (continued)

DEVICE	PAGE	DEVICE	PAGE	DEVICE	PAGE
BZX79C120	4-2-35	BZX84C5V1L	4-2-65	BZX85C10	4-2-45
BZX79C130	4-2-35	BZX84C5V6L	4-2-65	BZX85C11	4-2-45
BZX79C150	4-2-35	BZX84C6V2L	4-2-65	BZX85C12	4-2-45
BZX79C160	4-2-35	BZX84C6V8L	4-2-65	BZX85C13	4-2-45
BZX79C180	4-2-35	BZX84C7V5L	4-2-65	BZX85C15	4-2-45
BZX79C200	4-2-35	BZX84C8V2L	4-2-65	BZX85C16	4-2-45
BZX83C2V7	4-2-36	BZX84C9V1L	4-2-65	BZX85C18	4-2-45
BZX83C3V0	4-2-36	BZX84C10L	4-2-65	BZX85C20	4-2-45
BZX83C3V3	4-2-36	BZX84C11L	4-2-65	BZX85C22	4-2-45
BZX83C3V6	4-2-36	BZX84C12L	4-2-65	BZX85C24	4-2-45
BZX83C3V9	4-2-36	BZX84C13L	4-2-65	BZX85C27	4-2-45
BZX83C4V3	4-2-36	BZX84C15L	4-2-65	BZX85C30	4-2-45
BZX83C4V7	4-2-36	BZX84C16L	4-2-65	BZX85C33	4-2-45
BZX83C5V1	4-2-36	BZX84C18L	4-2-65	BZX85C36	4-2-45
BZX83C5V6	4-2-36	BZX84C20L	4-2-65	BZX85C39	4-2-45
BZX83C6V2	4-2-36	BZX84C22L	4-2-65	BZX85C43	4-2-45
BZX83C6V8	4-2-36	BZX84C24L	4-2-65	BZX85C47	4-2-45
BZX83C7V5	4-2-36	BZX84C27L	4-2-65	BZX85C51	4-2-45
BZX83C8V2	4-2-36	BZX84C30L	4-2-65	BZX85C56	4-2-45
BZX83C9V1	4-2-36	BZX84C33L	4-2-65	BZX85C62	4-2-45
BZX83C10	4-2-36	BZX84C36L	4-2-65	BZX85C68	4-2-45
BZX83C11	4-2-36	BZX84C39L	4-2-65	BZX85C75	4-2-45
BZX83C12	4-2-36	BZX84C43L	4-2-65	BZX85C82	4-2-45
BZX83C13	4-2-36	BZX84C47L	4-2-65	BZX85C91	4-2-45
BZX83C15	4-2-36	BZX84C51L	4-2-65	BZX85C100	4-2-45
BZX83C16	4-2-36	BZX84C56L	4-2-65	ICTE-5	4-1-46
BZX83C18	4-2-36	BZX84C62L	4-2-65	ICTE-8	4-1-46
BZX83C20	4-2-36	BZX84C68L	4-2-65	ICTE-8C	4-1-46
BZX83C22	4-2-36	BZX84C75L	4-2-65	ICTE-10	4-1-46
BZX83C24	4-2-36	BZX85C3V3	4-2-45	ICTE-10C	4-1-46
BZX83C27	4-2-36	BZX85C3V6	4-2-45	ICTE-12	4-1-46
BZX83C30	4-2-36	BZX85C3V9	4-2-45	ICTE-12C	4-1-46
BZX83C33	4-2-36	BZX85C4V3	4-2-45	ICTE-15	4-1-46
BZX84C2V4L	4-2-65	BZX85C4V7	4-2-45	ICTE-15C	4-1-46
BZX84C2V7L	4-2-65	BZX85C5V1	4-2-45	ICTE-18	4-1-46
BZX84C3V0L	4-2-65	BZX85C5V6	4-2-45	ICTE-18C	4-1-46
BZX84C3V3L	4-2-65	BZX85C6V2	4-2-45	ICTE-22	4-1-46
BZX84C3V6L	4-2-65	BZX85C6V8	4-2-45	ICTE-22C	4-1-46
BZX84C3V9L	4-2-65	BZX85C7V5	4-2-45	ICTE-36	4-1-46
BZX84C4V3L	4-2-65	BZX85C8V2	4-2-45	ICTE-36C	4-1-46
BZX84C4V7L	4-2-65	BZX85C9V1	4-2-45	ICTE-45	4-1-46



ALPHANUMERIC INDEX (continued)

DEVICE	PAGE	DEVICE	PAGE	DEVICE	PAGE
ICTE-45C	4-1-46	MLL5221B	4-2-75	MLL5263B	4-2-75
MLL4678	4-2-74	MLL5222B	4-2-75	MMBZ15VDLT1	4-1-52
MLL4679	4-2-74	MLL5223B	4-2-75	MMBZ5221BL	4-2-66
MLL4680	4-2-74	MLL5224B	4-2-75	MMBZ5222BL	4-2-66
MLL4681	4-2-74	MLL5225B	4-2-75	MMBZ5223BL	4-2-66
MLL4682	4-2-74	MLL5226B	4-2-75	MMBZ5224BL	4-2-66
MLL4683	4-2-74	MLL5227B	4-2-75	MMBZ5225BL	4-2-66
MLL4684	4-2-74	MLL5228B	4-2-75	MMBZ5226BL	4-2-66
MLL4685	4-2-74	MLL5229B	4-2-75	MMBZ5227BL	4-2-66
MLL4686	4-2-74	MLL5230B	4-2-75	MMBZ5228BL	4-2-66
MLL4687	4-2-74	MLL5231B	4-2-75	MMBZ5229BL	4-2-66
MLL4688	4-2-74	MLL5232B	4-2-75	MMBZ5230BL	4-2-66
MLL4689	4-2-74	MLL5233B	4-2-75	MMBZ5231BL	4-2-66
MLL4690	4-2-74	MLL5234B	4-2-75	MMBZ5232BL	4-2-66
MLL4691	4-2-74	MLL5235B	4-2-75	MMBZ5233BL	4-2-66
MLL4692	4-2-74	MLL5236B	4-2-75	MMBZ5234BL	4-2-66
MLL4693	4-2-74	MLL5237B	4-2-75	MMBZ5235BL	4-2-66
MLL4694	4-2-74	MLL5238B	4-2-75	MMBZ5236BL	4-2-66
MLL4695	4-2-74	MLL5239B	4-2-75	MMBZ5237BL	4-2-66
MLL4696	4-2-74	MLL5240B	4-2-75	MMBZ5238BL	4-2-66
MLL4697	4-2-74	MLL5241B	4-2-75	MMBZ5239BL	4-2-66
MLL4698	4-2-74	MLL5242B	4-2-75	MMBZ5240BL	4-2-66
MLL4699	4-2-74	MLL5243B	4-2-75	MMBZ5241BL	4-2-66
MLL4700	4-2-74	MLL5244B	4-2-75	MMBZ5242BL	4-2-66
MLL4701	4-2-74	MLL5245B	4-2-75	MMBZ5243BL	4-2-66
MLL4702	4-2-74	MLL5246B	4-2-75	MMBZ5244BL	4-2-66
MLL4703	4-2-74	MLL5247B	4-2-75	MMBZ5245BL	4-2-66
MLL4704	4-2-74	MLL5248B	4-2-75	MMBZ5246BL	4-2-66
MLL4705	4-2-74	MLL5249B	4-2-75	MMBZ5247BL	4-2-66
MLL4706	4-2-74	MLL5250B	4-2-75	MMBZ5248BL	4-2-66
MLL4707	4-2-74	MLL5251B	4-2-75	MMBZ5249BL	4-2-66
MLL4708	4-2-74	MLL5252B	4-2-75	MMBZ5250BL	4-2-66
MLL4709	4-2-74	MLL5253B	4-2-75	MMBZ5251BL	4-2-66
MLL4710	4-2-74	MLL5254B	4-2-75	MMBZ5252BL	4-2-66
MLL4711	4-2-74	MLL5255B	4-2-75	MMBZ5253BL	4-2-66
MLL4712	4-2-74	MLL5256B	4-2-75	MMBZ5254BL	4-2-66
MLL4713	4-2-74	MLL5257B	4-2-75	MMBZ5255BL	4-2-66
MLL4714	4-2-74	MLL5258B	4-2-75	MMBZ5256BL	4-2-66
MLL4715	4-2-74	MLL5259B	4-2-75	MMBZ5257BL	4-2-66
MLL4716	4-2-74	MLL5260B	4-2-75	MMBZ5258BL	4-2-66
MLL4717	4-2-74	MLL5261B	4-2-75	MMBZ5259BL	4-2-66

ALPHANUMERIC INDEX (continued)

DEVICE	PAGE	DEVICE	PAGE	DEVICE	PAGE
MMBZ5260BL	4-2-66	MZ4620	4-2-37	MZD33	4-2-55
MMBZ5261BL	4-2-66	MZ4621	4-2-37	MZD36	4-2-55
MMBZ5262BL	4-2-66	MZ4622	4-2-37	MZD39	4-2-55
MMBZ5263BL	4-2-66	MZ4623	4-2-37	MZD43	4-2-55
MMBZ5264BL	4-2-66	MZ4624	4-2-37	MZD47	4-2-55
MMBZ5265BL	4-2-66	MZ4625	4-2-37	MZD51	4-2-55
MMBZ5266BL	4-2-66	MZ4626	4-2-37	MZD56	4-2-55
MMBZ5267BL	4-2-66	MZ4627	4-2-37	MZD62	4-2-55
MMBZ5268BL	4-2-66	MZ5520B	4-2-38	MZD68	4-2-55
MMBZ5269BL	4-2-66	MZ5521B	4-2-38	MZD75	4-2-55
MMBZ5270BL	4-2-66	MZ5522B	4-2-38	MZD82	4-2-55
MPTE-5	4-1-46	MZ5523B	4-2-38	MZD91	4-2-55
MPTE-8	4-1-46	MZ5524B	4-2-38	MZD100	4-2-55
MPTE-8C	4-1-46	MZ5525B	4-2-38	MZD110	4-2-55
MPTE-10	4-1-46	MZ5526B	4-2-38	MZD120	4-2-55
MPTE-10C	4-1-46	MZ5527B	4-2-38	MZD130	4-2-55
MPTE-12	4-1-46	MZ5528B	4-2-38	MZD150	4-2-55
MPTE-12C	4-1-46	MZ5529B	4-2-38	MZD160	4-2-55
MPTE-15	4-1-46	MZ5530B	4-2-38	MZD180	4-2-55
MPTE-15C	4-1-46	MZD3.9	4-2-55	MZD200	4-2-55
MPTE-18	4-1-46	MZD4.3	4-2-55	MZP4728A	4-2-56
MPTE-18C	4-1-46	MZD4.7	4-2-55	MZP4729A	4-2-56
MPTE-22	4-1-46	MZD5.1	4-2-55	MZP4730A	4-2-56
MPTE-22C	4-1-46	MZD5.6	4-2-55	MZP4731A	4-2-56
MPTE-36	4-1-46	MZD6.2	4-2-55	MZP4732A	4-2-56
MPTE-36C	4-1-46	MZD6.8	4-2-55	MZP4733A	4-2-56
MPTE-45	4-1-46	MZD7.5	4-2-55	MZP4734A	4-2-56
MPTE-45C	4-1-46	MZD8.2	4-2-55	MZP4735A	4-2-56
MR2535L	4-1-48	MZD9.1	4-2-55	MZP4736A	4-2-56
MZ4099	4-2-37	MZD10	4-2-55	MZP4737A	4-2-56
MZ4100	4-2-37	MZD11	4-2-55	MZP4738A	4-2-56
MZ4101	4-2-37	MZD12	4-2-55	MZP4739A	4-2-56
MZ4102	4-2-37	MZD13	4-2-55	MZP4740A	4-2-56
MZ4103	4-2-37	MZD15	4-2-55	MZP4742A	4-2-56
MZ4104	4-2-37	MZD16	4-2-55	MZP4743A	4-2-56
MZ4614	4-2-37	MZD18	4-2-55	MZP4744A	4-2-56
MZ4615	4-2-37	MZD20	4-2-55	MZP4745A	4-2-56
MZ4616	4-2-37	MZD22	4-2-55	MZP4746A	4-2-56
MZ4617	4-2-37	MZD24	4-2-55	MZP4747A	4-2-56
MZ4618	4-2-37	MZD27	4-2-55	MZP4748A	4-2-56
MZ4619	4-2-37	MZD30	4-2-55	MZP4749A	4-2-56



ALPHANUMERIC INDEX (continued)

DEVICE	PAGE	DEVICE	PAGE	DEVICE	PAGE
MZP4750A	4-2-56	MZPY47	4-2-46	P6KE33A	4-1-33
MZP4751A	4-2-56	MZPY51	4-2-46	P6KE36	4-1-33
MZP4752A	4-2-56	MZPY56	4-2-46	P6KE36A	4-1-33
MZP4753A	4-2-56	MZPY62	4-2-46	P6KE39	4-1-33
MZP4754A	4-2-56	MZPY68	4-2-46	P6KE39A	4-1-33
MZP4755A	4-2-56	MZPY75	4-2-46	P6KE43	4-1-33
MZP4756A	4-2-56	MZPY82	4-2-46	P6KE43A	4-1-33
MZP4757A	4-2-56	MZPY91	4-2-46	P6KE47	4-1-33
MZP4758A	4-2-56	MZPY100	4-2-46	P6KE47A	4-1-33
MZP4759A	4-2-56	P6KE6.8	4-1-33	P6KE51	4-1-33
MZP4760A	4-2-56	P6KE6.8A	4-1-33	P6KE51A	4-1-33
MZP4761A	4-2-56	P6KE7.5	4-1-33	P6KE56	4-1-33
MZP4762A	4-2-56	P6KE7.5A	4-1-33	P6KE56A	4-1-33
MZP4763A	4-2-56	P6KE8.2	4-1-33	P6KE62	4-1-33
MZP4764A	4-2-56	P6KE8.2A	4-1-33	P6KE62A	4-1-33
MZPY3.9	4-2-46	P6KE9.1	4-1-33	P6KE68	4-1-34
MZPY4.3	4-2-46	P6KE9.1A	4-1-33	P6KE68A	4-1-34
MZPY4.7	4-2-46	P6KE10	4-1-33	P6KE75	4-1-34
MZPY5.1	4-2-46	P6KE10A	4-1-33	P6KE75A	4-1-34
MZPY5.6	4-2-46	P6KE11	4-1-33	P6KE82	4-1-34
MZPY6.2	4-2-46	P6KE11A	4-1-33	P6KE82A	4-1-34
MZPY6.8	4-2-46	P6KE12	4-1-33	P6KE91	4-1-34
MZPY7.5	4-2-46	P6KE12A	4-1-33	P6KE91A	4-1-34
MZPY8.2	4-2-46	P6KE13	4-1-33	P6KE100	4-1-34
MZPY9.1	4-2-46	P6KE13A	4-1-33	P6KE100A	4-1-34
MZPY10	4-2-46	P6KE15	4-1-33	P6KE110	4-1-34
MZPY11	4-2-46	P6KE15A	4-1-33	P6KE110A	4-1-34
MZPY12	4-2-46	P6KE16	4-1-33	P6KE120	4-1-34
MZPY13	4-2-46	P6KE16A	4-1-33	P6KE120A	4-1-34
MZPY15	4-2-46	P6KE18	4-1-33	P6KE130	4-1-34
MZPY16	4-2-46	P6KE18A	4-1-33	P6KE130A	4-1-34
MZPY18	4-2-46	P6KE20	4-1-33	P6KE150	4-1-34
MZPY20	4-2-46	P6KE20A	4-1-33	P6KE150A	4-1-34
MZPY22	4-2-46	P6KE22	4-1-33	P6KE160	4-1-34
MZPY24	4-2-46	P6KE22A	4-1-33	P6KE160A	4-1-34
MZPY27	4-2-46	P6KE24	4-1-33	P6KE170	4-1-34
MZPY30	4-2-46	P6KE24A	4-1-33	P6KE170A	4-1-34
MZPY33	4-2-46	P6KE27	4-1-33	P6KE180	4-1-34
MZPY36	4-2-46	P6KE27A	4-1-33	P6KE180A	4-1-34
MZPY39	4-2-46	P6KE30	4-1-33	P6KE200	4-1-34
MZPY43	4-2-46	P6KE33	4-1-33	P6KE200A	4-1-34

ALPHANUMERIC INDEX (continued)

DEVICE	PAGE	DEVICE	PAGE	DEVICE	PAGE
P6SMB6.8AT3	4-1-60	SA6.5	4-1-26	SA30A	4-1-26
P6SMB7.5AT3	4-1-60	SA6.5A	4-1-26	SA33	4-1-26
P6SMB8.2AT3	4-1-60	SA7.0	4-1-26	SA33A	4-1-26
P6SMB9.1AT3	4-1-60	SA7.0A	4-1-26	SA36	4-1-27
P6SMB10AT3	4-1-60	SA7.5	4-1-26	SA36A	4-1-27
P6SMB11AT3	4-1-60	SA7.5A	4-1-26	SA40	4-1-27
P6SMB12AT3	4-1-60	SA8.0	4-1-26	SA40A	4-1-27
P6SMB13AT3	4-1-60	SA8.0A	4-1-26	SA43	4-1-27
P6SMB15AT3	4-1-60	SA8.5	4-1-26	SA43A	4-1-27
P6SMB16AT3	4-1-60	SA8.5A	4-1-26	SA45	4-1-27
P6SMB18AT3	4-1-60	SA9.0	4-1-26	SA45A	4-1-27
P6SMB20AT3	4-1-60	SA9.0A	4-1-26	SA48	4-1-27
P6SMB22AT3	4-1-60	SA10	4-1-26	SA48A	4-1-27
P6SMB24AT3	4-1-60	SA10A	4-1-26	SA51	4-1-27
P6SMB27AT3	4-1-60	SA11	4-1-26	SA51A	4-1-27
P6SMB30AT3	4-1-60	SA11A	4-1-26	SA54	4-1-27
P6SMB33AT3	4-1-60	SA12	4-1-26	SA54A	4-1-27
P6SMB36AT3	4-1-60	SA12A	4-1-26	SA58	4-1-27
P6SMB39AT3	4-1-60	SA13	4-1-26	SA58A	4-1-27
P6SMB43AT3	4-1-60	SA13A	4-1-26	SA60	4-1-27
P6SMB47AT3	4-1-60	SA14	4-1-26	SA60A	4-1-27
P6SMB51AT3	4-1-60	SA14A	4-1-26	SA64	4-1-27
P6SMB56AT3	4-1-60	SA15	4-1-26	SA64A	4-1-27
P6SMB62AT3	4-1-60	SA15A	4-1-26	SA70	4-1-27
P6SMB68AT3	4-1-60	SA16	4-1-26	SA70A	4-1-27
P6SMB75AT3	4-1-60	SA16A	4-1-26	SA75	4-1-27
P6SMB82AT3	4-1-60	SA17	4-1-26	SA75A	4-1-27
P6SMB91AT3	4-1-60	SA17A	4-1-26	SA78	4-1-27
P6SMB100AT3	4-1-60	SA18	4-1-26	SA78A	4-1-27
P6SMB110AT3	4-1-60	SA18A	4-1-26	SA85	4-1-27
P6SMB120AT3	4-1-60	SA20	4-1-26	SA85A	4-1-27
P6SMB130AT3	4-1-60	SA20A	4-1-26	SA890	4-1-27
P6SMB150AT3	4-1-60	SA22	4-1-26	SA90A	4-1-27
P6SMB160AT3	4-1-60	SA22A	4-1-26	SA100	4-1-27
P6SMB170AT3	4-1-60	SA24	4-1-26	SA100A	4-1-27
P6SMB180AT3	4-1-60	SA24A	4-1-26	SA110	4-1-27
P6SMB200AT3	4-1-60	SA26	4-1-26	SA110A	4-1-27
SA5.0	4-1-26	SA26A	4-1-26	SA120	4-1-27
SA5.0A	4-1-26	SA28	4-1-26	SA120A	4-1-27
SA6.0	4-1-26	SA28A	4-1-26	SA130	4-1-27
SA6.0A	4-1-26	SA30	4-1-26	SA130A	4-1-27

1

ALPHANUMERIC INDEX (continued)

DEVICE	PAGE
SA150	4-1-27
SA150A	4-1-27
SA160	4-1-27
SA160A	4-1-27
SA170	4-1-27
SA170A	4-1-27
ZPD2.7	4-2-36
ZPD3.0	4-2-36
ZPD3.3	4-2-36
ZPD3.6	4-2-36
ZPD3.9	4-2-36

DEVICE	PAGE
ZPD4.3	4-2-36
ZPD4.7	4-2-36
ZPD5.1	4-2-36
ZPD5.6	4-2-36
ZPD6.2	4-2-36
ZPD6.8	4-2-36
ZPD7.5	4-2-36
ZPD8.2	4-2-36
ZPD9.1	4-2-36
ZPD10	4-2-36
ZPD11	4-2-36

DEVICE	PAGE
ZPD12	4-2-36
ZPD13	4-2-36
ZPD15	4-2-36
ZPD16	4-2-36
ZPD18	4-2-36
ZPD20	4-2-36
ZPD22	4-2-36
ZPD24	4-2-36
ZPD27	4-2-36
ZPD30	4-2-36
ZPD33	4-2-36

1

Cross Reference Guide

2

This Cross Reference Guide lists industry devices by the EIA, European, or in-house part number for which there is a direct or similar Motorola replacement. The replacement columns show direct or similar replacements. The similar device differs in electrical and/or case style from the referenced industry type number. Substitution acceptability can be determined by reviewing the Electrical Characteristics and Case Dimensions given on the Motorola Data Sheet. For devices not shown in this Cross Reference Guide, or for further information, the user should contact a Motorola factory representative.

CROSS-REFERENCE (continued)

Industry Part Number	Motorola Direct Replacement	Motorola Similar Replacement	Page Number
4T110		1N5272A	4-2-32
4T110A		1N5272A	4-2-32
4T110B		1N5272B	4-2-32
4T12		1N5242A	4-2-31
4T12A		1N5242A	4-2-31
4T12B		1N5242B	4-2-31
4T5.6		1N5232A	4-2-31
4T5.6A		1N5232A	4-2-31
4T5.6B		1N5232B	4-2-31
4T6.8		1N5235A	4-2-31
4T6.8A		1N5235A	4-2-31
4T6.8B		1N5235B	4-2-31
4Z110D		1N5272A	4-2-32
4Z110D10		1N5272A	4-2-32
4Z110D5		1N5272B	4-2-32
4Z6.8D		1N5235A	4-2-31
4Z6.8D10		1N5235A	4-2-31
4Z6.8D5		1N5235B	4-2-31
5M110Z10	1N5272A		4-2-32
5M110Z5	1N5272B		4-2-32
5M110ZS	1N5272A		4-2-32
5M2.4ZS	1N5221A		4-2-31
5M2.4ZS10	1N5221A		4-2-31
5M2.4ZS5	1N5221B		4-2-31
0.25T110		1N5272B	4-2-32
0.25T110A		1N5272B	4-2-32
0.25T5.6		1N5232B	4-2-31
0.25T5.6A		1N5232B	4-2-31
1.0KE100A		1N6297A	4-1-44
1.0KE100CA		1.5KE120CA	4-1-44
1.0KE10A		1N6273A	4-1-43
1.0KE10CA		1.5KE12CA	4-1-43
1.0KE110A		1N6298A	4-1-44
1.0KE110CA		1.5KE130CA	4-1-44
1.0KE11A		1N6274A	4-1-43
1.0KE11CA		1.5KE13CA	4-1-43
1.0KE120A		1N6299A	4-1-44
1.0KE120CA		1.5KE150CA	4-1-44
1.0KE12A		1N6275A	4-1-43
1.0KE12CA		1.5KE15CA	4-1-43
1.0KE130A		1N6300A	4-1-44
1.0KE130CA		1.5KE160CA	4-1-44
1.0KE13A		1N6275A	4-1-43
1.0KE13CA		1.5KE15CA	4-1-43
1.0KE14A		1N6277A	4-1-43
1.0KE14CA		1.5KE18CA	4-1-43
1.0KE150A		1N6302A	4-1-44
1.0KE150CA		1.5KE180CA	4-1-44
1.0KE15A		1N6277A	4-1-43
1.0KE15CA		1.5KE18CA	4-1-43
1.0KE160A		1N6303A	4-1-44

Industry Part Number	Motorola Direct Replacement	Motorola Similar Replacement	Page Number
1.0KE160CA		1.5KE200CA	4-1-44
1.0KE16A		1N6278A	4-1-43
1.0KE16CA		1.5KE20CA	4-1-43
1.0KE170A		1N6303A	4-1-44
1.0KE170CA		1.5KE200CA	4-1-44
1.0KE17A		1N6278A	4-1-43
1.0KE17CA		1.5KE20CA	4-1-43
1.0KE18A		1N6279A	4-1-43
1.0KE18CA		1.5KE22CA	4-1-43
1.0KE20A		1N6280A	4-1-43
1.0KE20CA		1.5KE24CA	4-1-43
1.0KE22A		1N6281A	4-1-43
1.0KE22CA		1.5KE27CA	4-1-43
1.0KE24A		1N6282A	4-1-43
1.0KE24CA		1.5KE30CA	4-1-43
1.0KE26A		1N6283A	4-1-43
1.0KE26CA		1.5KE33CA	4-1-43
1.0KE28A		1N6283A	4-1-43
1.0KE28CA		1.5KE33CA	4-1-43
1.0KE30A		1N6284A	4-1-43
1.0KE30CA		1.5KE36CA	4-1-43
1.0KE33A		1N6285A	4-1-43
1.0KE33CA		1.5KE39CA	4-1-43
1.0KE36A		1N6286A	4-1-43
1.0KE36CA		1.5KE43CA	4-1-43
1.0KE40A		1N6287A	4-1-43
1.0KE40CA		1.5KE47CA	4-1-43
1.0KE43A		1N6288A	4-1-43
1.0KE43CA		1.5KE51CA	4-1-43
1.0KE45A		1N6289A	4-1-44
1.0KE45CA		1.5KE56CA	4-1-44
1.0KE48A		1N6289A	4-1-44
1.0KE48CA		1.5KE56CA	4-1-44
1.0KE5.0A		1N6267A	4-1-43
1.0KE5.0CA		1.5KE6.8CA	4-1-43
1.0KE51A		1N6290A	4-1-44
1.0KE51CA		1.5KE62CA	4-1-44
1.0KE54A		1N6291A	4-1-44
1.0KE54CA		1.5KE68CA	4-1-44
1.0KE58A		1N6291A	4-1-44
1.0KE58CA		1.5KE68CA	4-1-44
1.0KE6.0A		1N6268A	4-1-43
1.0KE6.0CA		1.5KE7.5CA	4-1-43
1.0KE6.5A		1N6268A	4-1-43
1.0KE6.5CA		1.5KE7.5CA	4-1-43
1.0KE60A		1N6292A	4-1-44
1.0KE60CA		1.5KE75CA	4-1-44
1.0KE64A		1N6292A	4-1-44
1.0KE64CA		1.5KE75CA	4-1-44
1.0KE7.0A		1N6269A	4-1-43
1.0KE7.0CA		1.5KE8.2CA	4-1-43

CF = consult factory representative

CROSS-REFERENCE (continued)

Industry Part Number	Motorola Direct Replacement	Motorola Similar Replacement	Page Number
1.0KE7.5A		1N6270A	4-1-43
1.0KE7.5CA		1.5KE9.1CA	4-1-43
1.0KE70A		1N6293A	4-1-44
1.0KE70CA		1.5KE82CA	4-1-44
1.0KE75A		1N6294A	4-1-44
1.0KE75CA		1.5KE91CA	4-1-44
1.0KE78A		1N6294A	4-1-44
1.0KE78CA		1.5KE91CA	4-1-44
1.0KE8.0A		1N6271A	4-1-43
1.0KE8.0CA		1.5KE10CA	4-1-43
1.0KE8.5A		1N6271A	4-1-43
1.0KE8.5CA		1.5KE10CA	4-1-43
1.0KE85A		1N6295A	4-1-44
1.0KE85CA		1.5KE100CA	4-1-44
1.0KE9.0A		1N6272A	4-1-43
1.0KE9.0CA		1.5KE11CA	4-1-43
1.0KE90A		1N6296A	4-1-44
1.0KE90CA		1.5KE110CA	4-1-44
1.2KE100A		1N6297A	4-1-44
1.2KE100CA		1.5KE120CA	4-1-44
1.2KE10A		1N6273A	4-1-43
1.2KE10CA		1.5KE12CA	4-1-43
1.2KE110A		1N6298A	4-1-44
1.2KE110CA		1.5KE130CA	4-1-44
1.2KE11A		1N6274A	4-1-43
1.2KE11CA		1.5KE13CA	4-1-43
1.2KE120A		1N6299A	4-1-44
1.2KE120CA		1.5KE150CA	4-1-44
1.2KE12A		1N6275A	4-1-43
1.2KE12CA		1.5KE15CA	4-1-43
1.2KE130A		1N6300A	4-1-44
1.2KE130CA		1.5KE160CA	4-1-44
1.2KE13A		1N6275A	4-1-43
1.2KE13CA		1.5KE15CA	4-1-43
1.2KE14A		1N6277A	4-1-43
1.2KE14CA		1.5KE18CA	4-1-43
1.2KE150A		1N6302A	4-1-44
1.2KE150CA		1.5KE180CA	4-1-44
1.2KE15A		1N6277A	4-1-43
1.2KE15CA		1.5KE18CA	4-1-43
1.2KE160A		1N6303A	4-1-44
1.2KE160CA		1.5KE200CA	4-1-44
1.2KE16A		1N6278A	4-1-43
1.2KE16CA		1.5KE20CA	4-1-43
1.2KE170A		1N6303A	4-1-44
1.2KE170CA		1.5KE200CA	4-1-44
1.2KE17A		1N6278A	4-1-43
1.2KE17CA		1.5KE20CA	4-1-43
1.2KE18A		1N6279A	4-1-43
1.2KE18CA		1.5KE22CA	4-1-43
1.2KE20A		1N6280A	4-1-43

Industry Part Number	Motorola Direct Replacement	Motorola Similar Replacement	Page Number
1.2KE20CA		1.5KE24CA	4-1-43
1.2KE22A		1N6281A	4-1-43
1.2KE22CA		1.5KE27CA	4-1-43
1.2KE24A		1N6282A	4-1-43
1.2KE24CA		1.5KE30CA	4-1-43
1.2KE26A		1N6283A	4-1-43
1.2KE26CA		1.5KE33CA	4-1-43
1.2KE28A		1N6283A	4-1-43
1.2KE28CA		1.5KE33CA	4-1-43
1.2KE30A		1N6284A	4-1-43
1.2KE30CA		1.5KE36CA	4-1-43
1.2KE33A		1N6285A	4-1-43
1.2KE33CA		1.5KE39CA	4-1-43
1.2KE36A		1N6286A	4-1-43
1.2KE36CA		1.5KE43CA	4-1-43
1.2KE40A		1N6287A	4-1-43
1.2KE40CA		1.5KE47CA	4-1-43
1.2KE43A		1N6288A	4-1-43
1.2KE43CA		1.5KE51CA	4-1-43
1.2KE45A		1N6289A	4-1-44
1.2KE45CA		1.5KE56CA	4-1-44
1.2KE48A		1N6289A	4-1-44
1.2KE48CA		1.5KE56CA	4-1-44
1.2KE5.0A		1N6267A	4-1-43
1.2KE5.0CA		1.5KE6.8CA	4-1-43
1.2KE51A		1N6290A	4-1-44
1.2KE51CA		1.5KE62CA	4-1-44
1.2KE54A		1N6291A	4-1-44
1.2KE54CA		1.5KE68CA	4-1-44
1.2KE58A		1N6291A	4-1-44
1.2KE58CA		1.5KE68CA	4-1-44
1.2KE6.0A		1N6268A	4-1-43
1.2KE6.0CA		1.5KE7.5CA	4-1-43
1.2KE6.5A		1N6268A	4-1-43
1.2KE6.5CA		1.5KE7.5CA	4-1-43
1.2KE60A		1N6292A	4-1-44
1.2KE60CA		1.5KE75CA	4-1-44
1.2KE64A		1N6292A	4-1-44
1.2KE64CA		1.5KE75CA	4-1-44
1.2KE7.0A		1N6269A	4-1-43
1.2KE7.0CA		1.5KE8.2CA	4-1-43
1.2KE7.5A		1N6270A	4-1-43
1.2KE7.5CA		1.5KE9.1CA	4-1-43
1.2KE70A		1N6293A	4-1-44
1.2KE70CA		1.5KE82CA	4-1-44
1.2KE75A		1N6294A	4-1-44
1.2KE75CA		1.5KE91CA	4-1-44
1.2KE78A		1N6294A	4-1-44
1.2KE78CA		1.5KE91CA	4-1-44
1.2KE8.0A		1N6271A	4-1-43
1.2KE8.0CA		1.5KE10CA	4-1-43

CF = consult factory representative



CROSS-REFERENCE (continued)

Industry Part Number	Motorola Direct Replacement	Motorola Similar Replacement	Page Number
1.2KE8.5A		1N6271A	4-1-43
1.2KE8.5CA		1.5KE10CA	4-1-43
1.2KE85A		1N6295A	4-1-44
1.2KE85CA		1.5KE100CA	4-1-44
1.2KE9.0A		1N6272A	4-1-43
1.2KE9.0CA		1.5KE11CA	4-1-43
1.2KE90A		1N6296A	4-1-44
1.2KE90CA		1.5KE110CA	4-1-44
1.5KE10	1.5KE10		4-1-43
1.5KE100	1.5KE100		4-1-44
1.5KE100A	1.5KE100A		4-1-44
1.5KE100C	1.5KE100C		4-1-44
1.5KE100CA	1.5KE100CA		4-1-44
1.5KE100CP		1.5KE100CA	4-1-44
1.5KE100P		1.5KE100A	4-1-44
1.5KE10A	1.5KE10A		4-1-43
1.5KE10C	1.5KE10C		4-1-43
1.5KE10CA	1.5KE10CA		4-1-43
1.5KE10CP		1.5KE10CA	4-1-43
1.5KE10P		1.5KE10A	4-1-43
1.5KE11	1.5KE11		4-1-43
1.5KE110	1.5KE110		4-1-44
1.5KE110A	1.5KE110A		4-1-44
1.5KE110C	1.5KE110C		4-1-44
1.5KE110CA	1.5KE110CA		4-1-44
1.5KE110CP		1.5KE110CA	4-1-44
1.5KE110P		1.5KE110A	4-1-44
1.5KE11A	1.5KE11A		4-1-43
1.5KE11C	1.5KE11C		4-1-43
1.5KE11CA	1.5KE11CA		4-1-43
1.5KE11CP		1.5KE11CA	4-1-43
1.5KE11P		1.5KE11A	4-1-43
1.5KE12	1.5KE12		4-1-43
1.5KE120	1.5KE120		4-1-44
1.5KE120A	1.5KE120A		4-1-44
1.5KE120C	1.5KE120C		4-1-44
1.5KE120CA	1.5KE120CA		4-1-44
1.5KE120CP		1.5KE120CA	4-1-44
1.5KE120P		1.5KE120A	4-1-44
1.5KE12A	1.5KE12A		4-1-43
1.5KE12C	1.5KE12C		4-1-43
1.5KE12CA	1.5KE12CA		4-1-43
1.5KE12CP		1.5KE12CA	4-1-43
1.5KE12P		1.5KE12A	4-1-43
1.5KE13	1.5KE13		4-1-43
1.5KE130	1.5KE130		4-1-44
1.5KE130A	1.5KE130A		4-1-44
1.5KE130C	1.5KE130C		4-1-44
1.5KE130CA	1.5KE130CA		4-1-44
1.5KE130CP		1.5KE130CA	4-1-44
1.5KE130P		1.5KE130A	4-1-44

Industry Part Number	Motorola Direct Replacement	Motorola Similar Replacement	Page Number
1.5KE13A	1.5KE13A		4-1-43
1.5KE13C	1.5KE13C		4-1-43
1.5KE13CA	1.5KE13CA		4-1-43
1.5KE13CP		1.5KE13CA	4-1-43
1.5KE13P		1.5KE13A	4-1-43
1.5KE15	1.5KE15		4-1-43
1.5KE150	1.5KE150		4-1-44
1.5KE150A	1.5KE150A		4-1-44
1.5KE150C	1.5KE150C		4-1-44
1.5KE150CA	1.5KE150CA		4-1-44
1.5KE150CP		1.5KE150CA	4-1-44
1.5KE150P		1.5KE150A	4-1-44
1.5KE15A	1.5KE15A		4-1-43
1.5KE15C	1.5KE15C		4-1-43
1.5KE15CA	1.5KE15CA		4-1-43
1.5KE15CP		1.5KE15CA	4-1-43
1.5KE15P		1.5KE15A	4-1-43
1.5KE16	1.5KE16		4-1-43
1.5KE160	1.5KE160		4-1-44
1.5KE160A	1.5KE160A		4-1-44
1.5KE160C	1.5KE160C		4-1-44
1.5KE160CA	1.5KE160CA		4-1-44
1.5KE160CP		1.5KE160CA	4-1-44
1.5KE160P		1.5KE160A	4-1-44
1.5KE16A	1.5KE16A		4-1-43
1.5KE16C	1.5KE16C		4-1-43
1.5KE16CA	1.5KE16CA		4-1-43
1.5KE16CP		1.5KE16CA	4-1-43
1.5KE16P		1.5KE16A	4-1-43
1.5KE170	1.5KE170		4-1-44
1.5KE170A	1.5KE170A		4-1-44
1.5KE170C	1.5KE170C		4-1-44
1.5KE170CA	1.5KE170CA		4-1-44
1.5KE170CP		1.5KE170CA	4-1-44
1.5KE170P		1.5KE170A	4-1-44
1.5KE18	1.5KE18		4-1-43
1.5KE180	1.5KE180		4-1-44
1.5KE180A	1.5KE180A		4-1-44
1.5KE180C	1.5KE180C		4-1-44
1.5KE180CA	1.5KE180CA		4-1-44
1.5KE180CP		1.5KE180CA	4-1-44
1.5KE180P		1.5KE180A	4-1-44
1.5KE18A	1.5KE18A		4-1-43
1.5KE18C	1.5KE18C		4-1-43
1.5KE18CA	1.5KE18CA		4-1-43
1.5KE18CP		1.5KE18CA	4-1-43
1.5KE18P		1.5KE18A	4-1-43
1.5KE20	1.5KE20		4-1-43
1.5KE200	1.5KE200		4-1-44
1.5KE200A	1.5KE200A		4-1-44
1.5KE200C	1.5KE200C		4-1-44

CF = consult factory representative

CROSS-REFERENCE (continued)

Industry Part Number	Motorola Direct Replacement	Motorola Similar Replacement	Page Number	Industry Part Number	Motorola Direct Replacement	Motorola Similar Replacement	Page Number
1.5KE200CA	1.5KE200CA		4-1-44	1.5KE36A	1.5KE36A		4-1-43
1.5KE200CP		1.5KE200CA	4-1-44	1.5KE36C	1.5KE36C		4-1-43
1.5KE200P		1.5KE200A	4-1-44	1.5KE36CA	1.5KE36CA		4-1-43
1.5KE20A	1.5KE20A		4-1-43	1.5KE36CP		1.5KE36CA	4-1-43
1.5KE20C	1.5KE20C		4-1-43	1.5KE36P		1.5KE36A	4-1-43
1.5KE20CA	1.5KE20CA		4-1-43	1.5KE39	1.5KE39		4-1-43
1.5KE20CP		1.5KE20CA	4-1-43	1.5KE39A	1.5KE39A		4-1-43
1.5KE20P		1.5KE20A	4-1-43	1.5KE39C	1.5KE39C		4-1-43
1.5KE22	1.5KE22		4-1-43	1.5KE39CA	1.5KE39CA		4-1-43
1.5KE220	1.5KE220		4-1-44	1.5KE39CP		1.5KE39CA	4-1-43
1.5KE220A	1.5KE220A		4-1-44	1.5KE39P		1.5KE39A	4-1-43
1.5KE220C	1.5KE220C		4-1-44	1.5KE43	1.5KE43		4-1-43
1.5KE220CA	1.5KE220CA		4-1-44	1.5KE43A	1.5KE43A		4-1-43
1.5KE220CP		1.5KE220CA	4-1-44	1.5KE43C	1.5KE43C		4-1-43
1.5KE220P		1.5KE220A	4-1-44	1.5KE43CA	1.5KE43CA		4-1-43
1.5KE22A	1.5KE22A		4-1-43	1.5KE43CP		1.5KE43CA	4-1-43
1.5KE22C	1.5KE22C		4-1-43	1.5KE43P		1.5KE43A	4-1-43
1.5KE22CA	1.5KE22CA		4-1-43	1.5KE47	1.5KE47		4-1-43
1.5KE22CP		1.5KE22CA	4-1-43	1.5KE47A	1.5KE47A		4-1-43
1.5KE22P		1.5KE22A	4-1-43	1.5KE47C	1.5KE47C		4-1-43
1.5KE24	1.5KE24		4-1-43	1.5KE47CA	1.5KE47CA		4-1-43
1.5KE24A	1.5KE24A		4-1-43	1.5KE47CP		1.5KE47CA	4-1-43
1.5KE24C	1.5KE24C		4-1-43	1.5KE47P		1.5KE47A	4-1-43
1.5KE24CA	1.5KE24CA		4-1-43	1.5KE51	1.5KE51		4-1-43
1.5KE24CP		1.5KE24CA	4-1-43	1.5KE51A	1.5KE51A		4-1-43
1.5KE24P		1.5KE24A	4-1-43	1.5KE51C	1.5KE51C		4-1-43
1.5KE250	1.5KE250		4-1-44	1.5KE51CA	1.5KE51CA		4-1-43
1.5KE250A	1.5KE250A		4-1-44	1.5KE51CP		1.5KE51CA	4-1-43
1.5KE250C	1.5KE250C		4-1-44	1.5KE51P		1.5KE51A	4-1-43
1.5KE250CA	1.5KE250CA		4-1-44	1.5KE56	1.5KE56		4-1-44
1.5KE250CP		1.5KE250CA	4-1-44	1.5KE56A	1.5KE56A		4-1-44
1.5KE250P		1.5KE250A	4-1-44	1.5KE56C	1.5KE56C		4-1-44
1.5KE27	1.5KE27		4-1-43	1.5KE56CA	1.5KE56CA		4-1-44
1.5KE27A	1.5KE27A		4-1-43	1.5KE56CP		1.5KE56CA	4-1-44
1.5KE27C	1.5KE27C		4-1-43	1.5KE56P		1.5KE56A	4-1-44
1.5KE27CA	1.5KE27CA		4-1-43	1.5KE6.8	1.5KE6.8		4-1-43
1.5KE27CP		1.5KE27CA	4-1-43	1.5KE6.8A	1.5KE6.8A		4-1-43
1.5KE27P		1.5KE27A	4-1-43	1.5KE6.8C	1.5KE6.8C		4-1-43
1.5KE30	1.5KE30		4-1-43	1.5KE6.8CA	1.5KE6.8CA		4-1-43
1.5KE30A	1.5KE30A		4-1-43	1.5KE62	1.5KE62		4-1-44
1.5KE30C	1.5KE30C		4-1-43	1.5KE62A	1.5KE62A		4-1-44
1.5KE30CA	1.5KE30CA		4-1-43	1.5KE62C	1.5KE62C		4-1-44
1.5KE30CP		1.5KE30CA	4-1-43	1.5KE62CA	1.5KE62CA		4-1-44
1.5KE30P		1.5KE30A	4-1-43	1.5KE62CP		1.5KE62CA	4-1-44
1.5KE33	1.5KE33		4-1-43	1.5KE62P		1.5KE62A	4-1-44
1.5KE33A	1.5KE33A		4-1-43	1.5KE68	1.5KE68		4-1-44
1.5KE33C	1.5KE33C		4-1-43	1.5KE68A	1.5KE68A		4-1-44
1.5KE33CA	1.5KE33CA		4-1-43	1.5KE68C	1.5KE68C		4-1-44
1.5KE33CP		1.5KE33CA	4-1-43	1.5KE68CA	1.5KE68CA		4-1-44
1.5KE33P		1.5KE33A	4-1-43	1.5KE68CP		1.5KE68CA	4-1-44
1.5KE36	1.5KE36		4-1-43	1.5KE68P		1.5KE68A	4-1-44

CF = consult factory representative



CROSS-REFERENCE (continued)

Industry Part Number	Motorola Direct Replacement	Motorola Similar Replacement	Page Number
1.5KE6V8A		1.5KE6.8A	4-1-43
1.5KE6V8CA		1.5KE6.8CA	4-1-43
1.5KE6V8CP		1.5KE6.8CA	4-1-43
1.5KE6V8P		1.5KE6.8A	4-1-43
1.5KE7.5	1.5KE7.5		4-1-43
1.5KE7.5A	1.5KE7.5A		4-1-43
1.5KE7.5C	1.5KE7.5C		4-1-43
1.5KE7.5CA	1.5KE7.5CA		4-1-43
1.5KE75	1.5KE75		4-1-44
1.5KE75A	1.5KE75A		4-1-44
1.5KE75C	1.5KE75C		4-1-44
1.5KE75CA	1.5KE75CA		4-1-44
1.5KE75CP		1.5KE75CA	4-1-44
1.5KE75P		1.5KE75A	4-1-44
1.5KE7V5A		1.5KE7.5A	4-1-43
1.5KE7V5CA		1.5KE7.5CA	4-1-43
1.5KE7V5CP		1.5KE7.5CA	4-1-43
1.5KE7V5P		1.5KE7.5A	4-1-43
1.5KE8.2	1.5KE8.2		4-1-43
1.5KE8.2A	1.5KE8.2A		4-1-43
1.5KE8.2C	1.5KE8.2C		4-1-43
1.5KE8.2CA	1.5KE8.2CA		4-1-43
1.5KE82	1.5KE82		4-1-44
1.5KE82A	1.5KE82A		4-1-44
1.5KE82C	1.5KE82C		4-1-44
1.5KE82CA	1.5KE82CA		4-1-44
1.5KE82CP		1.5KE82CA	4-1-44
1.5KE82P		1.5KE82A	4-1-44
1.5KE8V2A		1.5KE8.2A	4-1-43
1.5KE8V2CA		1.5KE8.2CA	4-1-43
1.5KE8V2CP		1.5KE8.2CA	4-1-43
1.5KE8V2P		1.5KE8.2A	4-1-43
1.5KE9.1	1.5KE9.1		4-1-43
1.5KE9.1A	1.5KE9.1A		4-1-43
1.5KE9.1C	1.5KE9.1C		4-1-43
1.5KE9.1CA	1.5KE9.1CA		4-1-43
1.5KE91	1.5KE91		4-1-44
1.5KE91A	1.5KE91A		4-1-44
1.5KE91C	1.5KE91C		4-1-44
1.5KE91CA	1.5KE91CA		4-1-44
1.5KE91CP		1.5KE91CA	4-1-44
1.5KE91P		1.5KE91A	4-1-44
1.5KE9V1A		1.5KE9.1A	4-1-43
1.5KE9V1CA		1.5KE9.1CA	4-1-43
1.5KE9V1CP		1.5KE9.1CA	4-1-43
1.5KE9V1P		1.5KE9.1A	4-1-43
1.5R200		1N5956A	4-2-52
1.5R200A		1N5956A	4-2-52
1.5R200B		1N5956B	4-2-52
1.5R6.8		1N5921A	4-2-51
1.5R6.8A		1N5921A	4-2-51

Industry Part Number	Motorola Direct Replacement	Motorola Similar Replacement	Page Number
1.5R6.8B		1N5921B	4-2-51
1.5SMC10AT3	1.5SMC10AT3		4-1-66
1.5SMC11AT3	1.5SMC11AT3		4-1-66
1.5SMC12AT3	1.5SMC12AT3		4-1-66
1.5SMC13AT3	1.5SMC13AT3		4-1-66
1.5SMC15AT3	1.5SMC15AT3		4-1-66
1.5SMC16AT3	1.5SMC16AT3		4-1-66
1.5SMC18AT3	1.5SMC18AT3		4-1-66
1.5SMC20AT3	1.5SMC20AT3		4-1-66
1.5SMC22AT3	1.5SMC22AT3		4-1-66
1.5SMC24AT3	1.5SMC24AT3		4-1-66
1.5SMC27AT3	1.5SMC27AT3		4-1-66
1.5SMC30AT3	1.5SMC30AT3		4-1-66
1.5SMC33AT3	1.5SMC33AT3		4-1-66
1.5SMC36AT3	1.5SMC36AT3		4-1-66
1.5SMC39AT3	1.5SMC39AT3		4-1-66
1.5SMC43AT3	1.5SMC43AT3		4-1-66
1.5SMC47AT3	1.5SMC47AT3		4-1-66
1.5SMC51AT3	1.5SMC51AT3		4-1-66
1.5SMC56AT3	1.5SMC56AT3		4-1-66
1.5SMC6.8AT3	1.5SMC6.8AT3		4-1-66
1.5SMC62AT3	1.5SMC62AT3		4-1-66
1.5SMC68AT3	1.5SMC68AT3		4-1-66
1.5SMC7.5AT3	1.5SMC7.5AT3		4-1-66
1.5SMC75AT3	1.5SMC75AT3		4-1-66
1.5SMC8.2AT3	1.5SMC8.2AT3		4-1-66
1.5SMC82AT3	1.5SMC82AT3		4-1-66
1.5SMC9.1AT3	1.5SMC9.1AT3		4-1-66
1.5SMC91AT3	1.5SMC91AT3		4-1-66
1/2R200		1N5281A	4-2-32
1/2R200A		1N5281A	4-2-32
1/2R200B		1N5281B	4-2-32
1/2R6.8		1N5235A	4-2-31
1/2R6.8A		1N5235A	4-2-31
1/2R6.8B		1N5235B	4-2-31
1/4LZ2.2D		1N5221A	4-2-31
1/4LZ2.2D10		1N5221A	4-2-31
1/4LZ2.2D5		1N5221B	4-2-31
1/4LZ6.8D		1N5235A	4-2-31
1/4LZ6.8D10		1N5235A	4-2-31
1/4LZ6.8D5		1N5235B	4-2-31
1/4M100Z10		1N5271B	4-2-32
1/4M100Z5		1N5271B	4-2-32
1/4M105Z10		1N5272B	4-2-32
1/4M105Z5		1N5272B	4-2-32
1/4M10Z10		1N5240B	4-2-31
1/4M10Z5		1N5240B	4-2-31
1/4M110Z10		1N5272B	4-2-32
1/4M110Z5		1N5272B	4-2-32
1/4M11Z10		1N5241B	4-2-31
1/4M11Z5		1N5241B	4-2-31

CF = consult factory representative

CROSS-REFERENCE (continued)

Industry Part Number	Motorola Direct Replacement	Motorola Similar Replacement	Page Number
1/4M120Z10		1N5273B	4-2-32
1/4M120Z5		1N5273B	4-2-32
1/4M12210		1N5242B	4-2-31
1/4M12Z5		1N5242B	4-2-31
1/4M130Z10		1N5274B	4-2-32
1/4M130Z5		1N5274B	4-2-32
1/4M13Z10		1N5243B	4-2-31
1/4M13Z5		1N5243B	4-2-31
1/4M140Z10		1N5275B	4-2-32
1/4M140Z5		1N5275B	4-2-32
1/4M14Z10		1N5244B	4-2-31
1/4M14Z5		1N5244B	4-2-31
1/4M150Z10		1N5276B	4-2-32
1/4M150Z5		1N5276B	4-2-32
1/4M15210		1N5245B	4-2-31
1/4M15Z5		1N5245B	4-2-31
1/4M16Z10		1N5246B	4-2-31
1/4M16Z5		1N5246B	4-2-31
1/4M175Z10		1N5279B	4-2-32
1/4M175Z5		1N5279B	4-2-32
1/4M17Z10		1N5247B	4-2-31
1/4M17Z5		1N5247B	4-2-31
1/4M18Z10		1N5248B	4-2-31
1/4M18Z5		1N5248B	4-2-31
1/4M19Z10		1N5249B	4-2-31
1/4M19Z5		1N5249B	4-2-31
1/4M2.4AZ10		1N5222B	4-2-31
1/4M2.4AZ5		1N5222B	4-2-31
1/4M2.7AZ10		1N5224B	4-2-31
1/4M2.7AZ5		1N5224B	4-2-31
1/4M200Z10		1N5281B	4-2-32
1/4M200Z5		1N5281B	4-2-32
1/4M20Z10		1N5250B	4-2-31
1/4M20Z5		1N5250B	4-2-31
1/4M22Z10		1N5251B	4-2-31
1/4M22Z5		1N5251B	4-2-31
1/4M24Z10		1N5252B	4-2-31
1/4M24Z5		1N5252B	4-2-31
1/4M25Z10		1N5253B	4-2-31
1/4M25Z5		1N5253B	4-2-31
1/4M27Z10		1N5254B	4-2-31
1/4M27Z5		1N5254B	4-2-31
1/4M3.0AZ10		1N5225B	4-2-31
1/4M3.0AZ5		1N5225B	4-2-31
1/4M3.3AZ10		1N5226B	4-2-31
1/4M3.3AZ5		1N5226B	4-2-31
1/4M3.6AZ10		1N5227B	4-2-31
1/4M3.6AZ5		1N5227B	4-2-31
1/4M3.9AZ10		1N5228B	4-2-31
1/4M3.9AZ5		1N5228B	4-2-31
1/4M30Z10		1N5256B	4-2-31

Industry Part Number	Motorola Direct Replacement	Motorola Similar Replacement	Page Number
1/4M30Z5		1N5256B	4-2-31
1/4M33Z10		1N5257B	4-2-31
1/4M33Z5		1N5257B	4-2-31
1/4M36Z10		1N5258B	4-2-31
1/4M36Z5		1N5258B	4-2-31
1/4M39Z10		1N5259B	4-2-31
1/4M39Z5		1N5259B	4-2-31
1/4M4.3AZ10		1N5229B	4-2-31
1/4M4.3AZ5		1N5229B	4-2-31
1/4M4.7AZ10		1N5230B	4-2-31
1/4M4.7AZ5		1N5230B	4-2-31
1/4M43Z10		1N5260B	4-2-31
1/4M43Z5		1N5260B	4-2-31
1/4M45Z10		1N5261B	4-2-31
1/4M45Z5		1N5261B	4-2-31
1/4M47Z10		1N5261B	4-2-31
1/4M47Z5		1N5261B	4-2-31
1/4M5.1AZ10		1N5231B	4-2-31
1/4M5.1AZ5		1N5231B	4-2-31
1/4M5.6AZ10		1N5232B	4-2-31
1/4M5.6AZ5		1N5232B	4-2-31
1/4M50Z10		1N5262B	4-2-31
1/4M50Z5		1N5262B	4-2-31
1/4M52Z10		1N5262B	4-2-31
1/4M52Z5		1N5262B	4-2-31
1/4M56Z10		1N5263B	4-2-31
1/4M56Z5		1N5263B	4-2-31
1/4M6.2AZ10		1N5234B	4-2-31
1/4M6.2AZ5		1N5234B	4-2-31
1/4M6.8Z10		1N5234B	4-2-31
1/4M6.8Z5		1N5234B	4-2-31
1/4M62Z10		1N5265B	4-2-31
1/4M62Z5		1N5265B	4-2-31
1/4M68Z10		1N5266B	4-2-32
1/4M68Z5		1N5266B	4-2-32
1/4M7.5Z10		1N5236B	4-2-31
1/4M7.5Z5		1N5236B	4-2-31
1/4M75Z10		1N5267B	4-2-32
1/4M75Z5		1N5267B	4-2-32
1/4M8.2Z10		1N5237B	4-2-31
1/4M8.2Z5		1N5237B	4-2-31
1/4M82Z10		1N5268B	4-2-32
1/4M82Z5		1N5268B	4-2-32
1/4M9.1Z10		1N5239B	4-2-31
1/4M9.1Z5		1N5239B	4-2-31
1/4M91Z10		1N5270B	4-2-32
1/4M91Z5		1N5270B	4-2-32
1/4Z110D		1N5272A	4-2-32
1/4Z110D10		1N5272A	4-2-32
1/4Z110D5		1N5272B	4-2-32
1/4Z6.8D		1N5235A	4-2-31

2

CF = consult factory representative

CROSS-REFERENCE (continued)

2

Industry Part Number	Motorola Direct Replacement	Motorola Similar Replacement	Page Number
1/4Z6.8D10		1N5235A	4-2-31
1/4Z6.8D5		1N5235B	4-2-31
1M110ZS10	1M110ZS10		4-2-56
1M110ZS5	1M110ZS5		4-2-56
1M120ZS10	1M120ZS10		4-2-56
1M120ZS5	1M120ZS5		4-2-56
1M130ZS10	1M130ZS10		4-2-56
1M130ZS5	1M130ZS5		4-2-56
1M150ZS10	1M150ZS10		4-2-56
1M150ZS5	1M150ZS5		4-2-56
1M160ZS10	1M160ZS10		4-2-56
1M160ZS5	1M160ZS5		4-2-56
1M180ZS10	1M180ZS10		4-2-56
1M180ZS5	1M180ZS5		4-2-56
1M200ZS10	1M200ZS10		4-2-56
1M200ZS5	1M200ZS5		4-2-56
1N1313		MZ4102	4-2-37
1N1313A		MZ4102	4-2-37
1N1314		1N4697	4-2-30
1N1314A		1N4697	4-2-30
1N1315		1N4700	4-2-30
1N1315A		1N4700	4-2-30
1N1316		1N4703	4-2-30
1N1316A		1N4703	4-2-30
1N1317		1N4706	4-2-30
1N1317A		1N4706	4-2-30
1N1318		1N4709	4-2-30
1N1318A		1N4709	4-2-30
1N1319		1N4712	4-2-30
1N1319A		1N4712	4-2-30
1N1320		1N4715	4-2-30
1N1320A		1N4715	4-2-30
1N1321		1N4717	4-2-30
1N1321A		1N4717	4-2-30
1N1425		1N4738A	4-2-44
1N1426		1N4742A	4-2-44
1N1427		1N4744A	4-2-44
1N1428		1N4746A	4-2-44
1N1429		1N4748A	4-2-44
1N1430		1N4750A	4-2-44
1N1431		1N4760A	4-2-44
1N1432		1N4764A	4-2-44
1N1484		1N4732A	4-2-44
1N1485		1N4735A	4-2-44
1N1507		1N4730	4-2-44
1N1507A		1N4730A	4-2-44
1N1508		1N4732	4-2-44
1N1508A		1N4732A	4-2-44
1N1509		1N4734	4-2-44
1N1509A		1N4734A	4-2-44
1N1510		1N4736	4-2-44

Industry Part Number	Motorola Direct Replacement	Motorola Similar Replacement	Page Number
1N1510A		1N4736A	4-2-44
1N1511		1N4738	4-2-44
1N1511A		1N4738A	4-2-44
1N1512		1N4740	4-2-44
1N1512A		1N4740A	4-2-44
1N1513		1N4742	4-2-44
1N1513A		1N4742A	4-2-44
1N1514		1N4744	4-2-44
1N1514A		1N4744A	4-2-44
1N1515		1N4746	4-2-44
1N1515A		1N4746A	4-2-44
1N1516		1N4748	4-2-44
1N1516A		1N4748A	4-2-44
1N1517		1N4750	4-2-44
1N1517A		1N4750A	4-2-44
1N1518		1N4730	4-2-44
1N1518A		1N4730A	4-2-44
1N1519		1N4732	4-2-44
1N1519A		1N4732A	4-2-44
1N1520		1N4734	4-2-44
1N1520A		1N4734A	4-2-44
1N1521		1N4736	4-2-44
1N1521A		1N4736A	4-2-44
1N1522		1N4738	4-2-44
1N1522A		1N4738A	4-2-44
1N1523		1N4740	4-2-44
1N1523A		1N4740A	4-2-44
1N1524		1N4742	4-2-44
1N1524A		1N4742A	4-2-44
1N1525		1N4744	4-2-44
1N1525A		1N4744A	4-2-44
1N1526		1N4746	4-2-44
1N1526A		1N4746A	4-2-44
1N1527		1N4748	4-2-44
1N1527A		1N4748A	4-2-44
1N1528		1N4750	4-2-44
1N1528A		1N4750A	4-2-44
1N1735		1N823	4-3-10
1N1744		1N4740	4-2-44
1N1765		1N4734	4-2-44
1N1765A		1N4734A	4-2-44
1N1766		1N4735	4-2-44
1N1766A		1N4735A	4-2-44
1N1767		1N4736	4-2-44
1N1767A		1N4736A	4-2-44
1N1768		1N4737	4-2-44
1N1768A		1N4737A	4-2-44
1N1769		1N4738	4-2-44
1N1769A		1N4738A	4-2-44
1N1770		1N4739	4-2-44
1N1770A		1N4739A	4-2-44

CF = consult factory representative

CROSS-REFERENCE (continued)

Industry Part Number	Motorola Direct Replacement	Motorola Similar Replacement	Page Number
1N1771		1N4740	4-2-44
1N1771A		1N4740A	4-2-44
1N1772		1N4741	4-2-44
1N1772A		1N4741A	4-2-44
1N1773		1N4742	4-2-44
1N1773A		1N4742A	4-2-44
1N1774		1N4743	4-2-44
1N1774A		1N4743A	4-2-44
1N1775		1N4744	4-2-44
1N1775A		1N4744A	4-2-44
1N1776		1N4745	4-2-44
1N1776A		1N4745A	4-2-44
1N1777		1N4746	4-2-44
1N1777A		1N4746A	4-2-44
1N1778		1N4747	4-2-44
1N1778A		1N4747A	4-2-44
1N1779		1N4748	4-2-44
1N1779A		1N4748A	4-2-44
1N1780		1N4749	4-2-44
1N1780A		1N4749A	4-2-44
1N1781		1N4750	4-2-44
1N1781A		1N4750A	4-2-44
1N1782		1N4751	4-2-44
1N1782A		1N4751A	4-2-44
1N1783		1N4752	4-2-44
1N1783A		1N4752A	4-2-44
1N1784		1N4753	4-2-44
1N1784A		1N4753A	4-2-44
1N1785		1N4754	4-2-44
1N1785A		1N4754A	4-2-44
1N1786		1N4755	4-2-44
1N1786A		1N4755A	4-2-44
1N1787		1N4756	4-2-44
1N1787A		1N4756A	4-2-44
1N1788		1N4757	4-2-44
1N1788A		1N4757A	4-2-44
1N1789		1N4758	4-2-44
1N1789A		1N4758A	4-2-44
1N1790		1N4759	4-2-44
1N1790A		1N4759A	4-2-44
1N1791		1N4760	4-2-44
1N1791A		1N4760A	4-2-44
1N1792		1N4761	4-2-44
1N1792A		1N4761A	4-2-44
1N1793		1N4762	4-2-44
1N1793A		1N4762A	4-2-44
1N1794		1N4763	4-2-44
1N1794A		1N4763A	4-2-44
1N1795		1N4764	4-2-44
1N1795A		1N4764A	4-2-44
1N1796		1M110ZS5	4-2-56

Industry Part Number	Motorola Direct Replacement	Motorola Similar Replacement	Page Number
1N1796A		1M110ZS5	4-2-56
1N1797		1M120ZS5	4-2-56
1N1797A		1M120ZS5	4-2-56
1N1798		1M130ZS5	4-2-56
1N1798A		1M130ZS5	4-2-56
1N1799		1M150ZS5	4-2-56
1N1799A		1M150ZS5	4-2-56
1N1800		1M160ZS5	4-2-56
1N1800A		1M160ZS5	4-2-56
1N1801		1M180ZS5	4-2-56
1N1801A		1M180ZS5	4-2-56
1N1802		1M200ZS5	4-2-56
1N1802A		1M200ZS5	4-2-56
1N1876		1N4740	4-2-44
1N1877		1N4742	4-2-44
1N1878		1N4744	4-2-44
1N1879		1N4746	4-2-44
1N1880		1N4748	4-2-44
1N1881		1N4750	4-2-44
1N1882		1N4752	4-2-44
1N1883		1N4754	4-2-44
1N1884		1N4756	4-2-44
1N1885		1N4758	4-2-44
1N1886		1N4760	4-2-44
1N1887		1N4762	4-2-44
1N1888		1N4764	4-2-44
1N1927		1N5228A	4-2-31
1N1928		1N5230A	4-2-31
1N1929		1N5232A	4-2-31
1N1930		1N5235A	4-2-31
1N1931		1N5237A	4-2-31
1N1932		1N5240A	4-2-31
1N1933		1N5242A	4-2-31
1N1934		1N5245A	4-2-31
1N1935		1N5248A	4-2-31
1N1936		1N5251A	4-2-31
1N1937		1N5254A	4-2-31
1N1938		1N5257A	4-2-31
1N1939		1N5259A	4-2-31
1N1940		1N5261A	4-2-31
1N1941		1N5263A	4-2-31
1N1942		1N5266A	4-2-32
1N1943		1N5268A	4-2-32
1N1944		1N5271A	4-2-32
1N1945		1N5273A	4-2-32
1N1946		1N5276A	4-2-32
1N1947		1N5279A	4-2-32
1N1954		1N5228A	4-2-31
1N1955		1N5230A	4-2-31
1N1956		1N5232A	4-2-31
1N1957		1N5235A	4-2-31



CF = consult factory representative

CROSS-REFERENCE (continued)

Industry Part Number	Motorola Direct Replacement	Motorola Similar Replacement	Page Number
1N1958		1N5237A	4-2-31
1N1959		1N5240A	4-2-31
1N1960		1N5242A	4-2-31
1N1961		1N5245A	4-2-31
1N1962		1N5248A	4-2-31
1N1963		1N5251A	4-2-31
1N1964		1N5254A	4-2-31
1N1965		1N5257A	4-2-31
1N1966		1N5259A	4-2-31
1N1967		1N5261A	4-2-31
1N1968		1N5263A	4-2-31
1N1969		1N5266A	4-2-32
1N1970		1N5268A	4-2-32
1N1971		1N5271A	4-2-32
1N1972		1N5273A	4-2-32
1N1973		1N5276A	4-2-32
1N1974		1N5279A	4-2-32
1N1981		1N5228A	4-2-31
1N1982		1N5230A	4-2-31
1N1983		1N5232A	4-2-31
1N1984		1N5235A	4-2-31
1N1985		1N5237A	4-2-31
1N1986		1N5240A	4-2-31
1N1987		1N5242A	4-2-31
1N1988		1N5245A	4-2-31
1N1989		1N5248A	4-2-31
1N1990		1N5251A	4-2-31
1N1991		1N5254A	4-2-31
1N1992		1N5257A	4-2-31
1N1993		1N5259A	4-2-31
1N1994		1N5261A	4-2-31
1N1995		1N5263A	4-2-31
1N1996		1N5266A	4-2-32
1N1997		1N5268A	4-2-32
1N1998		1N5271A	4-2-32
1N1999		1N5273A	4-2-32
1N2000		1N5276A	4-2-32
1N2001		1N5279A	4-2-32
1N2032		1N4733A	4-2-44
1N2032A		1N4733A	4-2-44
1N2033		1N4734A	4-2-44
1N2033A		1N4734A	4-2-44
1N2034		1N4736A	4-2-44
1N2034A		1N4736D	4-2-44
1N2035		1N4739A	4-2-44
1N2035A		1N4739D	4-2-44
1N2036		1N4741A	4-2-44
1N2036A		1N4741D	4-2-44
1N2037		1N4743A	4-2-44
1N2037A		1N4743D	4-2-44
1N2038		1N4745A	4-2-44

Industry Part Number	Motorola Direct Replacement	Motorola Similar Replacement	Page Number
1N2038A		1N4745D	4-2-44
1N2039		1N4747A	4-2-44
1N2039A		1N4747D	4-2-44
1N2040		1N4749A	4-2-44
1N2040A		1N4749C	4-2-44
1N2387		1N4751	4-2-44
1N2765		1N823A	4-3-10
1N2765A		1N825A	4-3-10
1N3016		MZP4736	4-2-56
1N3016A		MZP4736	4-2-56
1N3016B		MZP4736A	4-2-56
1N3017		MZP4737	4-2-56
1N3017A		MZP4737	4-2-56
1N3017B		MZP4737A	4-2-56
1N3018		MZP4738	4-2-56
1N3018A		MZP4738	4-2-56
1N3018B		MZP4738A	4-2-56
1N3019		MZP4739	4-2-56
1N3019A		MZP4739	4-2-56
1N3019B		MZP4739A	4-2-56
1N3020		MZP4740	4-2-56
1N3020A		MZP4740	4-2-56
1N3020B		MZP4740A	4-2-56
1N3021		MZP4741	4-2-56
1N3021A		MZP4741	4-2-56
1N3021B		MZP4741A	4-2-56
1N3022		MZP4742	4-2-56
1N3022A		MZP4742	4-2-56
1N3022B		MZP4742A	4-2-56
1N3023		MZP4743	4-2-56
1N3023A		MZP4743	4-2-56
1N3023B		MZP4743A	4-2-56
1N3024		MZP4744	4-2-56
1N3024A		MZP4744	4-2-56
1N3024B		MZP4744A	4-2-56
1N3025		MZP4745	4-2-56
1N3025A		MZP4745	4-2-56
1N3025B		MZP4745A	4-2-56
1N3026		MZP4746	4-2-56
1N3026A		MZP4746	4-2-56
1N3026B		MZP4746A	4-2-56
1N3027		MZP4747	4-2-56
1N3027A		MZP4747	4-2-56
1N3027B		MZP4747A	4-2-56
1N3028		MZP4748	4-2-56
1N3028A		MZP4748	4-2-56
1N3028B		MZP4748A	4-2-56
1N3029		MZP4749	4-2-56
1N3029A		MZP4749	4-2-56
1N3029B		MZP4749A	4-2-56
1N3030		MZP4750	4-2-56

CF = consult factory representative

CROSS-REFERENCE (continued)

Industry Part Number	Motorola Direct Replacement	Motorola Similar Replacement	Page Number
1N3030A		MZP4750	4-2-56
1N3030B		MZP4750A	4-2-56
1N3031		MZP4751	4-2-56
1N3031A		MZP4751	4-2-56
1N3031B		MZP4751A	4-2-56
1N3032		MZP4752	4-2-56
1N3032A		MZP4752	4-2-56
1N3032B		MZP4752A	4-2-56
1N3033		MZP4753	4-2-56
1N3033A		MZP4753	4-2-56
1N3033B		MZP4753A	4-2-56
1N3034		MZP4754	4-2-56
1N3034A		MZP4754	4-2-56
1N3034B		MZP4754A	4-2-56
1N3035		MZP4755	4-2-56
1N3035A		MZP4755	4-2-56
1N3035B		MZP4755A	4-2-56
1N3036		MZP4756	4-2-56
1N3036A		MZP4756	4-2-56
1N3036B		MZP4756A	4-2-56
1N3037		MZP4757	4-2-56
1N3037A		MZP4757	4-2-56
1N3037B		MZP4757A	4-2-56
1N3038		MZP4758	4-2-56
1N3038A		MZP4758	4-2-56
1N3038B		MZP4758A	4-2-56
1N3039		MZP4759	4-2-56
1N3039A		MZP4759	4-2-56
1N3039B		MZP4759A	4-2-56
1N3040		MZP4760	4-2-56
1N3040A		MZP4760	4-2-56
1N3040B		MZP4760A	4-2-56
1N3041		MZP4761	4-2-56
1N3041A		MZP4761	4-2-56
1N3041B		MZP4761A	4-2-56
1N3042		MZP4762	4-2-56
1N3042A		MZP4762	4-2-56
1N3042B		MZP4762A	4-2-56
1N3043		MZP4763	4-2-56
1N3043A		MZP4763	4-2-56
1N3043B		MZP4763A	4-2-56
1N3044		MZP4764	4-2-56
1N3044A		MZP4764	4-2-56
1N3044B		MZP4764A	4-2-56
1N3045		1M110ZS10	4-2-56
1N3045A		1M110ZS10	4-2-56
1N3045B		1M110ZS5	4-2-56
1N3046		1M120ZS10	4-2-56
1N3046A		1M120ZS10	4-2-56
1N3046B		1M120ZS5	4-2-56
1N3047		1M130ZS10	4-2-56

Industry Part Number	Motorola Direct Replacement	Motorola Similar Replacement	Page Number
1N3047A		1M130ZS10	4-2-56
1N3047B		1M130ZS5	4-2-56
1N3048		1M150ZS10	4-2-56
1N3048A		1M150ZS10	4-2-56
1N3048B		1M150ZS5	4-2-56
1N3049		1M160ZS10	4-2-56
1N3049A		1M160ZS10	4-2-56
1N3049B		1M160ZS5	4-2-56
1N3050		1M180ZS10	4-2-56
1N3050A		1M180ZS10	4-2-56
1N3050B		1M180ZS5	4-2-56
1N3051		1M200ZS10	4-2-56
1N3051A		1M200ZS10	4-2-56
1N3051B		1M200ZS5	4-2-56
1N3098		1M120ZS10	4-2-56
1N3098A		1M120ZS10	4-2-56
1N3099		1M150ZS10	4-2-56
1N3099A		1M150ZS10	4-2-56
1N3100		1M180ZS10	4-2-56
1N3100A		1M180ZS10	4-2-56
1N3101		1M200ZS10	4-2-56
1N3101A		1M200ZS10	4-2-56
1N3112		1N4737A	4-2-44
1N3181		1N5237A	4-2-31
1N3198		1N5221B	4-2-31
1N3411		1N5234A	4-2-31
1N3412		1N5235A	4-2-31
1N3413		1N5236A	4-2-31
1N3414		1N5237A	4-2-31
1N3415		1N5240A	4-2-31
1N3416		1N5242A	4-2-31
1N3417		1N5245A	4-2-31
1N3418		1N5248A	4-2-31
1N3419		1N5251A	4-2-31
1N3420		1N5254A	4-2-31
1N3421		1N5256A	4-2-31
1N3422		1N5257A	4-2-31
1N3423		1N5259A	4-2-31
1N3424		1N5261A	4-2-31
1N3425		1N5263A	4-2-31
1N3426		1N5266A	4-2-32
1N3427		1N5268A	4-2-32
1N3428		1N5271A	4-2-32
1N3429		1N5273A	4-2-32
1N3430		1N5276A	4-2-32
1N3431		1N5279A	4-2-32
1N3432		1N5281A	4-2-32
1N3443		3EZ6.2D5	4-2-53
1N3444		3EZ6.8D5	4-2-53
1N3445		3EZ8.2D5	4-2-53
1N3446		3EZ10D5	4-2-53



CF = consult factory representative

CROSS-REFERENCE (continued)

2

Industry Part Number	Motorola Direct Replacement	Motorola Similar Replacement	Page Number
1N3447		3EZ12D5	4-2-53
1N3448		3EZ15D5	4-2-53
1N3449		3EZ18D5	4-2-53
1N3450		3EZ22D5	4-2-53
1N3451		3EZ27D5	4-2-53
1N3452		3EZ30D5	4-2-53
1N3453		3EZ33D5	4-2-53
1N3454		3EZ39D5	4-2-53
1N3455		3EZ47D5	4-2-53
1N3456		3EZ56D5	4-2-53
1N3457		3EZ68D5	4-2-53
1N3458		3EZ82D5	4-2-53
1N3459		3EZ100D5	4-2-53
1N3460		3EZ120D5	4-2-53
1N3461		3EZ150D5	4-2-53
1N3462		3EZ180D5	4-2-53
1N3463		3EZ220D5	4-2-54
1N3477		1N5985B	4-2-33
1N3477A		1N5985B	4-2-33
1N3496		1N823	4-3-10
1N3497		1N825	4-3-10
1N3498		1N827	4-3-10
1N3499		1N829	4-3-10
1N3500		1N821	4-3-10
1N3506		1N5226B	4-2-31
1N3507		1N5227B	4-2-31
1N3508		1N5228B	4-2-31
1N3509		1N5229B	4-2-31
1N3510		1N5230B	4-2-31
1N3511		1N5231B	4-2-31
1N3512		1N5232B	4-2-31
1N3513		1N5234B	4-2-31
1N3514		1N5235B	4-2-31
1N3515		1N5236B	4-2-31
1N3516		1N5237B	4-2-31
1N3517		1N5239B	4-2-31
1N3518		1N5240B	4-2-31
1N3519		1N5241B	4-2-31
1N3520		1N5242B	4-2-31
1N3521		1N5243B	4-2-31
1N3522		1N5245B	4-2-31
1N3523		1N5246B	4-2-31
1N3524		1N5248B	4-2-31
1N3525		1N5250B	4-2-31
1N3526		1N5251B	4-2-31
1N3527		1N5252B	4-2-31
1N3528		1N5254B	4-2-31
1N3529		1N5256B	4-2-31
1N3530		1N5257B	4-2-31
1N3531		1N5258B	4-2-31
1N3532		1N5259B	4-2-31

Industry Part Number	Motorola Direct Replacement	Motorola Similar Replacement	Page Number
1N3533		1N5260B	4-2-31
1N3534		1N5261B	4-2-31
1N3553		1N821	4-3-10
1N3675		1N4736A	4-2-44
1N3675A		1N4736A	4-2-44
1N3675B		1N4736A	4-2-44
1N3676		1N4737A	4-2-44
1N3676A		1N4737A	4-2-44
1N3676B		1N4737A	4-2-44
1N3677		1N4738A	4-2-44
1N3677A		1N4738A	4-2-44
1N3677B		1N4738A	4-2-44
1N3678		1N4739A	4-2-44
1N3678A		1N4739A	4-2-44
1N3678B		1N4739A	4-2-44
1N3679		1N4740A	4-2-44
1N3679A		1N4740A	4-2-44
1N3679B		1N4740A	4-2-44
1N3680		1N4741A	4-2-44
1N3680A		1N4741A	4-2-44
1N3680B		1N4741A	4-2-44
1N3681		1N4742A	4-2-44
1N3681A		1N4742A	4-2-44
1N3681B		1N4742A	4-2-44
1N3682		1N4743A	4-2-44
1N3682A		1N4743A	4-2-44
1N3682B		1N4743A	4-2-44
1N3683		1N4744A	4-2-44
1N3683A		1N4744A	4-2-44
1N3683B		1N4744A	4-2-44
1N3684		1N4745A	4-2-44
1N3684A		1N4745A	4-2-44
1N3684B		1N4745A	4-2-44
1N3685		1N4746A	4-2-44
1N3685A		1N4746A	4-2-44
1N3685B		1N4746A	4-2-44
1N3686		1N4747A	4-2-44
1N3686A		1N4747A	4-2-44
1N3686B		1N4747A	4-2-44
1N3687		1N4748A	4-2-44
1N3687A		1N4748A	4-2-44
1N3687B		1N4748A	4-2-44
1N3688		1N4749A	4-2-44
1N3688A		1N4749A	4-2-44
1N3688B		1N4749A	4-2-44
1N3689		1N4750A	4-2-44
1N3689A		1N4750A	4-2-44
1N3689B		1N4750A	4-2-44
1N3690		1N4751A	4-2-44
1N3690A		1N4751A	4-2-44
1N3690B		1N4751A	4-2-44

CF = consult factory representative

CROSS-REFERENCE (continued)

Industry Part Number	Motorola Direct Replacement	Motorola Similar Replacement	Page Number
1N3691		1N4752A	4-2-44
1N3691A		1N4752A	4-2-44
1N3691B		1N4752A	4-2-44
1N3692		1N4753A	4-2-44
1N3692A		1N4753A	4-2-44
1N3692B		1N4753A	4-2-44
1N3693		1N4754A	4-2-44
1N3693A		1N4754A	4-2-44
1N3693B		1N4754A	4-2-44
1N3694		1N4755A	4-2-44
1N3694A		1N4755A	4-2-44
1N3694B		1N4755A	4-2-44
1N3695		1N4756A	4-2-44
1N3695A		1N4756A	4-2-44
1N3695B		1N4756A	4-2-44
1N3696		1N4757A	4-2-44
1N3696A		1N4757A	4-2-44
1N3696B		1N4757A	4-2-44
1N3697		1N4758A	4-2-44
1N3697A		1N4758A	4-2-44
1N3697B		1N4758A	4-2-44
1N3698		1N4759A	4-2-44
1N3698A		1N4759A	4-2-44
1N3698B		1N4759A	4-2-44
1N3699		1N4760A	4-2-44
1N3699A		1N4760A	4-2-44
1N3699B		1N4760A	4-2-44
1N370		1N5221B	4-2-31
1N3700		1N4761A	4-2-44
1N3700A		1N4761A	4-2-44
1N3700B		1N4761A	4-2-44
1N3701		1N4762A	4-2-44
1N3701A		1N4762A	4-2-44
1N3701B		1N4762A	4-2-44
1N3702		1N4763A	4-2-44
1N3702A		1N4763A	4-2-44
1N3702B		1N4763A	4-2-44
1N3703		1N4764A	4-2-44
1N3703A		1N4764A	4-2-44
1N3703B		1N4764A	4-2-44
1N3704		1M110ZS10	4-2-56
1N3704A		1M110ZS10	4-2-56
1N3704B		1M110ZS5	4-2-56
1N3705		1M120ZS10	4-2-56
1N3705A		1M120ZS10	4-2-56
1N3705B		1M120ZS5	4-2-56
1N3706		1M130ZS10	4-2-56
1N3706A		1M130ZS10	4-2-56
1N3706B		1M130ZS5	4-2-56
1N3707		1M150ZS10	4-2-56
1N3707A		1M150ZS10	4-2-56

Industry Part Number	Motorola Direct Replacement	Motorola Similar Replacement	Page Number
1N3707B		1M150ZS5	4-2-56
1N3708		1M160ZS10	4-2-56
1N3708A		1M160ZS10	4-2-56
1N3708B		1M160ZS5	4-2-56
1N3709		1M180ZS10	4-2-56
1N3709A		1M180ZS10	4-2-56
1N3709B		1M180ZS5	4-2-56
1N371		1N5221A	4-2-31
1N3710		1M200ZS10	4-2-56
1N3710A		1M200ZS10	4-2-56
1N3710B		1M200ZS5	4-2-56
1N372		1N5225A	4-2-31
1N373		1N5227A	4-2-31
1N374		1N5229A	4-2-31
1N375		1N5230A	4-2-31
1N376		1N5233A	4-2-31
1N377		1N5236A	4-2-31
1N3779		1N821A	4-3-10
1N378		1N5238A	4-2-31
1N3780		1N821A	4-3-10
1N3781		1N823A	4-3-10
1N3782		1N825A	4-3-10
1N3783		1N827A	4-3-10
1N3784		1N829A	4-3-10
1N3785		1N5921A	4-2-51
1N3785A		1N5921A	4-2-51
1N3785B		1N5921B	4-2-51
1N3786		1N5922A	4-2-51
1N3786A		1N5922A	4-2-51
1N3786B		1N5922B	4-2-51
1N3787		1N5923A	4-2-51
1N3787A		1N5923A	4-2-51
1N3787B		1N5923B	4-2-51
1N3788		1N5924A	4-2-51
1N3788A		1N5924A	4-2-51
1N3788B		1N5924B	4-2-51
1N3789		1N5925A	4-2-51
1N3789A		1N5925A	4-2-51
1N3789B		1N5925B	4-2-51
1N379		1N5240A	4-2-31
1N3790		1N5926A	4-2-51
1N3790A		1N5926A	4-2-51
1N3790B		1N5926B	4-2-51
1N3791		1N5927A	4-2-51
1N3791A		1N5927A	4-2-51
1N3791B		1N5927B	4-2-51
1N3792		1N5928A	4-2-51
1N3792A		1N5928A	4-2-51
1N3792B		1N5928B	4-2-51
1N3793		1N5929A	4-2-51
1N3793A		1N5929A	4-2-51



CF = consult factory representative

CROSS-REFERENCE (continued)

2

Industry Part Number	Motorola Direct Replacement	Motorola Similar Replacement	Page Number
1N3793B		1N5929B	4-2-51
1N3794		1N5930A	4-2-51
1N3794A		1N5930A	4-2-51
1N3794B		1N5930B	4-2-51
1N3795		1N5931A	4-2-51
1N3795A		1N5931A	4-2-51
1N3795B		1N5931B	4-2-51
1N3796		1N5932A	4-2-51
1N3796A		1N5932A	4-2-51
1N3796B		1N5932B	4-2-51
1N3797		1N5933A	4-2-51
1N3797A		1N5933A	4-2-51
1N3797B		1N5933B	4-2-51
1N3798		1N5934A	4-2-51
1N3798A		1N5934A	4-2-51
1N3798B		1N5934B	4-2-51
1N3799		1N5935A	4-2-51
1N3799A		1N5935A	4-2-51
1N3799B		1N5935B	4-2-51
1N380		1N5243A	4-2-31
1N3800		1N5936A	4-2-51
1N3800A		1N5936A	4-2-51
1N3800B		1N5936B	4-2-51
1N3801		1N5937A	4-2-51
1N3801A		1N5937A	4-2-51
1N3801B		1N5937B	4-2-51
1N3802		1N5938A	4-2-51
1N3802A		1N5938A	4-2-51
1N3802B		1N5938B	4-2-51
1N3803		1N5939A	4-2-51
1N3803A		1N5939A	4-2-51
1N3803B		1N5939B	4-2-51
1N3804		1N5940A	4-2-51
1N3804A		1N5940A	4-2-51
1N3804B		1N5940B	4-2-51
1N3805		1N5941A	4-2-51
1N3805A		1N5941A	4-2-51
1N3805B		1N5941B	4-2-51
1N3806		1N5942A	4-2-51
1N3806A		1N5942A	4-2-51
1N3806B		1N5942B	4-2-51
1N3807		1N5943A	4-2-51
1N3807A		1N5943A	4-2-51
1N3807B		1N5943B	4-2-51
1N3808		1N5944A	4-2-51
1N3808A		1N5944A	4-2-51
1N3808B		1N5944B	4-2-51
1N3809		1N5945A	4-2-51
1N3809A		1N5945A	4-2-51
1N3809B		1N5945B	4-2-51
1N381		1N5246A	4-2-31

Industry Part Number	Motorola Direct Replacement	Motorola Similar Replacement	Page Number
1N3810		1N5946A	4-2-51
1N3810A		1N5946A	4-2-51
1N3810B		1N5946B	4-2-51
1N3811		1N5947A	4-2-51
1N3811A		1N5947A	4-2-51
1N3811B		1N5947B	4-2-51
1N3812		1N5948A	4-2-52
1N3812A		1N5948A	4-2-52
1N3812B		1N5948B	4-2-52
1N3813		1N5949A	4-2-52
1N3813A		1N5949A	4-2-52
1N3813B		1N5949B	4-2-52
1N3814		1N5950A	4-2-52
1N3814A		1N5950A	4-2-52
1N3814B		1N5950B	4-2-52
1N3815		1N5951A	4-2-52
1N3815A		1N5951A	4-2-52
1N3815B		1N5951B	4-2-52
1N3816		1N5952A	4-2-52
1N3816A		1N5952A	4-2-52
1N3816B		1N5952B	4-2-52
1N3817		1N5953A	4-2-52
1N3817A		1N5953A	4-2-52
1N3817B		1N5953B	4-2-52
1N3818		1N5954A	4-2-52
1N3818A		1N5954A	4-2-52
1N3818B		1N5954B	4-2-52
1N3819		1N5955A	4-2-52
1N3819A		1N5955A	4-2-52
1N3819B		1N5955B	4-2-52
1N382		1N5249A	4-2-31
1N3820		1N5956A	4-2-52
1N3820A		1N5956A	4-2-52
1N3820B		1N5956B	4-2-52
1N3821		MZP4728	4-2-56
1N3821A		MZP4728A	4-2-56
1N3822		MZP4729	4-2-56
1N3822A		MZP4729A	4-2-56
1N3823		MZP4730	4-2-56
1N3823A		MZP4730A	4-2-56
1N3824		MZP4731	4-2-56
1N3824A		MZP4731A	4-2-56
1N3825		MZP4732	4-2-56
1N3825A		MZP4732A	4-2-56
1N3826		MZP4733	4-2-56
1N3826A		MZP4733A	4-2-56
1N3827		MZP4734	4-2-56
1N3827A		MZP4734A	4-2-56
1N3828		MZP4735	4-2-56
1N3828A		MZP4735A	4-2-56
1N3829		MZP4736	4-2-56

CF = consult factory representative

CROSS-REFERENCE (continued)

Industry Part Number	Motorola Direct Replacement	Motorola Similar Replacement	Page Number	Industry Part Number	Motorola Direct Replacement	Motorola Similar Replacement	Page Number
1N3829A		MZP4736A	4-2-56	1N4029B		1N6282A	4-1-43
1N383		1N5252A	4-2-31	1N4030		1N6283	4-1-43
1N3830		MZP4737	4-2-56	1N4030A		1N6283	4-1-43
1N3830A		MZP4737A	4-2-56	1N4030B		1N6283A	4-1-43
1N384		1N5255A	4-2-31	1N4031		1N6284	4-1-43
1N385		1N5258A	4-2-31	1N4031A		1N6284	4-1-43
1N386		1N5260A	4-2-31	1N4031B		1N6284A	4-1-43
1N387		1N5261A	4-2-31	1N4032		1N6285	4-1-43
1N3951		1N5934B	4-2-51	1N4032A		1N6285	4-1-43
1N4010		1N821	4-3-10	1N4032B		1N6285A	4-1-43
1N4016		1N6269	4-1-43	1N4033		1N6286	4-1-43
1N4016A		1N6269	4-1-43	1N4033A		1N6286	4-1-43
1N4016B		1N6268A	4-1-43	1N4033B		1N6286A	4-1-43
1N4017		1N6270	4-1-43	1N4034		1N6287	4-1-43
1N4017A		1N6270	4-1-43	1N4034A		1N6287	4-1-43
1N4017B		1N6270A	4-1-43	1N4034B		1N6287A	4-1-43
1N4018		1N6271	4-1-43	1N4035		1N6288	4-1-43
1N4018A		1N6271	4-1-43	1N4035A		1N6288	4-1-43
1N4018B		1N6271A	4-1-43	1N4035B		1N6288A	4-1-43
1N4019		1N6272	4-1-43	1N4036		1N6289	4-1-44
1N4019A		1N6272	4-1-43	1N4036A		1N6289	4-1-44
1N4019B		1N6272A	4-1-43	1N4036B		1N6289A	4-1-44
1N4020		1N6273	4-1-43	1N4037		1N6290	4-1-44
1N4020A		1N6273	4-1-43	1N4037A		1N6290	4-1-44
1N4020B		1N6273A	4-1-43	1N4037B		1N6290A	4-1-44
1N4021		1N6274	4-1-43	1N4038		1N6291	4-1-44
1N4021A		1N6274	4-1-43	1N4038A		1N6291	4-1-44
1N4021B		1N6274A	4-1-43	1N4038B		1N6291A	4-1-44
1N4022		1N6275	4-1-43	1N4039		1N6292	4-1-44
1N4022A		1N6275	4-1-43	1N4039A		1N6292	4-1-44
1N4022B		1N6275A	4-1-43	1N4039B		1N6292A	4-1-44
1N4023		1N6276	4-1-43	1N4040		1N6293	4-1-44
1N4023A		1N6276	4-1-43	1N4040A		1N6293	4-1-44
1N4023B		1N6276A	4-1-43	1N4040B		1N6293A	4-1-44
1N4024		1N6277	4-1-43	1N4041		1N6294	4-1-44
1N4024A		1N6277	4-1-43	1N4041A		1N6294	4-1-44
1N4024B		1N6277A	4-1-43	1N4041B		1N6294A	4-1-44
1N4025		1N6278	4-1-43	1N4042		1N6295	4-1-44
1N4025A		1N6278	4-1-43	1N4042A		1N6295	4-1-44
1N4025B		1N6278A	4-1-43	1N4042B		1N6295A	4-1-44
1N4026		1N6279	4-1-43	1N4095		1N5993B	4-2-33
1N4026A		1N6279	4-1-43	1N4096		3EZ91D5	4-2-53
1N4026B		1N6279A	4-1-43	1N4097		3EZ100D5	4-2-53
1N4027		1N6280	4-1-43	1N4098		3EZ150D5	4-2-53
1N4027A		1N6280	4-1-43	1N4099		MZ4099	4-2-37
1N4027B		1N6280A	4-1-43	1N4100		MZ4100	4-2-37
1N4028		1N6281	4-1-43	1N4101		MZ4101	4-2-37
1N4028A		1N6281	4-1-43	1N4102		MZ4102	4-2-37
1N4028B		1N6281A	4-1-43	1N4103		MZ4103	4-2-37
1N4029		1N6282	4-1-43	1N4104		MZ4104	4-2-37
1N4029A		1N6282	4-1-43	1N4105		1N4698	4-2-30

CF = consult factory representative



CROSS-REFERENCE (continued)

2

Industry Part Number	Motorola Direct Replacement	Motorola Similar Replacement	Page Number
1N4106		1N4699	4-2-30
1N4107		1N4700	4-2-30
1N4108		1N4701	4-2-30
1N4109		1N4702	4-2-30
1N4110		1N4703	4-2-30
1N4111		1N4704	4-2-30
1N4112		1N4705	4-2-30
1N4113		1N4706	4-2-30
1N4114		1N4707	4-2-30
1N4115		1N4708	4-2-30
1N4116		1N4709	4-2-30
1N4117		1N4710	4-2-30
1N4118		1N4711	4-2-30
1N4119		1N4712	4-2-30
1N4120		1N4713	4-2-30
1N4121		1N4714	4-2-30
1N4122		1N4715	4-2-30
1N4123		1N4716	4-2-30
1N4124		1N4717	4-2-30
1N4125		1N5261B	4-2-31
1N4126		1N5262B	4-2-31
1N4127		1N5263B	4-2-31
1N4128		1N5264B	4-2-31
1N4129		1N5265B	4-2-31
1N4130		1N5266B	4-2-32
1N4131		1N5267B	4-2-32
1N4132		1N5268B	4-2-32
1N4133		1N5269B	4-2-32
1N4134		1N5270B	4-2-32
1N4135		1N5271B	4-2-32
1N4158		1N4736	4-2-44
1N4158A		1N4736	4-2-44
1N4158B		1N4736A	4-2-44
1N4159		1N4737	4-2-44
1N4159A		1N4737	4-2-44
1N4159B		1N4737A	4-2-44
1N4160		1N4738	4-2-44
1N4160A		1N4738	4-2-44
1N4160B		1N4738A	4-2-44
1N4161		1N4739	4-2-44
1N4161A		1N4739	4-2-44
1N4161B		1N4739A	4-2-44
1N4162		1N4740	4-2-44
1N4162A		1N4740	4-2-44
1N4162B		1N4740A	4-2-44
1N4163		1N4741	4-2-44
1N4163A		1N4741	4-2-44
1N4163B		1N4741A	4-2-44
1N4164		1N4742	4-2-44
1N4164A		1N4742	4-2-44
1N4164B		1N4742A	4-2-44

Industry Part Number	Motorola Direct Replacement	Motorola Similar Replacement	Page Number
1N4165		1N4743	4-2-44
1N4165A		1N4743	4-2-44
1N4165B		1N4743A	4-2-44
1N4166		1N4744	4-2-44
1N4166A		1N4744	4-2-44
1N4166B		1N4744A	4-2-44
1N4167		1N4745	4-2-44
1N4167A		1N4745	4-2-44
1N4167B		1N4745A	4-2-44
1N4168		1N4746	4-2-44
1N4168A		1N4746	4-2-44
1N4168B		1N4746A	4-2-44
1N4169		1N4747	4-2-44
1N4169A		1N4747	4-2-44
1N4169B		1N4747A	4-2-44
1N4170		1N4748	4-2-44
1N4170A		1N4748	4-2-44
1N4170B		1N4748A	4-2-44
1N4171		1N4749	4-2-44
1N4171A		1N4749	4-2-44
1N4171B		1N4749A	4-2-44
1N4172		1N4750	4-2-44
1N4172A		1N4750	4-2-44
1N4172B		1N4750A	4-2-44
1N4173		1N4751	4-2-44
1N4173A		1N4751	4-2-44
1N4173B		1N4751A	4-2-44
1N4174		1N4752	4-2-44
1N4174A		1N4752	4-2-44
1N4174B		1N4752A	4-2-44
1N4175		1N4753	4-2-44
1N4175A		1N4753	4-2-44
1N4175B		1N4753A	4-2-44
1N4176		1N4754	4-2-44
1N4176A		1N4754	4-2-44
1N4176B		1N4754A	4-2-44
1N4177		1N4755	4-2-44
1N4177A		1N4755	4-2-44
1N4177B		1N4755A	4-2-44
1N4178		1N4756	4-2-44
1N4178A		1N4756	4-2-44
1N4178B		1N4756A	4-2-44
1N4179		1N4757	4-2-44
1N4179A		1N4757	4-2-44
1N4179B		1N4757A	4-2-44
1N4180		1N4758	4-2-44
1N4180A		1N4758	4-2-44
1N4180B		1N4758A	4-2-44
1N4181		1N4759	4-2-44
1N4181A		1N4759	4-2-44
1N4181B		1N4759A	4-2-44

CF = consult factory representative

CROSS-REFERENCE (continued)

Industry Part Number	Motorola Direct Replacement	Motorola Similar Replacement	Page Number	Industry Part Number	Motorola Direct Replacement	Motorola Similar Replacement	Page Number
1N4182		1N4760	4-2-44	1N4327B		1N4740A	4-2-44
1N4182A		1N4760	4-2-44	1N4328		1N4741	4-2-44
1N4182B		1N4760A	4-2-44	1N4328A		1N4741A	4-2-44
1N4183		1N4761	4-2-44	1N4328B		1N4741A	4-2-44
1N4183A		1N4761	4-2-44	1N4329		1N4742	4-2-44
1N4183B		1N4761A	4-2-44	1N4329A		1N4742	4-2-44
1N4184		1N4762	4-2-44	1N4329B		1N4742A	4-2-44
1N4184A		1N4762	4-2-44	1N4330		1N4743	4-2-44
1N4184B		1N4762A	4-2-44	1N4330A		1N4743	4-2-44
1N4185		1N4763	4-2-44	1N4330B		1N4743A	4-2-44
1N4185A		1N4763	4-2-44	1N4331		1N4744	4-2-44
1N4185B		1N4763A	4-2-44	1N4331A		1N4744	4-2-44
1N4186		1N4764	4-2-44	1N4331B		1N4744A	4-2-44
1N4186A		1N4764	4-2-44	1N4332		1N4745	4-2-44
1N4186B		1N4764A	4-2-44	1N4332A		1N4745	4-2-44
1N4187		1M110ZS10	4-2-56	1N4332B		1N4745A	4-2-44
1N4187A		1M110ZS10	4-2-56	1N4333		1N4746	4-2-44
1N4187B		1M110ZS5	4-2-56	1N4333A		1N4746	4-2-44
1N4188		1M120ZS10	4-2-56	1N4333B		1N4746A	4-2-44
1N4188A		1M120ZS10	4-2-56	1N4334		1N4747	4-2-44
1N4188B		1M120ZS5	4-2-56	1N4334A		1N4747	4-2-44
1N4189		1M130ZS10	4-2-56	1N4334B		1N4747A	4-2-44
1N4189A		1M130ZS10	4-2-56	1N4335		1N4748	4-2-44
1N4189B		1M130ZS5	4-2-56	1N4335A		1N4748	4-2-44
1N4190		1M150ZS10	4-2-56	1N4335B		1N4748A	4-2-44
1N4190A		1M150ZS10	4-2-56	1N4336		1N4749	4-2-44
1N4190B		1M150ZS5	4-2-56	1N4336A		1N4749	4-2-44
1N4191		1M160ZS10	4-2-56	1N4336B		1N4749A	4-2-44
1N4191A		1M160ZS10	4-2-56	1N4337		1N4750	4-2-44
1N4191B		1M160ZS5	4-2-56	1N4337A		1N4750	4-2-44
1N4192		1M180ZS10	4-2-56	1N4337B		1N4750A	4-2-44
1N4192A		1M180ZS10	4-2-56	1N4338		1N4751	4-2-44
1N4192B		1M180ZS5	4-2-56	1N4338A		1N4751	4-2-44
1N4193		1M200ZS10	4-2-56	1N4338B		1N4751A	4-2-44
1N4193A		1M200ZS10	4-2-56	1N4339		1N4752	4-2-44
1N4193B		1M200ZS5	4-2-56	1N4339A		1N4752	4-2-44
1N4321		3EZ51D5	4-2-53	1N4339B		1N4752A	4-2-44
1N4323		1N4736	4-2-44	1N4340		1N4753	4-2-44
1N4323A		1N4736	4-2-44	1N4340A		1N4753	4-2-44
1N4323B		1N4736A	4-2-44	1N4340B		1N4753A	4-2-44
1N4324		1N4737	4-2-44	1N4341		1N4754	4-2-44
1N4324A		1N4737	4-2-44	1N4341A		1N4754	4-2-44
1N4324B		1N4737A	4-2-44	1N4341B		1N4754A	4-2-44
1N4325		1N4738	4-2-44	1N4342		1N4755	4-2-44
1N4325A		1N4738	4-2-44	1N4342A		1N4755	4-2-44
1N4325B		1N4738A	4-2-44	1N4342B		1N4755A	4-2-44
1N4326		1N4739	4-2-44	1N4343		1N4756	4-2-44
1N4326A		1N4739	4-2-44	1N4343A		1N4756	4-2-44
1N4326B		1N4739A	4-2-44	1N4343B		1N4756A	4-2-44
1N4327		1N4740	4-2-44	1N4344		1N4757	4-2-44
1N4327A		1N4740	4-2-44	1N4344A		1N4757	4-2-44

CF = consult factory representative



CROSS-REFERENCE (continued)

Industry Part Number	Motorola Direct Replacement	Motorola Similar Replacement	Page Number
1N4344B		1N4757A	4-2-44
1N4345		1N4758	4-2-44
1N4345A		1N4758	4-2-44
1N4345B		1N4758A	4-2-44
1N4346		1N4759	4-2-44
1N4346A		1N4759	4-2-44
1N4346B		1N4759A	4-2-44
1N4347		1N4760	4-2-44
1N4347A		1N4760	4-2-44
1N4347B		1N4760A	4-2-44
1N4348		1N4761	4-2-44
1N4348A		1N4761	4-2-44
1N4348B		1N4761A	4-2-44
1N4349		1N4762	4-2-44
1N4349A		1N4762	4-2-44
1N4349B		1N4762A	4-2-44
1N4350		1N4763	4-2-44
1N4350A		1N4763	4-2-44
1N4350B		1N4763A	4-2-44
1N4351		1N4764	4-2-44
1N4351A		1N4764	4-2-44
1N4351B		1N4764A	4-2-44
1N4352		1M110ZS10	4-2-56
1N4352A		1M110ZS10	4-2-56
1N4352B		1M110ZS5	4-2-56
1N4353		1M120ZS10	4-2-56
1N4353A		1M120ZS10	4-2-56
1N4353B		1M120ZS5	4-2-56
1N4354		1M130ZS10	4-2-56
1N4354A		1M130ZS10	4-2-56
1N4354B		1M130ZS5	4-2-56
1N4355		1M150ZS10	4-2-56
1N4355A		1M150ZS10	4-2-56
1N4355B		1M150ZS5	4-2-56
1N4356		1M160ZS10	4-2-56
1N4356A		1M160ZS10	4-2-56
1N4356B		1M160ZS5	4-2-56
1N4357		1M180ZS10	4-2-56
1N4357A		1M180ZS10	4-2-56
1N4357B		1M180ZS5	4-2-56
1N4358		1M200ZS10	4-2-56
1N4358A		1M200ZS10	4-2-56
1N4358B		1M200ZS5	4-2-56
1N4360		1N5221B	4-2-31
1N4370	1N4370		4-2-28
1N4370A	1N4370A		4-2-28
1N4371	1N4371		4-2-28
1N4371A	1N4371A		4-2-28
1N4372	1N4372		4-2-28
1N4372A	1N4372A		4-2-28
1N4400		1N4736	4-2-44

Industry Part Number	Motorola Direct Replacement	Motorola Similar Replacement	Page Number
1N4401		1N4737	4-2-44
1N4402		1N4738	4-2-44
1N4403		1N4739	4-2-44
1N4404		1N4740	4-2-44
1N4405		1N4741	4-2-44
1N4406		1N4742	4-2-44
1N4407		1N4743	4-2-44
1N4408		1N4744	4-2-44
1N4409		1N4745	4-2-44
1N4410		1N4746	4-2-44
1N4411		1N4747	4-2-44
1N4412		1N4748	4-2-44
1N4413		1N4749	4-2-44
1N4414		1N4750	4-2-44
1N4415		1N4751	4-2-44
1N4416		1N4752	4-2-44
1N4417		1N4753	4-2-44
1N4418		1N4754	4-2-44
1N4419		1N4755	4-2-44
1N4420		1N4756	4-2-44
1N4421		1N4757	4-2-44
1N4422		1N4758	4-2-44
1N4423		1N4759	4-2-44
1N4424		1N4760	4-2-44
1N4425		1N4761	4-2-44
1N4426		1N4762	4-2-44
1N4427		1N4763	4-2-44
1N4428		1N4764	4-2-44
1N4429		1M110ZS10	4-2-56
1N4430		1M120ZS10	4-2-56
1N4431		1M130ZS10	4-2-56
1N4432		1M150ZS10	4-2-56
1N4433		1M160ZS10	4-2-56
1N4434		1M180ZS10	4-2-56
1N4435		1M200ZS10	4-2-56
1N4460		1N4735A	4-2-44
1N4461		1N4736A	4-2-44
1N4462		1N4737A	4-2-44
1N4463		1N4738A	4-2-44
1N4464		1N4739A	4-2-44
1N4465		1N4740A	4-2-44
1N4466		1N4741A	4-2-44
1N4467		1N4742A	4-2-44
1N4468		1N4743A	4-2-44
1N4469		1N4744A	4-2-44
1N4470		1N4745A	4-2-44
1N4471		1N4746A	4-2-44
1N4472		1N4747A	4-2-44
1N4473		1N4748A	4-2-44
1N4474		1N4749A	4-2-44
1N4475		1N4750A	4-2-44

CF = consult factory representative

CROSS-REFERENCE (continued)

Industry Part Number	Motorola Direct Replacement	Motorola Similar Replacement	Page Number
1N4476		1N4751A	4-2-44
1N4477		1N4752A	4-2-44
1N4478		1N4753A	4-2-44
1N4479		1N4754A	4-2-44
1N4480		1N4755A	4-2-44
1N4481		1N4756A	4-2-44
1N4482		1N4757A	4-2-44
1N4483		1N4758A	4-2-44
1N4484		1N4759A	4-2-44
1N4485		1N4760A	4-2-44
1N4486		1N4761A	4-2-44
1N4487		1N4762A	4-2-44
1N4488		1N4763A	4-2-44
1N4489		1N4764A	4-2-44
1N4490		1M110ZS5	4-2-56
1N4491		1M120ZS5	4-2-56
1N4492		1M130ZS5	4-2-56
1N4493		1M150ZS5	4-2-56
1N4494		1M160ZS5	4-2-56
1N4495		1M180ZS5	4-2-56
1N4496		1M200ZS5	4-2-56
1N4499		1N4735A	4-2-44
1N4503		3EZ33D10	4-2-53
1N4504		3EZ200D10	4-2-54
1N4565	1N4565		4-3-15
1N4565A	1N4565A		4-3-15
1N4566	1N4566		4-3-15
1N4566A	1N4566A		4-3-15
1N4567	1N4567		4-3-15
1N4567A	1N4567A		4-3-15
1N4568	1N4568		4-3-15
1N4568A	1N4568A		4-3-15
1N4569	1N4569		4-3-15
1N4569A	1N4569A		4-3-15
1N4570	1N4570		4-3-15
1N4570A	1N4570A		4-3-15
1N4571	1N4571		4-3-15
1N4571A	1N4571A		4-3-15
1N4572	1N4572		4-3-15
1N4572A	1N4572A		4-3-15
1N4573	1N4573		4-3-15
1N4573A	1N4573A		4-3-15
1N4574	1N4574		4-3-15
1N4574A	1N4574A		4-3-15
1N4575	1N4575		CF
1N4575A	1N4575A		CF
1N4576	1N4576		CF
1N4576A	1N4576A		CF
1N4577	1N4577		CF
1N4577A	1N4577A		CF
1N4578	1N4578		CF

Industry Part Number	Motorola Direct Replacement	Motorola Similar Replacement	Page Number
1N4578A	1N4578A		CF
1N4579	1N4579		CF
1N4579A	1N4579A		CF
1N4580	1N4580		CF
1N4580A	1N4580A		CF
1N4581	1N4581		CF
1N4581A	1N4581A		CF
1N4582	1N4582		CF
1N4582A	1N4582A		CF
1N4583	1N4583		CF
1N4583A	1N4583A		CF
1N4584	1N4584		CF
1N4584A	1N4584A		CF
1N4614		MZ4614	4-2-37
1N4615		MZ4615	4-2-37
1N4616		MZ4616	4-2-37
1N4617		MZ4617	4-2-37
1N4618		MZ4618	4-2-37
1N4619		MZ4619	4-2-37
1N4620		MZ4620	4-2-37
1N4621		MZ4621	4-2-37
1N4622		MZ4622	4-2-37
1N4623		MZ4623	4-2-37
1N4624		MZ4624	4-2-37
1N4625		MZ4625	4-2-37
1N4626		MZ4626	4-2-37
1N4627		MZ4627	4-2-37
1N4628		1N4736A	4-2-44
1N4629		1N4737A	4-2-44
1N4630		1N4738A	4-2-44
1N4631		1N4739A	4-2-44
1N4632		1N4740A	4-2-44
1N4633		1N4741A	4-2-44
1N4634		1N4742A	4-2-44
1N4635		1N4743A	4-2-44
1N4636		1N4744A	4-2-44
1N4637		1N4745A	4-2-44
1N4638		1N4746A	4-2-44
1N4639		1N4747A	4-2-44
1N4640		1N4748A	4-2-44
1N4641		1N4749A	4-2-44
1N4642		1N4750A	4-2-44
1N4643		1N4751A	4-2-44
1N4644		1N4752A	4-2-44
1N4645		1N4753A	4-2-44
1N4646		1N4754A	4-2-44
1N4647		1N4755A	4-2-44
1N4648		1N4756A	4-2-44
1N4649		1N4728A	4-2-44
1N465		1N5223A	4-2-31
1N4650		1N4729A	4-2-44

2

CF = consult factory representative

CROSS-REFERENCE (continued)

2

Industry Part Number	Motorola Direct Replacement	Motorola Similar Replacement	Page Number
1N4651		1N4730A	4-2-44
1N4652		1N4731A	4-2-44
1N4653		1N4732A	4-2-44
1N4654		1N4733A	4-2-44
1N4655		1N4734A	4-2-44
1N4656		1N4735A	4-2-44
1N4657		1N4736A	4-2-44
1N4658		1N4737A	4-2-44
1N4659		1N4738A	4-2-44
1N465A		1N5223B	4-2-31
1N466		1N5226A	4-2-31
1N4660		1N4739A	4-2-44
1N4661		1N4740A	4-2-44
1N4662		1N4741A	4-2-44
1N4663		1N4742A	4-2-44
1N4664		1N4743A	4-2-44
1N4665		1N4744A	4-2-44
1N4666		1N4745A	4-2-44
1N4667		1N4746A	4-2-44
1N4668		1N4747A	4-2-44
1N4669		1N4748A	4-2-44
1N466A		1N5226B	4-2-31
1N467		1N5228B	4-2-31
1N4670		1N4749A	4-2-44
1N4671		1N4750A	4-2-44
1N4672		1N4751A	4-2-44
1N4673		1N4752A	4-2-44
1N4674		1N4753A	4-2-44
1N4675		1N4754A	4-2-44
1N4676		1N4755A	4-2-44
1N4677		1N4756A	4-2-44
1N4678	1N4678		4-2-30
1N4678C	1N4678C		4-2-30
1N4678D	1N4678D		4-2-30
1N4679	1N4679		4-2-30
1N4679C	1N4679C		4-2-30
1N4679D	1N4679D		4-2-30
1N467A		1N5228B	4-2-31
1N468		1N5230A	4-2-31
1N4680	1N4680		4-2-30
1N4680C	1N4680C		4-2-30
1N4680D	1N4680D		4-2-30
1N4681	1N4681		4-2-30
1N4681C	1N4681C		4-2-30
1N4681D	1N4681D		4-2-30
1N4682	1N4682		4-2-30
1N4682C	1N4682C		4-2-30
1N4682D	1N4682D		4-2-30
1N4683	1N4683		4-2-30
1N4683C	1N4683C		4-2-30
1N4683D	1N4683D		4-2-30

Industry Part Number	Motorola Direct Replacement	Motorola Similar Replacement	Page Number
1N4684	1N4684		4-2-30
1N4684C	1N4684C		4-2-30
1N4684D	1N4684D		4-2-30
1N4685	1N4685		4-2-30
1N4685C	1N4685C		4-2-30
1N4685D	1N4685D		4-2-30
1N4686	1N4686		4-2-30
1N4686C	1N4686C		4-2-30
1N4686D	1N4686D		4-2-30
1N4687	1N4687		4-2-30
1N4687C	1N4687C		4-2-30
1N4687D	1N4687D		4-2-30
1N4688	1N4688		4-2-30
1N4688C	1N4688C		4-2-30
1N4688D	1N4688D		4-2-30
1N4689	1N4689		4-2-30
1N4689C	1N4689C		4-2-30
1N4689D	1N4689D		4-2-30
1N468A		1N5230B	4-2-31
1N469		1N5232B	4-2-31
1N4690	1N4690		4-2-30
1N4690C	1N4690C		4-2-30
1N4690D	1N4690D		4-2-30
1N4691	1N4691		4-2-30
1N4691C	1N4691C		4-2-30
1N4691D	1N4691D		4-2-30
1N4692	1N4692		4-2-30
1N4692C	1N4692C		4-2-30
1N4692D	1N4692D		4-2-30
1N4693	1N4693		4-2-30
1N4693C	1N4693C		4-2-30
1N4693D	1N4693D		4-2-30
1N4694	1N4694		4-2-30
1N4694C	1N4694C		4-2-30
1N4694D	1N4694D		4-2-30
1N4695	1N4695		4-2-30
1N4695C	1N4695C		4-2-30
1N4695D	1N4695D		4-2-30
1N4696	1N4696		4-2-30
1N4696C	1N4696C		4-2-30
1N4696D	1N4696D		4-2-30
1N4697	1N4697		4-2-30
1N4697C	1N4697C		4-2-30
1N4697D	1N4697D		4-2-30
1N4698	1N4698		4-2-30
1N4698C	1N4698C		4-2-30
1N4698D	1N4698D		4-2-30
1N4699	1N4699		4-2-30
1N4699C	1N4699C		4-2-30
1N4699D	1N4699D		4-2-30
1N469A		1N5232B	4-2-31

CF = consult factory representative

CROSS-REFERENCE (continued)

Industry Part Number	Motorola Direct Replacement	Motorola Similar Replacement	Page Number
1N470		1N5235B	4-2-31
1N4700	1N4700		4-2-30
1N4700C	1N4700C		4-2-30
1N4700D	1N4700D		4-2-30
1N4701	1N4701		4-2-30
1N4701C	1N4701C		4-2-30
1N4701D	1N4701D		4-2-30
1N4702	1N4702		4-2-30
1N4702C	1N4702C		4-2-30
1N4702D	1N4702D		4-2-30
1N4703	1N4703		4-2-30
1N4703C	1N4703C		4-2-30
1N4703D	1N4703D		4-2-30
1N4704	1N4704		4-2-30
1N4704C	1N4704C		4-2-30
1N4704D	1N4704D		4-2-30
1N4705	1N4705		4-2-30
1N4705C	1N4705C		4-2-30
1N4705D	1N4705D		4-2-30
1N4706	1N4706		4-2-30
1N4706C	1N4706C		4-2-30
1N4706D	1N4706D		4-2-30
1N4707	1N4707		4-2-30
1N4707C	1N4707C		4-2-30
1N4707D	1N4707D		4-2-30
1N4708	1N4708		4-2-30
1N4708C	1N4708C		4-2-30
1N4708D	1N4708D		4-2-30
1N4709	1N4709		4-2-30
1N4709C	1N4709C		4-2-30
1N4709D	1N4709D		4-2-30
1N470A		1N5235B	4-2-31
1N4710	1N4710		4-2-30
1N4710C	1N4710C		4-2-30
1N4710D	1N4710D		4-2-30
1N4711	1N4711		4-2-30
1N4711C	1N4711C		4-2-30
1N4711D	1N4711D		4-2-30
1N4712	1N4712		4-2-30
1N4712C	1N4712C		4-2-30
1N4712D	1N4712D		4-2-30
1N4713	1N4713		4-2-30
1N4713C	1N4713C		4-2-30
1N4713D	1N4713D		4-2-30
1N4714	1N4714		4-2-30
1N4714C	1N4714C		4-2-30
1N4714D	1N4714D		4-2-30
1N4715	1N4715		4-2-30
1N4715C	1N4715C		4-2-30
1N4715D	1N4715D		4-2-30
1N4716	1N4716		4-2-30

Industry Part Number	Motorola Direct Replacement	Motorola Similar Replacement	Page Number
1N4716C	1N4716C		4-2-30
1N4716D	1N4716D		4-2-30
1N4717	1N4717		4-2-30
1N4717C	1N4717C		4-2-30
1N4717D	1N4717D		4-2-30
1N4728	1N4728		4-2-44
1N4728A	1N4728A		4-2-44
1N4728C	1N4728C		4-2-44
1N4728D	1N4728D		4-2-44
1N4729	1N4729		4-2-44
1N4729A	1N4729A		4-2-44
1N4729C	1N4729C		4-2-44
1N4729D	1N4729D		4-2-44
1N4730	1N4730		4-2-44
1N4730A	1N4730A		4-2-44
1N4730C	1N4730C		4-2-44
1N4730D	1N4730D		4-2-44
1N4731	1N4731		4-2-44
1N4731A	1N4731A		4-2-44
1N4731C	1N4731C		4-2-44
1N4731D	1N4731D		4-2-44
1N4732	1N4732		4-2-44
1N4732A	1N4732A		4-2-44
1N4732C	1N4732C		4-2-44
1N4732D	1N4732D		4-2-44
1N4733	1N4733		4-2-44
1N4733A	1N4733A		4-2-44
1N4733C	1N4733C		4-2-44
1N4733D	1N4733D		4-2-44
1N4734	1N4734		4-2-44
1N4734A	1N4734A		4-2-44
1N4734C	1N4734C		4-2-44
1N4734D	1N4734D		4-2-44
1N4735	1N4735		4-2-44
1N4735A	1N4735A		4-2-44
1N4735C	1N4735C		4-2-44
1N4735D	1N4735D		4-2-44
1N4736	1N4736		4-2-44
1N4736A	1N4736A		4-2-44
1N4736C	1N4736C		4-2-44
1N4736D	1N4736D		4-2-44
1N4737	1N4737		4-2-44
1N4737A	1N4737A		4-2-44
1N4737C	1N4737C		4-2-44
1N4737D	1N4737D		4-2-44
1N4738	1N4738		4-2-44
1N4738A	1N4738A		4-2-44
1N4738C	1N4738C		4-2-44
1N4738D	1N4738D		4-2-44
1N4739	1N4739		4-2-44
1N4739A	1N4739A		4-2-44



CF = consult factory representative

CROSS-REFERENCE (continued)

2

Industry Part Number	Motorola Direct Replacement	Motorola Similar Replacement	Page Number
1N4739C	1N4739C		4-2-44
1N4739D	1N4739D		4-2-44
1N4740	1N4740		4-2-44
1N4740A	1N4740A		4-2-44
1N4740C	1N4740C		4-2-44
1N4740D	1N4740D		4-2-44
1N4741	1N4741		4-2-44
1N4741A	1N4741A		4-2-44
1N4741C	1N4741C		4-2-44
1N4741D	1N4741D		4-2-44
1N4742	1N4742		4-2-44
1N4742A	1N4742A		4-2-44
1N4742C	1N4742C		4-2-44
1N4742D	1N4742D		4-2-44
1N4743	1N4743		4-2-44
1N4743A	1N4743A		4-2-44
1N4743C	1N4743C		4-2-44
1N4743D	1N4743D		4-2-44
1N4744	1N4744		4-2-44
1N4744A	1N4744A		4-2-44
1N4744C	1N4744C		4-2-44
1N4744D	1N4744D		4-2-44
1N4745	1N4745		4-2-44
1N4745A	1N4745A		4-2-44
1N4745C	1N4745C		4-2-44
1N4745D	1N4745D		4-2-44
1N4746	1N4746		4-2-44
1N4746A	1N4746A		4-2-44
1N4746C	1N4746C		4-2-44
1N4746D	1N4746D		4-2-44
1N4747	1N4747		4-2-44
1N4747A	1N4747A		4-2-44
1N4747C	1N4747C		4-2-44
1N4747D	1N4747D		4-2-44
1N4748	1N4748		4-2-44
1N4748A	1N4748A		4-2-44
1N4748C	1N4748C		4-2-44
1N4748D	1N4748D		4-2-44
1N4749	1N4749		4-2-44
1N4749A	1N4749A		4-2-44
1N4749C	1N4749C		4-2-44
1N4749D	1N4749D		4-2-44
1N4750	1N4750		4-2-44
1N4750A	1N4750A		4-2-44
1N4750C	1N4750C		4-2-44
1N4750D	1N4750D		4-2-44
1N4751	1N4751		4-2-44
1N4751A	1N4751A		4-2-44
1N4751C	1N4751C		4-2-44
1N4751D	1N4751D		4-2-44
1N4752	1N4752		4-2-44

Industry Part Number	Motorola Direct Replacement	Motorola Similar Replacement	Page Number
1N4752A	1N4752A		4-2-44
1N4752C	1N4752C		4-2-44
1N4752D	1N4752D		4-2-44
1N4753	1N4753		4-2-44
1N4753A	1N4753A		4-2-44
1N4753C	1N4753C		4-2-44
1N4753D	1N4753D		4-2-44
1N4754	1N4754		4-2-44
1N4754A	1N4754A		4-2-44
1N4754C	1N4754C		4-2-44
1N4754D	1N4754D		4-2-44
1N4755	1N4755		4-2-44
1N4755A	1N4755A		4-2-44
1N4755C	1N4755C		4-2-44
1N4755D	1N4755D		4-2-44
1N4756	1N4756		4-2-44
1N4756A	1N4756A		4-2-44
1N4756C	1N4756C		4-2-44
1N4756D	1N4756D		4-2-44
1N4757	1N4757		4-2-44
1N4757A	1N4757A		4-2-44
1N4757C	1N4757C		4-2-44
1N4757D	1N4757D		4-2-44
1N4758	1N4758		4-2-44
1N4758A	1N4758A		4-2-44
1N4758C	1N4758C		4-2-44
1N4758D	1N4758D		4-2-44
1N4759	1N4759		4-2-44
1N4759A	1N4759A		4-2-44
1N4759C	1N4759C		4-2-44
1N4759D	1N4759D		4-2-44
1N4760	1N4760		4-2-44
1N4760A	1N4760A		4-2-44
1N4760C	1N4760C		4-2-44
1N4760D	1N4760D		4-2-44
1N4761	1N4761		4-2-44
1N4761A	1N4761A		4-2-44
1N4761C	1N4761C		4-2-44
1N4761D	1N4761D		4-2-44
1N4762	1N4762		4-2-44
1N4762A	1N4762A		4-2-44
1N4762C	1N4762C		4-2-44
1N4762D	1N4762D		4-2-44
1N4763	1N4763		4-2-44
1N4763A	1N4763A		4-2-44
1N4763C	1N4763C		4-2-44
1N4763D	1N4763D		4-2-44
1N4764	1N4764		4-2-44
1N4764A	1N4764A		4-2-44
1N4764C	1N4764C		4-2-44
1N4764D	1N4764D		4-2-44

CF = consult factory representative

CROSS-REFERENCE (continued)

Industry Part Number	Motorola Direct Replacement	Motorola Similar Replacement	Page Number
1N4831		1N4739	4-2-44
1N4831A		1N4739	4-2-44
1N4831B		1N4739A	4-2-44
1N4832		1N4740	4-2-44
1N4832A		1N4740	4-2-44
1N4832B		1N4740A	4-2-44
1N4833		1N4741	4-2-44
1N4833A		1N4741	4-2-44
1N4833B		1N4741A	4-2-44
1N4834		1N4742	4-2-44
1N4834A		1N4742	4-2-44
1N4834B		1N4742A	4-2-44
1N4835		1N4743	4-2-44
1N4835A		1N4743	4-2-44
1N4835B		1N4743A	4-2-44
1N4836		1N4744	4-2-44
1N4836A		1N4744	4-2-44
1N4836B		1N4744A	4-2-44
1N4837		1N4745	4-2-44
1N4837A		1N4745	4-2-44
1N4837B		1N4745A	4-2-44
1N4838		1N4746	4-2-44
1N4838A		1N4746	4-2-44
1N4838B		1N4746A	4-2-44
1N4839		1N4747	4-2-44
1N4839A		1N4747	4-2-44
1N4839B		1N4747A	4-2-44
1N4840		1N4748	4-2-44
1N4840A		1N4748	4-2-44
1N4840B		1N4748A	4-2-44
1N4841		1N4749	4-2-44
1N4841A		1N4749	4-2-44
1N4841B		1N4749A	4-2-44
1N4842		1N4750	4-2-44
1N4842A		1N4750	4-2-44
1N4842B		1N4750A	4-2-44
1N4843		1N4751	4-2-44
1N4843A		1N4751	4-2-44
1N4843B		1N4751A	4-2-44
1N4844		1N4752	4-2-44
1N4844A		1N4752	4-2-44
1N4844B		1N4752A	4-2-44
1N4845		1N4753	4-2-44
1N4845A		1N4753	4-2-44
1N4845B		1N4753A	4-2-44
1N4846		1N4754	4-2-44
1N4846A		1N4754	4-2-44
1N4846B		1N4754A	4-2-44
1N4847		1N4755	4-2-44
1N4847A		1N4755	4-2-44
1N4847B		1N4755A	4-2-44

Industry Part Number	Motorola Direct Replacement	Motorola Similar Replacement	Page Number
1N4848		1N4756	4-2-44
1N4848A		1N4756	4-2-44
1N4848B		1N4756A	4-2-44
1N4849		1N4757	4-2-44
1N4849A		1N4757	4-2-44
1N4849B		1N4757A	4-2-44
1N4850		1N4758	4-2-44
1N4850A		1N4758	4-2-44
1N4850B		1N4758A	4-2-44
1N4851		1N4759	4-2-44
1N4851A		1N4759	4-2-44
1N4851B		1N4759A	4-2-44
1N4852		1N4760	4-2-44
1N4852A		1N4760	4-2-44
1N4852B		1N4760A	4-2-44
1N4853		1N4761	4-2-44
1N4853A		1N4761	4-2-44
1N4853B		1N4761A	4-2-44
1N4854		1N4762	4-2-44
1N4854A		1N4762	4-2-44
1N4854B		1N4762A	4-2-44
1N4855		1N4763	4-2-44
1N4855A		1N4763	4-2-44
1N4855B		1N4763A	4-2-44
1N4856		1N4764	4-2-44
1N4856A		1N4764	4-2-44
1N4856B		1N4764A	4-2-44
1N4857		1M110ZS10	4-2-56
1N4857A		1M110ZS10	4-2-56
1N4857B		1M110ZS5	4-2-56
1N4858		1M120ZS10	4-2-56
1N4858A		1M120ZS10	4-2-56
1N4858B		1M120ZS5	4-2-56
1N4859		1M130ZS10	4-2-56
1N4859A		1M130ZS10	4-2-56
1N4859B		1M130ZS5	4-2-56
1N4860		1M150ZS10	4-2-56
1N4860A		1M150ZS10	4-2-56
1N4860B		1M150ZS5	4-2-56
1N4881		3EZ39D5	4-2-53
1N4882		3EZ20D5	4-2-53
1N4883		3EZ62D5	4-2-53
1N4884		3EZ39D5	4-2-53
1N4889		1N5372B	4-2-59
1N4954		1N5342B	4-2-59
1N4955		1N5343B	4-2-59
1N4956		1N5344B	4-2-59
1N4957		1N5346B	4-2-59
1N4958		1N5347B	4-2-59
1N4959		1N5348B	4-2-59
1N4960		1N5349B	4-2-59



CF = consult factory representative

CROSS-REFERENCE (continued)

2

Industry Part Number	Motorola Direct Replacement	Motorola Similar Replacement	Page Number
1N4961		1N5350B	4-2-59
1N4962		1N5352B	4-2-59
1N4963		1N5353B	4-2-59
1N4964		1N5355B	4-2-59
1N4965		1N5357B	4-2-59
1N4966		1N5358B	4-2-59
1N4967		1N5359B	4-2-59
1N4968		1N5361B	4-2-59
1N4969		1N5363B	4-2-59
1N4970		1N5364B	4-2-59
1N4971		1N5365B	4-2-59
1N4972		1N5366B	4-2-59
1N4973		1N5367B	4-2-59
1N4974		1N5368B	4-2-59
1N4975		1N5369B	4-2-59
1N4976		1N5370B	4-2-59
1N4977		1N5372B	4-2-59
1N4978		1N5373B	4-2-59
1N4979		1N5374B	4-2-59
1N4980		1N5375B	4-2-59
1N4981		1N5377B	4-2-59
1N4982		1N5378B	4-2-59
1N4983		1N5379B	4-2-59
1N4984		1N5380B	4-2-59
1N4985		1N5381B	4-2-59
1N4986		1N5383B	4-2-60
1N4987		1N5384B	4-2-60
1N4988		1N5386B	4-2-60
1N4989		1N5388B	4-2-60
1N5008		1N5333A	4-2-59
1N5008A		1N5333B	4-2-59
1N5009		1N5334A	4-2-59
1N5009A		1N5334B	4-2-59
1N5010		3EZ3.9D10	4-2-53
1N5010A		3EZ3.9D5	4-2-53
1N5011		3EZ4.3D10	4-2-53
1N5011A		3EZ4.3D5	4-2-53
1N5012		3EZ4.7D10	4-2-53
1N5012A		3EZ4.7D5	4-2-53
1N5013		3EZ5.1D10	4-2-53
1N5013A		3EZ5.1D5	4-2-53
1N5014		3EZ5.6D10	4-2-53
1N5014A		3EZ5.6D5	4-2-53
1N5015		3EZ6.2D10	4-2-53
1N5015A		3EZ6.2D5	4-2-53
1N5016		3EZ6.8D10	4-2-53
1N5016A		3EZ6.8D5	4-2-53
1N5017		3EZ7.5D10	4-2-53
1N5017A		3EZ7.5D5	4-2-53
1N5018		3EZ8.2D10	4-2-53
1N5018A		3EZ8.2D5	4-2-53

Industry Part Number	Motorola Direct Replacement	Motorola Similar Replacement	Page Number
1N5019		3EZ9.1D10	4-2-53
1N5019A		3EZ9.1D5	4-2-53
1N5020		3EZ10D10	4-2-53
1N5020A		3EZ10D5	4-2-53
1N5021		3EZ11D10	4-2-53
1N5021A		3EZ11D5	4-2-53
1N5022		3EZ12D10	4-2-53
1N5022A		3EZ12D5	4-2-53
1N5023		3EZ13D10	4-2-53
1N5023A		3EZ13D5	4-2-53
1N5024		3EZ14D10	4-2-53
1N5024A		3EZ14D5	4-2-53
1N5025		3EZ15D10	4-2-53
1N5025A		3EZ15D5	4-2-53
1N5026		3EZ16D10	4-2-53
1N5026A		3EZ16D5	4-2-53
1N5027		3EZ17D10	4-2-53
1N5027A		3EZ17D5	4-2-53
1N5028		3EZ18D10	4-2-53
1N5028A		3EZ18D5	4-2-53
1N5029		3EZ19D10	4-2-53
1N5029A		3EZ19D5	4-2-53
1N5030		3EZ20D10	4-2-53
1N5030A		3EZ20D5	4-2-53
1N5031		3EZ22D10	4-2-53
1N5031A		3EZ22D5	4-2-53
1N5032		3EZ24D10	4-2-53
1N5032A		3EZ24D5	4-2-53
1N5033		3EZ24D5	4-2-53
1N5033A		3EZ24D5	4-2-53
1N5034		3EZ27D10	4-2-53
1N5034A		3EZ27D5	4-2-53
1N5035		3EZ30D10	4-2-54
1N5035A		3EZ30D5	4-2-53
1N5036		3EZ33D10	4-2-53
1N5036A		3EZ33D5	4-2-53
1N5037		3EZ36D10	4-2-53
1N5037A		3EZ36D5	4-2-53
1N5038		3EZ39D10	4-2-53
1N5038A		3EZ39D5	4-2-53
1N5039		3EZ43D10	4-2-53
1N5039A		3EZ43D5	4-2-53
1N5040		3EZ47D5	4-2-53
1N5040A		3EZ47D5	4-2-53
1N5041		3EZ47D5	4-2-53
1N5041A		3EZ47D5	4-2-53
1N5042		3EZ51D5	4-2-53
1N5042A		3EZ51D5	4-2-53
1N5043		3EZ51D10	4-2-53
1N5043A		3EZ51D5	4-2-53
1N5044		3EZ51D5	4-2-53

CF = consult factory representative

CROSS-REFERENCE (continued)

Industry Part Number	Motorola Direct Replacement	Motorola Similar Replacement	Page Number	Industry Part Number	Motorola Direct Replacement	Motorola Similar Replacement	Page Number
1N5044A		3EZ51D5	4-2-53	1N5099		3EZ140D5	4-2-53
1N5045		3EZ56D10	4-2-53	1N5100		3EZ160D5	4-2-53
1N5045A		3EZ56D5	4-2-53	1N5101		3EZ170D5	4-2-53
1N5046		3EZ62D10	4-2-53	1N5102		3EZ180D5	4-2-53
1N5046A		3EZ62D5	4-2-53	1N5103		3EZ190D5	4-2-53
1N5047		3EZ68D10	4-2-53	1N5104		3EZ200D5	4-2-54
1N5047A		3EZ68D5	4-2-53	1N5105		3EZ220D5	4-2-54
1N5048		3EZ75D10	4-2-53	1N5106		3EZ240D5	4-2-54
1N5048A		3EZ75D5	4-2-53	1N5107		3EZ270D5	4-2-54
1N5049		3EZ82D10	4-2-53	1N5108		3EZ270D5	4-2-54
1N5049A		3EZ82D5	4-2-53	1N5109		3EZ270D5	4-2-54
1N5050		3EZ91D10	4-2-53	1N5110		3EZ300D5	4-2-54
1N5050A		3EZ91D5	4-2-53	1N5111		3EZ330D5	4-2-54
1N5051		3EZ100D10	4-2-53	1N5112		3EZ330D5	4-2-54
1N5051A		3EZ100D5	4-2-53	1N5113		3EZ330D5	4-2-54
1N5063		3EZ6.8D5	4-2-53	1N5114		3EZ360D5	4-2-54
1N5064		3EZ7.5D5	4-2-53	1N5115		3EZ400D5	4-2-54
1N5065		3EZ8.2D5	4-2-53	1N5116		3EZ400D5	4-2-54
1N5066		3EZ9.1D5	4-2-53	1N5117		3EZ400D5	4-2-54
1N5067		3EZ10D5	4-2-53	1N5118		1N5351B	4-2-59
1N5068		3EZ11D5	4-2-53	1N5119		1N5366B	4-2-59
1N5069		3EZ13D5	4-2-53	1N5120		1N5368B	4-2-59
1N5070		3EZ14D5	4-2-53	1N5121		1N5369B	4-2-59
1N5071		3EZ15D5	4-2-53	1N5122		1N5371B	4-2-59
1N5072		3EZ16D5	4-2-53	1N5123		1N5373B	4-2-59
1N5073		3EZ18D5	4-2-53	1N5124		1N5375B	4-2-59
1N5074		3EZ22D5	4-2-53	1N5125		1N5377B	4-2-59
1N5075		3EZ24D5	4-2-53	1N5126		1N5382B	4-2-59
1N5076		3EZ27D5	4-2-53	1N5127		1N5385B	4-2-60
1N5077		3EZ30D5	4-2-53	1N5128		1N5387B	4-2-60
1N5078		3EZ33D5	4-2-53	1N5221	1N5221A		4-2-31
1N5079		3EZ36D5	4-2-53	1N5221A	1N5221A		4-2-31
1N5080		3EZ39D5	4-2-53	1N5221B	1N5221B		4-2-31
1N5081		3EZ39D5	4-2-53	1N5221C	1N5221C		4-2-31
1N5082		3EZ43D5	4-2-53	1N5221D	1N5221D		4-2-31
1N5083		3EZ47D5	4-2-53	1N5222	1N5222A		4-2-31
1N5084		3EZ47D5	4-2-53	1N5222A	1N5222A		4-2-31
1N5085		3EZ51D5	4-2-53	1N5222B	1N5222B		4-2-31
1N5086		3EZ51D5	4-2-53	1N5222C	1N5222C		4-2-31
1N5087		3EZ56D5	4-2-53	1N5222D	1N5222D		4-2-31
1N5088		3EZ62D5	4-2-53	1N5223	1N5223A		4-2-31
1N5089		3EZ62D5	4-2-53	1N5223A	1N5223A		4-2-31
1N5090		3EZ68D5	4-2-53	1N5223B	1N5223B		4-2-31
1N5091		3EZ68D5	4-2-53	1N5223C	1N5223C		4-2-31
1N5092		3EZ75D5	4-2-53	1N5223D	1N5223D		4-2-31
1N5093		3EZ82D5	4-2-53	1N5224	1N5224A		4-2-31
1N5094		3EZ82D5	4-2-53	1N5224A	1N5224A		4-2-31
1N5095		3EZ91D5	4-2-53	1N5224B	1N5224B		4-2-31
1N5096		3EZ110D5	4-2-53	1N5224C	1N5224C		4-2-31
1N5097		3EZ120D5	4-2-53	1N5224D	1N5224D		4-2-31
1N5098		3EZ130D5	4-2-53	1N5225	1N5225A		4-2-31

CF = consult factory representative



CROSS-REFERENCE (continued)

2

Industry Part Number	Motorola Direct Replacement	Motorola Similar Replacement	Page Number
1N5225A	1N5225A		4-2-31
1N5225B	1N5225B		4-2-31
1N5225C	1N5225C		4-2-31
1N5225D	1N5225D		4-2-31
1N5226	1N5226A		4-2-31
1N5226A	1N5226A		4-2-31
1N5226B	1N5226B		4-2-31
1N5226C	1N5226C		4-2-31
1N5226D	1N5226D		4-2-31
1N5227	1N5227A		4-2-31
1N5227A	1N5227A		4-2-31
1N5227B	1N5227B		4-2-31
1N5227C	1N5227C		4-2-31
1N5227D	1N5227D		4-2-31
1N5228	1N5228A		4-2-31
1N5228A	1N5228A		4-2-31
1N5228B	1N5228B		4-2-31
1N5228C	1N5228C		4-2-31
1N5228D	1N5228D		4-2-31
1N5229	1N5229A		4-2-31
1N5229A	1N5229A		4-2-31
1N5229B	1N5229B		4-2-31
1N5229C	1N5229C		4-2-31
1N5229D	1N5229D		4-2-31
1N5230	1N5230A		4-2-31
1N5230A	1N5230A		4-2-31
1N5230B	1N5230B		4-2-31
1N5230C	1N5230C		4-2-31
1N5230D	1N5230D		4-2-31
1N5231	1N5231A		4-2-31
1N5231A	1N5231A		4-2-31
1N5231B	1N5231B		4-2-31
1N5231C	1N5231C		4-2-31
1N5231D	1N5231D		4-2-31
1N5232	1N5232A		4-2-31
1N5232A	1N5232A		4-2-31
1N5232B	1N5232B		4-2-31
1N5232C	1N5232C		4-2-31
1N5232D	1N5232D		4-2-31
1N5233	1N5233A		4-2-31
1N5233A	1N5233A		4-2-31
1N5233B	1N5233B		4-2-31
1N5233C	1N5233C		4-2-31
1N5233D	1N5233D		4-2-31
1N5234	1N5234A		4-2-31
1N5234A	1N5234A		4-2-31
1N5234B	1N5234B		4-2-31
1N5234C	1N5234C		4-2-31
1N5234D	1N5234D		4-2-31
1N5235	1N5235A		4-2-31
1N5235A	1N5235A		4-2-31

Industry Part Number	Motorola Direct Replacement	Motorola Similar Replacement	Page Number
1N5235B	1N5235B		4-2-31
1N5235C	1N5235C		4-2-31
1N5235D	1N5235D		4-2-31
1N5236	1N5236A		4-2-31
1N5236A	1N5236A		4-2-31
1N5236B	1N5236B		4-2-31
1N5236C	1N5236C		4-2-31
1N5236D	1N5236D		4-2-31
1N5237	1N5237A		4-2-31
1N5237A	1N5237A		4-2-31
1N5237B	1N5237B		4-2-31
1N5237C	1N5237C		4-2-31
1N5237D	1N5237D		4-2-31
1N5238	1N5238A		4-2-31
1N5238A	1N5238A		4-2-31
1N5238B	1N5238B		4-2-31
1N5238C	1N5238C		4-2-31
1N5238D	1N5238D		4-2-31
1N5239	1N5239A		4-2-31
1N5239A	1N5239A		4-2-31
1N5239B	1N5239B		4-2-31
1N5239C	1N5239C		4-2-31
1N5239D	1N5239D		4-2-31
1N5240	1N5240A		4-2-31
1N5240A	1N5240A		4-2-31
1N5240B	1N5240B		4-2-31
1N5240C	1N5240C		4-2-31
1N5240D	1N5240D		4-2-31
1N5241	1N5241A		4-2-31
1N5241A	1N5241A		4-2-31
1N5241B	1N5241B		4-2-31
1N5241C	1N5241C		4-2-31
1N5241D	1N5241D		4-2-31
1N5242	1N5242A		4-2-31
1N5242A	1N5242A		4-2-31
1N5242B	1N5242B		4-2-31
1N5242C	1N5242C		4-2-31
1N5242D	1N5242D		4-2-31
1N5243	1N5243A		4-2-31
1N5243A	1N5243A		4-2-31
1N5243B	1N5243B		4-2-31
1N5243C	1N5243C		4-2-31
1N5243D	1N5243D		4-2-31
1N5244	1N5244A		4-2-31
1N5244A	1N5244A		4-2-31
1N5244B	1N5244B		4-2-31
1N5244C	1N5244C		4-2-31
1N5244D	1N5244D		4-2-31
1N5245	1N5245A		4-2-31
1N5245A	1N5245A		4-2-31
1N5245B	1N5245B		4-2-31

CF = consult factory representative

CROSS-REFERENCE (continued)

Industry Part Number	Motorola Direct Replacement	Motorola Similar Replacement	Page Number
1N5245C	1N5245C		4-2-31
1N5245D	1N5245D		4-2-31
1N5246	1N5246A		4-2-31
1N5246A	1N5246A		4-2-31
1N5246B	1N5246B		4-2-31
1N5246C	1N5246C		4-2-31
1N5246D	1N5246D		4-2-31
1N5247	1N5247A		4-2-31
1N5247A	1N5247A		4-2-31
1N5247B	1N5247B		4-2-31
1N5247C	1N5247C		4-2-31
1N5247D	1N5247D		4-2-31
1N5248	1N5248A		4-2-31
1N5248A	1N5248A		4-2-31
1N5248B	1N5248B		4-2-31
1N5248C	1N5248C		4-2-31
1N5248D	1N5248D		4-2-31
1N5249	1N5249A		4-2-31
1N5249A	1N5249A		4-2-31
1N5249B	1N5249B		4-2-31
1N5249C	1N5249C		4-2-31
1N5249D	1N5249D		4-2-31
1N5250	1N5250A		4-2-31
1N5250A	1N5250A		4-2-31
1N5250B	1N5250B		4-2-31
1N5250C	1N5250C		4-2-31
1N5250D	1N5250D		4-2-31
1N5251	1N5251A		4-2-31
1N5251A	1N5251A		4-2-31
1N5251B	1N5251B		4-2-31
1N5251C	1N5251C		4-2-31
1N5251D	1N5251D		4-2-31
1N5252	1N5252A		4-2-31
1N5252A	1N5252A		4-2-31
1N5252B	1N5252B		4-2-31
1N5252C	1N5252C		4-2-31
1N5252D	1N5252D		4-2-31
1N5253	1N5253A		4-2-31
1N5253A	1N5253A		4-2-31
1N5253B	1N5253B		4-2-31
1N5253C	1N5253C		4-2-31
1N5253D	1N5253D		4-2-31
1N5254	1N5254A		4-2-31
1N5254A	1N5254A		4-2-31
1N5254B	1N5254B		4-2-31
1N5254C	1N5254C		4-2-31
1N5254D	1N5254D		4-2-31
1N5255	1N5255A		4-2-31
1N5255A	1N5255A		4-2-31
1N5255B	1N5255B		4-2-31
1N5255C	1N5255C		4-2-31

Industry Part Number	Motorola Direct Replacement	Motorola Similar Replacement	Page Number
1N5255D	1N5255D		4-2-31
1N5256	1N5256A		4-2-31
1N5256A	1N5256A		4-2-31
1N5256B	1N5256B		4-2-31
1N5256C	1N5256C		4-2-31
1N5256D	1N5256D		4-2-31
1N5257	1N5257A		4-2-31
1N5257A	1N5257A		4-2-31
1N5257B	1N5257B		4-2-31
1N5257C	1N5257C		4-2-31
1N5257D	1N5257D		4-2-31
1N5258	1N5258A		4-2-31
1N5258A	1N5258A		4-2-31
1N5258B	1N5258B		4-2-31
1N5258C	1N5258C		4-2-31
1N5258D	1N5258D		4-2-31
1N5259	1N5259A		4-2-31
1N5259A	1N5259A		4-2-31
1N5259B	1N5259B		4-2-31
1N5259C	1N5259C		4-2-31
1N5259D	1N5259D		4-2-31
1N5260	1N5260A		4-2-31
1N5260A	1N5260A		4-2-31
1N5260B	1N5260B		4-2-31
1N5260C	1N5260C		4-2-31
1N5260D	1N5260D		4-2-31
1N5261	1N5261A		4-2-31
1N5261A	1N5261A		4-2-31
1N5261B	1N5261B		4-2-31
1N5261C	1N5261C		4-2-31
1N5261D	1N5261D		4-2-31
1N5262	1N5262A		4-2-31
1N5262A	1N5262A		4-2-31
1N5262B	1N5262B		4-2-31
1N5262C	1N5262C		4-2-31
1N5262D	1N5262D		4-2-31
1N5263	1N5263A		4-2-31
1N5263A	1N5263A		4-2-31
1N5263B	1N5263B		4-2-31
1N5263C	1N5263C		4-2-31
1N5263D	1N5263D		4-2-31
1N5264	1N5264A		4-2-31
1N5264A	1N5264A		4-2-31
1N5264B	1N5264B		4-2-31
1N5264C	1N5264C		4-2-31
1N5264D	1N5264D		4-2-31
1N5265	1N5265A		4-2-31
1N5265A	1N5265A		4-2-31
1N5265B	1N5265B		4-2-31
1N5265C	1N5265C		4-2-31
1N5265D	1N5265D		4-2-31



CF = consult factory representative

CROSS-REFERENCE (continued)

2

Industry Part Number	Motorola Direct Replacement	Motorola Similar Replacement	Page Number
1N5266	1N5266A		4-2-32
1N5266A	1N5266A		4-2-32
1N5266B	1N5266B		4-2-32
1N5266C	1N5266C		4-2-32
1N5266D	1N5266D		4-2-32
1N5267	1N5267A		4-2-32
1N5267A	1N5267A		4-2-32
1N5267B	1N5267B		4-2-32
1N5267C	1N5267C		4-2-32
1N5267D	1N5267D		4-2-32
1N5268	1N5268A		4-2-32
1N5268A	1N5268A		4-2-32
1N5268B	1N5268B		4-2-32
1N5268C	1N5268C		4-2-32
1N5268D	1N5268D		4-2-32
1N5269	1N5269A		4-2-32
1N5269A	1N5269A		4-2-32
1N5269B	1N5269B		4-2-32
1N5269C	1N5269C		4-2-32
1N5269D	1N5269D		4-2-32
1N5270	1N5270A		4-2-32
1N5270A	1N5270A		4-2-32
1N5270B	1N5270B		4-2-32
1N5270C	1N5270C		4-2-32
1N5270D	1N5270D		4-2-32
1N5271	1N5271A		4-2-32
1N5271A	1N5271A		4-2-32
1N5271B	1N5271B		4-2-32
1N5271C	1N5271C		4-2-32
1N5271D	1N5271D		4-2-32
1N5272	1N5272A		4-2-32
1N5272A	1N5272A		4-2-32
1N5272B	1N5272B		4-2-32
1N5272C	1N5272C		4-2-32
1N5272D	1N5272D		4-2-32
1N5273	1N5273A		4-2-32
1N5273A	1N5273A		4-2-32
1N5273B	1N5273B		4-2-32
1N5273C	1N5273C		4-2-32
1N5273D	1N5273D		4-2-32
1N5274	1N5274A		4-2-32
1N5274A	1N5274A		4-2-32
1N5274B	1N5274B		4-2-32
1N5274C	1N5274C		4-2-32
1N5274D	1N5274D		4-2-32
1N5275	1N5275A		4-2-32
1N5275A	1N5275A		4-2-32
1N5275B	1N5275B		4-2-32
1N5275C	1N5275C		4-2-32
1N5275D	1N5275D		4-2-32
1N5276	1N5276A		4-2-32

Industry Part Number	Motorola Direct Replacement	Motorola Similar Replacement	Page Number
1N5276A	1N5276A		4-2-32
1N5276B	1N5276B		4-2-32
1N5276C	1N5276C		4-2-32
1N5276D	1N5276D		4-2-32
1N5277	1N5277A		4-2-32
1N5277A	1N5277A		4-2-32
1N5277B	1N5277B		4-2-32
1N5277C	1N5277C		4-2-32
1N5277D	1N5277D		4-2-32
1N5278	1N5278A		4-2-32
1N5278A	1N5278A		4-2-32
1N5278B	1N5278B		4-2-32
1N5278C	1N5278C		4-2-32
1N5278D	1N5278D		4-2-32
1N5279	1N5279A		4-2-32
1N5279A	1N5279A		4-2-32
1N5279B	1N5279B		4-2-32
1N5279C	1N5279C		4-2-32
1N5279D	1N5279D		4-2-32
1N5280	1N5280A		4-2-32
1N5280A	1N5280A		4-2-32
1N5280B	1N5280B		4-2-32
1N5280C	1N5280C		4-2-32
1N5280D	1N5280D		4-2-32
1N5281	1N5281A		4-2-32
1N5281A	1N5281A		4-2-32
1N5281B	1N5281B		4-2-32
1N5281C	1N5281C		4-2-32
1N5281D	1N5281D		4-2-32
1N5283	1N5283		CF
1N5284	1N5284		CF
1N5285	1N5285		CF
1N5286	1N5286		CF
1N5287	1N5287		CF
1N5288	1N5288		CF
1N5289	1N5289		CF
1N5290	1N5290		CF
1N5291	1N5291		CF
1N5292	1N5292		CF
1N5293	1N5293		CF
1N5294	1N5294		CF
1N5295	1N5295		CF
1N5296	1N5296		CF
1N5297	1N5297		CF
1N5298	1N5298		CF
1N5299	1N5299		CF
1N5300	1N5300		CF
1N5301	1N5301		CF
1N5302	1N5302		CF
1N5303	1N5303		CF
1N5304	1N5304		CF

CF = consult factory representative

CROSS-REFERENCE (continued)

Industry Part Number	Motorola Direct Replacement	Motorola Similar Replacement	Page Number	Industry Part Number	Motorola Direct Replacement	Motorola Similar Replacement	Page Number
1N5305	1N5305		CF	1N5341A	1N5341A		4-2-59
1N5306	1N5306		CF	1N5341B	1N5341B		4-2-59
1N5307	1N5307		CF	1N5341C	CF		-
1N5308	1N5308		CF	1N5341D	CF		-
1N5309	1N5309		CF	1N5342	1N5342A		4-2-59
1N5310	1N5310		CF	1N5342A	1N5342A		4-2-59
1N5311	1N5311		CF	1N5342B	1N5342B		4-2-59
1N5312	1N5312		CF	1N5342C	CF		-
1N5313	1N5313		CF	1N5342D	CF		-
1N5314	1N5314		CF	1N5343	1N5343A		4-2-59
1N5333	1N5333A		4-2-59	1N5343A	1N5343A		4-2-59
1N5333A	1N5333A		4-2-59	1N5343B	1N5343B		4-2-59
1N5333B	1N5333B		4-2-59	1N5343C	CF		-
1N5333C	CF		-	1N5343D	CF		-
1N5333D	CF		-	1N5344	1N5344A		4-2-59
1N5334	1N5334A		4-2-59	1N5344A	1N5344A		4-2-59
1N5334A	1N5334A		4-2-59	1N5344B	1N5344B		4-2-59
1N5334B	1N5334B		4-2-59	1N5344C	CF		-
1N5334C	CF		-	1N5344D	CF		-
1N5334D	CF		-	1N5345	1N5345A		4-2-59
1N5335	1N5335A		4-2-59	1N5345A	1N5345A		4-2-59
1N5335A	1N5335A		4-2-59	1N5345B	1N5345B		4-2-59
1N5335B	1N5335B		4-2-59	1N5345C	CF		-
1N5335C	CF		-	1N5345D	CF		-
1N5335D	CF		-	1N5346	1N5346A		4-2-59
1N5336	1N5336A		4-2-59	1N5346A	1N5346A		4-2-59
1N5336A	1N5336A		4-2-59	1N5346B	1N5346B		4-2-59
1N5336B	1N5336B		4-2-59	1N5346C	CF		-
1N5336C	CF		-	1N5346D	CF		-
1N5336D	CF		-	1N5347	1N5347A		4-2-59
1N5337	1N5337A		4-2-59	1N5347A	1N5347A		4-2-59
1N5337A	1N5337A		4-2-59	1N5347B	1N5347B		4-2-59
1N5337B	1N5337B		4-2-59	1N5347C	CF		-
1N5337C	CF		-	1N5347D	CF		-
1N5337D	CF		-	1N5348	1N5348A		4-2-59
1N5338	1N5338A		4-2-59	1N5348A	1N5348A		4-2-59
1N5338A	1N5338A		4-2-59	1N5348B	1N5348B		4-2-59
1N5338B	1N5338B		4-2-59	1N5348C	CF		-
1N5338C	CF		-	1N5348D	CF		-
1N5338D	CF		-	1N5349	1N5349A		4-2-59
1N5339	1N5339A		4-2-59	1N5349A	1N5349A		4-2-59
1N5339A	1N5339A		4-2-59	1N5349B	1N5349B		4-2-59
1N5339B	1N5339B		4-2-59	1N5349C	CF		-
1N5339C	CF		-	1N5349D	CF		-
1N5339D	CF		-	1N5350	1N5350A		4-2-59
1N5340	1N5340A		4-2-59	1N5350A	1N5350A		4-2-59
1N5340A	1N5340A		4-2-59	1N5350B	1N5350B		4-2-59
1N5340B	1N5340B		4-2-59	1N5350C	CF		-
1N5340C	CF		-	1N5350D	CF		-
1N5340D	CF		-	1N5351	1N5351A		4-2-59
1N5341	1N5341A		4-2-59	1N5351A	1N5351A		4-2-59

CF = consult factory representative



CROSS-REFERENCE (continued)

Industry Part Number	Motorola Direct Replacement	Motorola Similar Replacement	Page Number
1N5351B	1N5351B		4-2-59
1N5351C	CF		-
1N5351D	CF		-
1N5352	1N5352A		4-2-59
1N5352A	1N5352A		4-2-59
1N5352B	1N5352B		4-2-59
1N5352C	CF		-
1N5352D	CF		-
1N5353	1N5353A		4-2-59
1N5353A	1N5353A		4-2-59
1N5353B	1N5353B		4-2-59
1N5353C	CF		-
1N5353D	CF		-
1N5354	1N5354A		4-2-59
1N5354A	1N5354A		4-2-59
1N5354B	1N5354B		4-2-59
1N5354C	CF		-
1N5354D	CF		-
1N5355	1N5355A		4-2-59
1N5355A	1N5355A		4-2-59
1N5355B	1N5355B		4-2-59
1N5355C	CF		-
1N5355D	CF		-
1N5356	1N5356A		4-2-59
1N5356A	1N5356A		4-2-59
1N5356B	1N5356B		4-2-59
1N5356C	CF		-
1N5356D	CF		-
1N5357	1N5357A		4-2-59
1N5357A	1N5357A		4-2-59
1N5357B	1N5357B		4-2-59
1N5357C	CF		-
1N5357D	CF		-
1N5358	1N5358A		4-2-59
1N5358A	1N5358A		4-2-59
1N5358B	1N5358B		4-2-59
1N5358C	CF		-
1N5358D	CF		-
1N5359	1N5359A		4-2-59
1N5359A	1N5359A		4-2-59
1N5359B	1N5359B		4-2-59
1N5359C	CF		-
1N5359D	CF		-
1N5360	1N5360A		4-2-59
1N5360A	1N5360A		4-2-59
1N5360B	1N5360B		4-2-59
1N5360C	CF		-
1N5360D	CF		-
1N5361	1N5361A		4-2-59
1N5361A	1N5361A		4-2-59
1N5361B	1N5361B		4-2-59

Industry Part Number	Motorola Direct Replacement	Motorola Similar Replacement	Page Number
1N5361C	CF		-
1N5361D	CF		-
1N5362	1N5362A		4-2-59
1N5362A	1N5362A		4-2-59
1N5362B	1N5362B		4-2-59
1N5362C	CF		-
1N5362D	CF		-
1N5363	1N5363A		4-2-59
1N5363A	1N5363A		4-2-59
1N5363B	1N5363B		4-2-59
1N5363C	CF		-
1N5363D	CF		-
1N5364	1N5364A		4-2-59
1N5364A	1N5364A		4-2-59
1N5364B	1N5364B		4-2-59
1N5364C	CF		-
1N5364D	CF		-
1N5365	1N5365A		4-2-59
1N5365A	1N5365A		4-2-59
1N5365B	1N5365B		4-2-59
1N5365C	CF		-
1N5365D	CF		-
1N5366	1N5366A		4-2-59
1N5366A	1N5366A		4-2-59
1N5366B	1N5366B		4-2-59
1N5366C	CF		-
1N5366D	CF		-
1N5367	1N5367A		4-2-59
1N5367A	1N5367A		4-2-59
1N5367B	1N5367B		4-2-59
1N5367C	CF		-
1N5367D	CF		-
1N5368	1N5368A		4-2-59
1N5368A	1N5368A		4-2-59
1N5368B	1N5368B		4-2-59
1N5368C	CF		-
1N5368D	CF		-
1N5369	1N5369A		4-2-59
1N5369A	1N5369A		4-2-59
1N5369B	1N5369B		4-2-59
1N5369C	CF		-
1N5369D	CF		-
1N5370	1N5370A		4-2-59
1N5370A	1N5370A		4-2-59
1N5370B	1N5370B		4-2-59
1N5370C	CF		-
1N5370D	CF		-
1N5371	1N5371A		4-2-59
1N5371A	1N5371A		4-2-59
1N5371B	1N5371B		4-2-59
1N5371C	CF		-

CF = consult factory representative

CROSS-REFERENCE (continued)

Industry Part Number	Motorola Direct Replacement	Motorola Similar Replacement	Page Number
1N5371D	CF		-
1N5372	1N5372A		4-2-59
1N5372A	1N5372A		4-2-59
1N5372B	1N5372B		4-2-59
1N5372C	CF		-
1N5372D	CF		-
1N5373	1N5373A		4-2-59
1N5373A	1N5373A		4-2-59
1N5373B	1N5373B		4-2-59
1N5373C	CF		-
1N5373D	CF		-
1N5374	1N5374A		4-2-59
1N5374A	1N5374A		4-2-59
1N5374B	1N5374B		4-2-59
1N5374C	CF		-
1N5374D	CF		-
1N5375	1N5375A		4-2-59
1N5375A	1N5375A		4-2-59
1N5375B	1N5375B		4-2-59
1N5375C	CF		-
1N5375D	CF		-
1N5376	1N5376A		4-2-59
1N5376A	1N5376A		4-2-59
1N5376B	1N5376B		4-2-59
1N5376C	CF		-
1N5376D	CF		-
1N5377	1N5377A		4-2-59
1N5377A	1N5377A		4-2-59
1N5377B	1N5377B		4-2-59
1N5377C	CF		-
1N5377D	CF		-
1N5378	1N5378A		4-2-59
1N5378A	1N5378A		4-2-59
1N5378B	1N5378B		4-2-59
1N5378C	CF		-
1N5378D	CF		-
1N5379	1N5379A		4-2-59
1N5379A	1N5379A		4-2-59
1N5379B	1N5379B		4-2-59
1N5379C	CF		-
1N5379D	CF		-
1N5380	1N5380A		4-2-59
1N5380A	1N5380A		4-2-59
1N5380B	1N5380B		4-2-59
1N5380C	CF		-
1N5380D	CF		-
1N5381	1N5381A		4-2-59
1N5381A	1N5381A		4-2-59
1N5381B	1N5381B		4-2-59
1N5381C	CF		-
1N5381D	CF		-

Industry Part Number	Motorola Direct Replacement	Motorola Similar Replacement	Page Number
1N5382	1N5382A		4-2-59
1N5382A	1N5382A		4-2-59
1N5382B	1N5382B		4-2-59
1N5382C	CF		-
1N5382D	CF		-
1N5383	1N5383A		4-2-60
1N5383A	1N5383A		4-2-60
1N5383B	1N5383B		4-2-60
1N5383C	CF		-
1N5383D	CF		-
1N5384	1N5384A		4-2-60
1N5384A	1N5384A		4-2-60
1N5384B	1N5384B		4-2-60
1N5384C	CF		-
1N5384D	CF		-
1N5385	1N5385A		4-2-60
1N5385A	1N5385A		4-2-60
1N5385B	1N5385B		4-2-60
1N5385C	CF		-
1N5385D	CF		-
1N5386	1N5386A		4-2-60
1N5386A	1N5386A		4-2-60
1N5386B	1N5386B		4-2-60
1N5386C	CF		-
1N5386D	CF		-
1N5387	1N5387A		4-2-60
1N5387A	1N5387A		4-2-60
1N5387B	1N5387B		4-2-60
1N5387C	CF		-
1N5387D	CF		-
1N5388	1N5388A		4-2-60
1N5388A	1N5388A		4-2-60
1N5388B	1N5388B		4-2-60
1N5388C	CF		-
1N5388D	CF		-
1N5518		1N5226A	4-2-31
1N5518A		1N5226A	4-2-31
1N5518B		1N5226B	4-2-31
1N5518C		1N5226C	4-2-31
1N5518D		1N5226D	4-2-31
1N5519		1N5227A	4-2-31
1N5519A		1N5227A	4-2-31
1N5519B		1N5227B	4-2-31
1N5519C		1N5227C	4-2-31
1N5519D		1N5227D	4-2-31
1N5520		MZ5520B	4-2-38
1N5520A		MZ5520B	4-2-38
1N5520B		MZ5520B	4-2-38
1N5520C		CF	-
1N5520D		CF	-
1N5521		MZ5521B	4-2-38

CF = consult factory representative



CROSS-REFERENCE (continued)

Industry Part Number	Motorola Direct Replacement	Motorola Similar Replacement	Page Number
1N5521A		MZ5521B	4-2-38
1N5521B		MZ5521B	4-2-38
1N5521C		CF	-
1N5521D		CF	-
1N5522		MZ5522B	4-2-38
1N5522A		MZ5522B	4-2-38
1N5522B		MZ5522B	4-2-38
1N5522C		CF	-
1N5522D		CF	-
1N5523		MZ5523B	4-2-38
1N5523A		MZ5523B	4-2-38
1N5523B		MZ5523B	4-2-38
1N5523C		CF	-
1N5523D		CF	-
1N5524		MZ5524B	4-2-38
1N5524A		MZ5524B	4-2-38
1N5524B		MZ5524B	4-2-38
1N5524C		CF	-
1N5524D		CF	-
1N5525		MZ5525B	4-2-38
1N5525A		MZ5525B	4-2-38
1N5525B		MZ5525B	4-2-38
1N5525C		CF	-
1N5525D		CF	-
1N5526		MZ5526B	4-2-38
1N5526A		MZ5526B	4-2-38
1N5526B		MZ5526B	4-2-38
1N5526C		CF	-
1N5526D		CF	-
1N5527		MZ5527B	4-2-38
1N5527A		MZ5527B	4-2-38
1N5527B		MZ5527B	4-2-38
1N5527C		CF	-
1N5527D		CF	-
1N5528		MZ5528B	4-2-38
1N5528A		MZ5528B	4-2-38
1N5528B		MZ5528B	4-2-38
1N5528C		CF	-
1N5528D		CF	-
1N5529		MZ5529B	4-2-38
1N5529A		MZ5529B	4-2-38
1N5529B		MZ5529B	4-2-38
1N5529C		CF	-
1N5529D		CF	-
1N5530		MZ5530B	4-2-38
1N5530A		MZ5530B	4-2-38
1N5530B		MZ5530B	4-2-38
1N5530C		CF	-
1N5530D		CF	-
1N5531		1N4698	4-2-30
1N5531A		1N4698	4-2-30

Industry Part Number	Motorola Direct Replacement	Motorola Similar Replacement	Page Number
1N5531B		1N4698	4-2-30
1N5531C		1N4698C	4-2-30
1N5531D		1N4698D	4-2-30
1N5532		1N4699	4-2-30
1N5532A		1N4699	4-2-30
1N5532B		1N4699	4-2-30
1N5532C		1N4699C	4-2-30
1N5532D		1N4699D	4-2-30
1N5533		1N4700	4-2-30
1N5533A		1N4700	4-2-30
1N5533B		1N4700	4-2-30
1N5533C		1N4700C	4-2-30
1N5533D		1N4700D	4-2-30
1N5534		1N4701	4-2-30
1N5534A		1N4701	4-2-30
1N5534B		1N4701	4-2-30
1N5534C		1N4701C	4-2-30
1N5534D		1N4701D	4-2-30
1N5535		1N4702	4-2-30
1N5535A		1N4702	4-2-30
1N5535B		1N4702	4-2-30
1N5535C		1N4702C	4-2-30
1N5535D		1N4702D	4-2-30
1N5536		1N4703	4-2-30
1N5536A		1N4703	4-2-30
1N5536B		1N4703	4-2-30
1N5536C		1N4703C	4-2-30
1N5536D		1N4703D	4-2-30
1N5537		1N4704	4-2-30
1N5537A		1N4704	4-2-30
1N5537B		1N4704	4-2-30
1N5537C		1N4704C	4-2-30
1N5537D		1N4704D	4-2-30
1N5538		1N4705	4-2-30
1N5538A		1N4705	4-2-30
1N5538B		1N4705	4-2-30
1N5538C		1N4705C	4-2-30
1N5538D		1N4705D	4-2-30
1N5539		1N4706	4-2-30
1N5539A		1N4706	4-2-30
1N5539B		1N4706	4-2-30
1N5539C		1N4706C	4-2-30
1N5539D		1N4706D	4-2-30
1N5540		1N4707	4-2-30
1N5540A		1N4707	4-2-30
1N5540B		1N4707	4-2-30
1N5540C		1N4707C	4-2-30
1N5540D		1N4707D	4-2-30
1N5541		1N4708	4-2-30
1N5541A		1N4708	4-2-30
1N5541B		1N4708	4-2-30

CF = consult factory representative

CROSS-REFERENCE (continued)

Industry Part Number	Motorola Direct Replacement	Motorola Similar Replacement	Page Number
1N5541C		1N4708C	4-2-30
1N5541D		1N4708D	4-2-30
1N5542		1N4709	4-2-30
1N5542A		1N4709	4-2-30
1N5542B		1N4709	4-2-30
1N5542C		1N4709C	4-2-30
1N5542D		1N4709D	4-2-30
1N5543		1N4710	4-2-30
1N5543A		1N4710	4-2-30
1N5543B		1N4710	4-2-30
1N5543C		1N4710C	4-2-30
1N5543D		1N4710D	4-2-30
1N5544		1N4712	4-2-30
1N5544A		1N4712	4-2-30
1N5544B		1N4712	4-2-30
1N5544C		1N4712C	4-2-30
1N5544D		1N4712D	4-2-30
1N5545		1N4713	4-2-30
1N5545A		1N4713	4-2-30
1N5545B		1N4713	4-2-30
1N5545C		1N4713C	4-2-30
1N5545D		1N4713D	4-2-30
1N5546		1N4714	4-2-30
1N5546A		1N4714	4-2-30
1N5546B		1N4714	4-2-30
1N5546C		1N4714C	4-2-30
1N5546D		1N4714D	4-2-30
1N5555		1N6284A	4-1-43
1N5556		1N6287A	4-1-43
1N5557		1N6289A	4-1-44
1N5558		1N6303A	4-1-44
1N5559		1N4736	4-2-44
1N5559A		1N4736	4-2-44
1N5559B		1N4736A	4-2-44
1N5560		1N4737	4-2-44
1N5560A		1N4737	4-2-44
1N5560B		1N4737A	4-2-44
1N5561		1N4738	4-2-44
1N5561A		1N4738	4-2-44
1N5561B		1N4738A	4-2-44
1N5562		1N4739	4-2-44
1N5562A		1N4739	4-2-44
1N5562B		1N4739A	4-2-44
1N5563		1N4740	4-2-44
1N5563A		1N4740	4-2-44
1N5563B		1N4740A	4-2-44
1N5564		1N4741	4-2-44
1N5564A		1N4741	4-2-44
1N5564B		1N4741A	4-2-44
1N5565		1N4742	4-2-44
1N5565A		1N4742	4-2-44

Industry Part Number	Motorola Direct Replacement	Motorola Similar Replacement	Page Number
1N5565B		1N4742A	4-2-44
1N5566		1N4743	4-2-44
1N5566A		1N4743	4-2-44
1N5566B		1N4743A	4-2-44
1N5567		1N4744	4-2-44
1N5567A		1N4744	4-2-44
1N5567B		1N4744A	4-2-44
1N5568		1N4745	4-2-44
1N5568A		1N4745	4-2-44
1N5568B		1N4745A	4-2-44
1N5569		1N4746	4-2-44
1N5569A		1N4746	4-2-44
1N5569B		1N4746A	4-2-44
1N5570		1N4747	4-2-44
1N5570A		1N4747	4-2-44
1N5570B		1N4747A	4-2-44
1N5571		1N4748	4-2-44
1N5571A		1N4748	4-2-44
1N5571B		1N4748A	4-2-44
1N5572		1N4749	4-2-44
1N5572A		1N4749	4-2-44
1N5572B		1N4749A	4-2-44
1N5573		1N4750	4-2-44
1N5573A		1N4750	4-2-44
1N5573B		1N4750A	4-2-44
1N5574		1N4751	4-2-44
1N5574A		1N4751	4-2-44
1N5574B		1N4751A	4-2-44
1N5575		1N4752	4-2-44
1N5575A		1N4752	4-2-44
1N5575B		1N4752A	4-2-44
1N5576		1N4753	4-2-44
1N5576A		1N4753	4-2-44
1N5576B		1N4753A	4-2-44
1N5577		1N4754	4-2-44
1N5577A		1N4754	4-2-44
1N5577B		1N4754A	4-2-44
1N5578		1N4755	4-2-44
1N5578A		1N4755	4-2-44
1N5578B		1N4755A	4-2-44
1N5579		1N4756	4-2-44
1N5579A		1N4756	4-2-44
1N5579B		1N4756A	4-2-44
1N5580		1N4757	4-2-44
1N5580A		1N4757	4-2-44
1N5580B		1N4757A	4-2-44
1N5581		1N4758	4-2-44
1N5581A		1N4758	4-2-44
1N5581B		1N4758A	4-2-44
1N5582		1N4759	4-2-44
1N5582A		1N4759	4-2-44

CF = consult factory representative

CROSS-REFERENCE (continued)

Industry Part Number	Motorola Direct Replacement	Motorola Similar Replacement	Page Number
1N5582B		1N4759A	4-2-44
1N5583		1N4760	4-2-44
1N5583A		1N4760	4-2-44
1N5583B		1N4760A	4-2-44
1N5584		1N4761	4-2-44
1N5584A		1N4761	4-2-44
1N5584B		1N4761A	4-2-44
1N5585		1N4762	4-2-44
1N5585A		1N4762	4-2-44
1N5585B		1N4762A	4-2-44
1N5586		1N4763	4-2-44
1N5586A		1N4763	4-2-44
1N5586B		1N4763A	4-2-44
1N5587		1N4764	4-2-44
1N5587A		1N4764	4-2-44
1N5587B		1N4764A	4-2-44
1N5588		1M110ZS10	4-2-56
1N5588A		1M110ZS10	4-2-56
1N5588B		1M110ZS5	4-2-56
1N5589		1M120ZS10	4-2-56
1N5589A		1M120ZS10	4-2-56
1N5589B		1M120ZS5	4-2-56
1N5590		1M130ZS10	4-2-56
1N5590A		1M130ZS10	4-2-56
1N5590B		1M130ZS5	4-2-56
1N5591		1M150ZS10	4-2-56
1N5591A		1M150ZS10	4-2-56
1N5591B		1M150ZS5	4-2-56
1N5592		1M160ZS10	4-2-56
1N5592A		1M160ZS10	4-2-56
1N5592B		1M160ZS5	4-2-56
1N5593		1M180ZS10	4-2-56
1N5593A		1M180ZS10	4-2-56
1N5593B		1M180ZS5	4-2-56
1N5594		1M200ZS10	4-2-56
1N5594A		1M200ZS10	4-2-56
1N5594B		1M200ZS5	4-2-56
1N5610		1N6284A	4-1-43
1N5611		1N6287A	4-1-43
1N5612		1N6289A	4-1-44
1N5613		1N6303A	4-1-44
1N5629		1N6267	4-1-43
1N5629A		1N6267A	4-1-43
1N5630		1N6268	4-1-43
1N5630A		1N6268A	4-1-43
1N5631		1N6269	4-1-43
1N5631A		1N6269A	4-1-43
1N5632		1N6270	4-1-43
1N5632A		1N6270A	4-1-43
1N5633		1N6271	4-1-43
1N5633A		1N6271A	4-1-43

Industry Part Number	Motorola Direct Replacement	Motorola Similar Replacement	Page Number
1N5634		1N6272	4-1-43
1N5634A		1N6272A	4-1-43
1N5635		1N6273	4-1-43
1N5635A		1N6273A	4-1-43
1N5636		1N6274	4-1-43
1N5636A		1N6274A	4-1-43
1N5637		1N6275	4-1-43
1N5637A		1N6275A	4-1-43
1N5638		1N6276	4-1-43
1N5638A		1N6276A	4-1-43
1N5639		1N6277	4-1-43
1N5639A		1N6277A	4-1-43
1N5640		1N6278	4-1-43
1N5640A		1N6278A	4-1-43
1N5641		1N6279	4-1-43
1N5641A		1N6279A	4-1-43
1N5642		1N6280	4-1-43
1N5642A		1N6280A	4-1-43
1N5643		1N6281	4-1-43
1N5643A		1N6281A	4-1-43
1N5644		1N6282	4-1-43
1N5644A		1N6282A	4-1-43
1N5645		1N6283	4-1-43
1N5645A		1N6283A	4-1-43
1N5646		1N6284	4-1-43
1N5646A		1N6284A	4-1-43
1N5647		1N6285	4-1-43
1N5647A		1N6285A	4-1-43
1N5648		1N6286	4-1-43
1N5648A		1N6286A	4-1-43
1N5649		1N6287	4-1-43
1N5649A		1N6287A	4-1-43
1N5650		1N6288	4-1-43
1N5650A		1N6288A	4-1-43
1N5651		1N6289	4-1-44
1N5651A		1N6289A	4-1-44
1N5652		1N6290	4-1-44
1N5652A		1N6290A	4-1-44
1N5653		1N6291	4-1-44
1N5653A		1N6291A	4-1-44
1N5654		1N6292	4-1-44
1N5654A		1N6292A	4-1-44
1N5655		1N6293	4-1-44
1N5655A		1N6293A	4-1-44
1N5656		1N6294	4-1-44
1N5656A		1N6294A	4-1-44
1N5657		1N6295	4-1-44
1N5657A		1N6295A	4-1-44
1N5658		1N6296	4-1-44
1N5658A		1N6296A	4-1-44
1N5659		1N6297	4-1-44

CF = consult factory representative

CROSS-REFERENCE (continued)

Industry Part Number	Motorola Direct Replacement	Motorola Similar Replacement	Page Number
1N5659A		1N6297A	4-1-44
1N5660		1N6298	4-1-44
1N5660A		1N6298A	4-1-44
1N5661		1N6299	4-1-44
1N5661A		1N6299A	4-1-44
1N5662		1N6300	4-1-44
1N5662A		1N6300A	4-1-44
1N5663		1N6301	4-1-44
1N5663A		1N6301A	4-1-44
1N5664		1N6302	4-1-44
1N5664A		1N6302A	4-1-44
1N5665		1N6303	4-1-44
1N5665A		1N6303A	4-1-44
1N5728B		1N5992B	4-2-33
1N5728C		1N5992C	4-2-33
1N5728D		1N5992D	4-2-33
1N5729B		1N5993B	4-2-33
1N5729C		1N5993C	4-2-33
1N5729D		1N5993D	4-2-33
1N5730B		1N5994B	4-2-33
1N5730C		1N5994C	4-2-33
1N5730D		1N5994D	4-2-33
1N5731B		1N5995B	4-2-33
1N5731C		1N5995C	4-2-33
1N5731D		1N5995D	4-2-33
1N5732B		1N5996B	4-2-33
1N5732C		1N5996C	4-2-33
1N5732D		1N5996D	4-2-33
1N5733B		1N5997B	4-2-33
1N5733C		1N5997C	4-2-33
1N5733D		1N5997D	4-2-33
1N5734B		1N5998B	4-2-33
1N5734C		1N5998C	4-2-33
1N5734D		1N5998D	4-2-33
1N5735B		1N5999B	4-2-33
1N5735C		1N5999C	4-2-33
1N5735D		1N5999D	4-2-33
1N5736B		1N6000B	4-2-33
1N5736C		1N6000C	4-2-33
1N5736D		1N6000D	4-2-33
1N5737B		1N6001B	4-2-33
1N5737C		1N6001C	4-2-33
1N5737D		1N6001D	4-2-33
1N5738B		1N6002B	4-2-33
1N5738C		1N6002C	4-2-33
1N5738D		1N6002D	4-2-33
1N5739B		1N6003B	4-2-33
1N5739C		1N6003C	4-2-33
1N5739D		1N6003D	4-2-33
1N5740B		1N6004B	4-2-33
1N5740C		1N6004C	4-2-33

Industry Part Number	Motorola Direct Replacement	Motorola Similar Replacement	Page Number
1N5740D		1N6004D	4-2-33
1N5741B		1N6005B	4-2-33
1N5741C		1N6005C	4-2-33
1N5741D		1N6005D	4-2-33
1N5742B		1N6006B	4-2-33
1N5742C		1N6006C	4-2-33
1N5742D		1N6006D	4-2-33
1N5743B		1N6007B	4-2-33
1N5743C		1N6007C	4-2-33
1N5743D		1N6007D	4-2-33
1N5744B		1N6008B	4-2-33
1N5744C		1N6008C	4-2-33
1N5744D		1N6008D	4-2-33
1N5745B		1N6009B	4-2-33
1N5745C		1N6009C	4-2-33
1N5745D		1N6009D	4-2-33
1N5746B		1N6010B	4-2-33
1N5746C		1N6010C	4-2-33
1N5746D		1N6010D	4-2-33
1N5747B		1N6011B	4-2-33
1N5747C		1N6011C	4-2-33
1N5747D		1N6011D	4-2-33
1N5748B		1N6012B	4-2-33
1N5748C		1N6012C	4-2-33
1N5748D		1N6012D	4-2-33
1N5749B		1N6013B	4-2-33
1N5749C		1N6013C	4-2-33
1N5749D		1N6013D	4-2-33
1N5750B		1N6014B	4-2-33
1N5750C		1N6014C	4-2-33
1N5750D		1N6014D	4-2-33
1N5751B		1N6015B	4-2-33
1N5751C		1N6015C	4-2-33
1N5751D		1N6015D	4-2-33
1N5752B		1N6016B	4-2-33
1N5752C		1N6016C	4-2-33
1N5752D		1N6016D	4-2-33
1N5753B		1N6017B	4-2-33
1N5753C		1N6017C	4-2-33
1N5753D		1N6017D	4-2-33
1N5754B		1N6018B	4-2-33
1N5754C		1N6018C	4-2-33
1N5754D		1N6018D	4-2-33
1N5755B		1N6019B	4-2-33
1N5755C		1N6019C	4-2-33
1N5755D		1N6019D	4-2-33
1N5756B		1N6020B	4-2-33
1N5756C		1N6020C	4-2-33
1N5756D		1N6020D	4-2-33
1N5757B		1N6021B	4-2-33
1N5757C		1N6021C	4-2-33



CF = consult factory representative

CROSS-REFERENCE (continued)

2

Industry Part Number	Motorola Direct Replacement	Motorola Similar Replacement	Page Number
1N5757D		1N6021D	4-2-33
1N5837		1N5221A	4-2-31
1N5837A		1N5221A	4-2-31
1N5837B		1N5221B	4-2-31
1N5838		1N5222A	4-2-31
1N5838A		1N5222A	4-2-31
1N5838B		1N5222B	4-2-31
1N5839		1N5223A	4-2-31
1N5839A		1N5223A	4-2-31
1N5839B		1N5223B	4-2-31
1N5840		1N5224A	4-2-31
1N5840A		1N5224A	4-2-31
1N5840B		1N5224B	4-2-31
1N5841		1N5225A	4-2-31
1N5841A		1N5225A	4-2-31
1N5841B		1N5225B	4-2-31
1N5842		1N5226A	4-2-31
1N5842A		1N5226A	4-2-31
1N5842B		1N5226B	4-2-31
1N5843		1N5227A	4-2-31
1N5843A		1N5227A	4-2-31
1N5843B		1N5227B	4-2-31
1N5844		1N5228A	4-2-31
1N5844A		1N5228A	4-2-31
1N5844B		1N5228B	4-2-31
1N5845		1N5229A	4-2-31
1N5845A		1N5229A	4-2-31
1N5845B		1N5229B	4-2-31
1N5846		1N5230A	4-2-31
1N5846A		1N5230A	4-2-31
1N5846B		1N5230B	4-2-31
1N5847		1N5231A	4-2-31
1N5847A		1N5231A	4-2-31
1N5847B		1N5231B	4-2-31
1N5848		1N5232A	4-2-31
1N5848A		1N5232A	4-2-31
1N5848B		1N5232B	4-2-31
1N5849		1N5233A	4-2-31
1N5849A		1N5233A	4-2-31
1N5849B		1N5233B	4-2-31
1N5850		1N5234A	4-2-31
1N5850A		1N5234A	4-2-31
1N5850B		1N5234B	4-2-31
1N5851		1N5235A	4-2-31
1N5851A		1N5235A	4-2-31
1N5851B		1N5235B	4-2-31
1N5852		1N5236A	4-2-31
1N5852A		1N5236A	4-2-31
1N5852B		1N5236B	4-2-31
1N5853		1N5237A	4-2-31
1N5853A		1N5237A	4-2-31

Industry Part Number	Motorola Direct Replacement	Motorola Similar Replacement	Page Number
1N5853B		1N5237B	4-2-31
1N5854		1N5238A	4-2-31
1N5854A		1N5238A	4-2-31
1N5854B		1N5238B	4-2-31
1N5855		1N5239A	4-2-31
1N5855A		1N5239A	4-2-31
1N5855B		1N5239B	4-2-31
1N5856		1N5240A	4-2-31
1N5856A		1N5240A	4-2-31
1N5856B		1N5240B	4-2-31
1N5857		1N5241A	4-2-31
1N5857A		1N5241A	4-2-31
1N5857B		1N5241B	4-2-31
1N5858		1N5242A	4-2-31
1N5858A		1N5242A	4-2-31
1N5858B		1N5242B	4-2-31
1N5859		1N5243A	4-2-31
1N5859A		1N5243A	4-2-31
1N5859B		1N5243B	4-2-31
1N5860		1N5244A	4-2-31
1N5860A		1N5244A	4-2-31
1N5860B		1N5244B	4-2-31
1N5861		1N5245A	4-2-31
1N5861A		1N5245A	4-2-31
1N5861B		1N5245B	4-2-31
1N5862		1N5246A	4-2-31
1N5862A		1N5246A	4-2-31
1N5862B		1N5246B	4-2-31
1N5863		1N5247A	4-2-31
1N5863A		1N5247A	4-2-31
1N5863B		1N5247B	4-2-31
1N5864		1N5248A	4-2-31
1N5864A		1N5248A	4-2-31
1N5864B		1N5248B	4-2-31
1N5865		1N5249A	4-2-31
1N5865A		1N5249A	4-2-31
1N5865B		1N5249B	4-2-31
1N5866		1N5250A	4-2-31
1N5866A		1N5250A	4-2-31
1N5866B		1N5250B	4-2-31
1N5867		1N5251A	4-2-31
1N5867A		1N5251A	4-2-31
1N5867B		1N5251B	4-2-31
1N5868		1N5252A	4-2-31
1N5868A		1N5252A	4-2-31
1N5868B		1N5252B	4-2-31
1N5869		1N5253A	4-2-31
1N5869A		1N5253A	4-2-31
1N5869B		1N5253B	4-2-31
1N5870		1N5254A	4-2-31
1N5870A		1N5254A	4-2-31

CF = consult factory representative

CROSS-REFERENCE (continued)

Industry Part Number	Motorola Direct Replacement	Motorola Similar Replacement	Page Number
1N5870B		1N5254B	4-2-31
1N5871		1N5255A	4-2-31
1N5871A		1N5255A	4-2-31
1N5871B		1N5255B	4-2-31
1N5872		1N5256A	4-2-31
1N5872A		1N5256A	4-2-31
1N5872B		1N5256B	4-2-31
1N5873		1N5257A	4-2-31
1N5873A		1N5257A	4-2-31
1N5873B		1N5257B	4-2-31
1N5874		1N5258A	4-2-31
1N5874A		1N5258A	4-2-31
1N5874B		1N5258B	4-2-31
1N5875		1N5259A	4-2-31
1N5875A		1N5259A	4-2-31
1N5875B		1N5259B	4-2-31
1N5876		1N5260A	4-2-31
1N5876A		1N5260A	4-2-31
1N5876B		1N5260B	4-2-31
1N5877		1N5261A	4-2-31
1N5877A		1N5261A	4-2-31
1N5877B		1N5261B	4-2-31
1N5878		1N5262A	4-2-31
1N5878A		1N5262A	4-2-31
1N5878B		1N5262B	4-2-31
1N5879		1N5263A	4-2-31
1N5879A		1N5263A	4-2-31
1N5879B		1N5263B	4-2-31
1N5880		1N5264A	4-2-31
1N5880A		1N5264A	4-2-31
1N5880B		1N5264B	4-2-31
1N5881		1N5265A	4-2-31
1N5881A		1N5265A	4-2-31
1N5881B		1N5265B	4-2-31
1N5882		1N5266A	4-2-32
1N5882A		1N5266A	4-2-32
1N5882B		1N5266B	4-2-32
1N5883		1N5267A	4-2-32
1N5883A		1N5267A	4-2-32
1N5883B		1N5267B	4-2-32
1N5884		1N5268A	4-2-32
1N5884A		1N5268A	4-2-32
1N5884B		1N5268B	4-2-32
1N5885		1N5269A	4-2-32
1N5885A		1N5269A	4-2-32
1N5885B		1N5269B	4-2-32
1N5886		1N5270A	4-2-32
1N5886A		1N5270A	4-2-32
1N5886B		1N5270B	4-2-32
1N5887		1N5271A	4-2-32
1N5887A		1N5271A	4-2-32

Industry Part Number	Motorola Direct Replacement	Motorola Similar Replacement	Page Number
1N5887B		1N5271B	4-2-32
1N5888		1N5272A	4-2-32
1N5888A		1N5272A	4-2-32
1N5888B		1N5272B	4-2-32
1N5889		1N5273A	4-2-32
1N5889A		1N5273A	4-2-32
1N5889B		1N5273B	4-2-32
1N5890		1N5274A	4-2-32
1N5890A		1N5274A	4-2-32
1N5890B		1N5274B	4-2-32
1N5891		1N5275A	4-2-32
1N5891A		1N5275A	4-2-32
1N5891B		1N5275B	4-2-32
1N5892		1N5276A	4-2-32
1N5892A		1N5276A	4-2-32
1N5892B		1N5276B	4-2-32
1N5893		1N5277A	4-2-32
1N5893A		1N5277A	4-2-32
1N5893B		1N5277B	4-2-32
1N5894		1N5278A	4-2-32
1N5894A		1N5278A	4-2-32
1N5894B		1N5278B	4-2-32
1N5895		1N5279A	4-2-32
1N5895A		1N5279A	4-2-32
1N5895B		1N5279B	4-2-32
1N5896		1N5280A	4-2-32
1N5896A		1N5280A	4-2-32
1N5896B		1N5280B	4-2-32
1N5897		1N5281A	4-2-32
1N5897A		1N5281A	4-2-32
1N5897B		1N5281B	4-2-32
1N5907		1N5908	4-1-42
1N5908	1N5908		4-1-42
1N5913	1N5913A		4-2-51
1N5913A	1N5913A		4-2-51
1N5913B	1N5913B		4-2-51
1N5914	1N5914A		4-2-51
1N5914A	1N5914A		4-2-51
1N5914B	1N5914B		4-2-51
1N5915	1N5915A		4-2-51
1N5915A	1N5915A		4-2-51
1N5915B	1N5915B		4-2-51
1N5916	1N5916A		4-2-51
1N5916A	1N5916A		4-2-51
1N5916B	1N5916B		4-2-51
1N5917	1N5917A		4-2-51
1N5917A	1N5917A		4-2-51
1N5917B	1N5917B		4-2-51
1N5918	1N5918A		4-2-51
1N5918A	1N5918A		4-2-51
1N5918B	1N5918B		4-2-51



CF = consult factory representative

CROSS-REFERENCE (continued)

2

Industry Part Number	Motorola Direct Replacement	Motorola Similar Replacement	Page Number
1N5919	1N5919A		4-2-51
1N5919A	1N5919A		4-2-51
1N5919B	1N5919B		4-2-51
1N5920	1N5920A		4-2-51
1N5920A	1N5920A		4-2-51
1N5920B	1N5920B		4-2-51
1N5921	1N5921A		4-2-51
1N5921A	1N5921A		4-2-51
1N5921B	1N5921B		4-2-51
1N5922	1N5922A		4-2-51
1N5922A	1N5922A		4-2-51
1N5922B	1N5922B		4-2-51
1N5923	1N5923A		4-2-51
1N5923A	1N5923A		4-2-51
1N5923B	1N5923B		4-2-51
1N5924	1N5924A		4-2-51
1N5924A	1N5924A		4-2-51
1N5924B	1N5924B		4-2-51
1N5925	1N5925A		4-2-51
1N5925A	1N5925A		4-2-51
1N5925B	1N5925B		4-2-51
1N5926	1N5926A		4-2-51
1N5926A	1N5926A		4-2-51
1N5926B	1N5926B		4-2-51
1N5927	1N5927A		4-2-51
1N5927A	1N5927A		4-2-51
1N5927B	1N5927B		4-2-51
1N5928	1N5928A		4-2-51
1N5928A	1N5928A		4-2-51
1N5928B	1N5928B		4-2-51
1N5929	1N5929A		4-2-51
1N5929A	1N5929A		4-2-51
1N5929B	1N5929B		4-2-51
1N5930	1N5930A		4-2-51
1N5930A	1N5930A		4-2-51
1N5930B	1N5930B		4-2-51
1N5931	1N5931A		4-2-51
1N5931A	1N5931A		4-2-51
1N5931B	1N5931B		4-2-51
1N5932	1N5932A		4-2-51
1N5932A	1N5932A		4-2-51
1N5932B	1N5932B		4-2-51
1N5933	1N5933A		4-2-51
1N5933A	1N5933A		4-2-51
1N5933B	1N5933B		4-2-51
1N5934	1N5934A		4-2-51
1N5934A	1N5934A		4-2-51
1N5934B	1N5934B		4-2-51
1N5935	1N5935A		4-2-51
1N5935A	1N5935A		4-2-51
1N5935B	1N5935B		4-2-51

Industry Part Number	Motorola Direct Replacement	Motorola Similar Replacement	Page Number
1N5936	1N5936A		4-2-51
1N5936A	1N5936A		4-2-51
1N5936B	1N5936B		4-2-51
1N5937	1N5937A		4-2-51
1N5937A	1N5937A		4-2-51
1N5937B	1N5937B		4-2-51
1N5938	1N5938A		4-2-51
1N5938A	1N5938A		4-2-51
1N5938B	1N5938B		4-2-51
1N5939	1N5939A		4-2-51
1N5939A	1N5939A		4-2-51
1N5939B	1N5939B		4-2-51
1N5940	1N5940A		4-2-51
1N5940A	1N5940A		4-2-51
1N5940B	1N5940B		4-2-51
1N5941	1N5941A		4-2-51
1N5941A	1N5941A		4-2-51
1N5941B	1N5941B		4-2-51
1N5942	1N5942A		4-2-51
1N5942A	1N5942A		4-2-51
1N5942B	1N5942B		4-2-51
1N5943	1N5943A		4-2-51
1N5943A	1N5943A		4-2-51
1N5943B	1N5943B		4-2-51
1N5944	1N5944A		4-2-51
1N5944A	1N5944A		4-2-51
1N5944B	1N5944B		4-2-51
1N5945	1N5945A		4-2-51
1N5945A	1N5945A		4-2-51
1N5945B	1N5945B		4-2-51
1N5946	1N5946A		4-2-51
1N5946A	1N5946A		4-2-51
1N5946B	1N5946B		4-2-51
1N5947	1N5947A		4-2-51
1N5947A	1N5947A		4-2-51
1N5947B	1N5947B		4-2-51
1N5948	1N5948A		4-2-52
1N5948A	1N5948A		4-2-52
1N5948B	1N5948B		4-2-52
1N5949	1N5949A		4-2-52
1N5949A	1N5949A		4-2-52
1N5949B	1N5949B		4-2-52
1N5950	1N5950A		4-2-52
1N5950A	1N5950A		4-2-52
1N5950B	1N5950B		4-2-52
1N5951	1N5951A		4-2-52
1N5951A	1N5951A		4-2-52
1N5951B	1N5951B		4-2-52
1N5952	1N5952A		4-2-52
1N5952A	1N5952A		4-2-52
1N5952B	1N5952B		4-2-52

CF = consult factory representative

CROSS-REFERENCE (continued)

Industry Part Number	Motorola Direct Replacement	Motorola Similar Replacement	Page Number
1N5953	1N5953A		4-2-52
1N5953A	1N5953A		4-2-52
1N5953B	1N5953B		4-2-52
1N5954	1N5954A		4-2-52
1N5954A	1N5954A		4-2-52
1N5954B	1N5954B		4-2-52
1N5955	1N5955A		4-2-52
1N5955A	1N5955A		4-2-52
1N5955B	1N5955B		4-2-52
1N5956	1N5956A		4-2-52
1N5956A	1N5956A		4-2-52
1N5956B	1N5956B		4-2-52
1N5985	1N5985A		4-2-33
1N5985A	1N5985A		4-2-33
1N5985B	1N5985B		4-2-33
1N5985C	1N5985C		4-2-33
1N5985D	1N5985D		4-2-33
1N5986	1N5986A		4-2-33
1N5986A	1N5986A		4-2-33
1N5986B	1N5986B		4-2-33
1N5986C	1N5986C		4-2-33
1N5986D	1N5986D		4-2-33
1N5987	1N5987A		4-2-33
1N5987A	1N5987A		4-2-33
1N5987B	1N5987B		4-2-33
1N5987C	1N5987C		4-2-33
1N5987D	1N5987D		4-2-33
1N5988	1N5988A		4-2-33
1N5988A	1N5988A		4-2-33
1N5988B	1N5988B		4-2-33
1N5988C	1N5988C		4-2-33
1N5988D	1N5988D		4-2-33
1N5989	1N5989A		4-2-33
1N5989A	1N5989A		4-2-33
1N5989B	1N5989B		4-2-33
1N5989C	1N5989C		4-2-33
1N5989D	1N5989D		4-2-33
1N5990	1N5990A		4-2-33
1N5990A	1N5990A		4-2-33
1N5990B	1N5990B		4-2-33
1N5990C	1N5990C		4-2-33
1N5990D	1N5990D		4-2-33
1N5991	1N5991A		4-2-33
1N5991A	1N5991A		4-2-33
1N5991B	1N5991B		4-2-33
1N5991C	1N5991C		4-2-33
1N5991D	1N5991D		4-2-33
1N5992	1N5992A		4-2-33
1N5992A	1N5992A		4-2-33
1N5992B	1N5992B		4-2-33
1N5992C	1N5992C		4-2-33

Industry Part Number	Motorola Direct Replacement	Motorola Similar Replacement	Page Number
1N5992D	1N5992D		4-2-33
1N5993	1N5993A		4-2-33
1N5993A	1N5993A		4-2-33
1N5993B	1N5993B		4-2-33
1N5993C	1N5993C		4-2-33
1N5993D	1N5993D		4-2-33
1N5994	1N5994A		4-2-33
1N5994A	1N5994A		4-2-33
1N5994B	1N5994B		4-2-33
1N5994C	1N5994C		4-2-33
1N5994D	1N5994D		4-2-33
1N5995	1N5995A		4-2-33
1N5995A	1N5995A		4-2-33
1N5995B	1N5995B		4-2-33
1N5995C	1N5995C		4-2-33
1N5995D	1N5995D		4-2-33
1N5996	1N5996A		4-2-33
1N5996A	1N5996A		4-2-33
1N5996B	1N5996B		4-2-33
1N5996C	1N5996C		4-2-33
1N5996D	1N5996D		4-2-33
1N5997	1N5997A		4-2-33
1N5997A	1N5997A		4-2-33
1N5997B	1N5997B		4-2-33
1N5997C	1N5997C		4-2-33
1N5997D	1N5997D		4-2-33
1N5998	1N5998A		4-2-33
1N5998A	1N5998A		4-2-33
1N5998B	1N5998B		4-2-33
1N5998C	1N5998C		4-2-33
1N5998D	1N5998D		4-2-33
1N5999	1N5999A		4-2-33
1N5999A	1N5999A		4-2-33
1N5999B	1N5999B		4-2-33
1N5999C	1N5999C		4-2-33
1N5999D	1N5999D		4-2-33
1N6000	1N6000A		4-2-33
1N6000A	1N6000A		4-2-33
1N6000B	1N6000B		4-2-33
1N6000C	1N6000C		4-2-33
1N6000D	1N6000D		4-2-33
1N6001	1N6001A		4-2-33
1N6001A	1N6001A		4-2-33
1N6001B	1N6001B		4-2-33
1N6001C	1N6001C		4-2-33
1N6001D	1N6001D		4-2-33
1N6002	1N6002A		4-2-33
1N6002A	1N6002A		4-2-33
1N6002B	1N6002B		4-2-33
1N6002C	1N6002C		4-2-33
1N6002D	1N6002D		4-2-33

2

CF = consult factory representative

CROSS-REFERENCE (continued)

Industry Part Number	Motorola Direct Replacement	Motorola Similar Replacement	Page Number
1N6003	1N6003A		4-2-33
1N6003A	1N6003A		4-2-33
1N6003B	1N6003B		4-2-33
1N6003C	1N6003C		4-2-33
1N6003D	1N6003D		4-2-33
1N6004	1N6004A		4-2-33
1N6004A	1N6004A		4-2-33
1N6004B	1N6004B		4-2-33
1N6004C	1N6004C		4-2-33
1N6004D	1N6004D		4-2-33
1N6005	1N6005A		4-2-33
1N6005A	1N6005A		4-2-33
1N6005B	1N6005B		4-2-33
1N6005C	1N6005C		4-2-33
1N6005D	1N6005D		4-2-33
1N6006	1N6006A		4-2-33
1N6006A	1N6006A		4-2-33
1N6006B	1N6006B		4-2-33
1N6006C	1N6006C		4-2-33
1N6006D	1N6006D		4-2-33
1N6007	1N6007A		4-2-33
1N6007A	1N6007A		4-2-33
1N6007B	1N6007B		4-2-33
1N6007C	1N6007C		4-2-33
1N6007D	1N6007D		4-2-33
1N6008	1N6008A		4-2-33
1N6008A	1N6008A		4-2-33
1N6008B	1N6008B		4-2-33
1N6008C	1N6008C		4-2-33
1N6008D	1N6008D		4-2-33
1N6009	1N6009A		4-2-33
1N6009A	1N6009A		4-2-33
1N6009B	1N6009B		4-2-33
1N6009C	1N6009C		4-2-33
1N6009D	1N6009D		4-2-33
1N6010	1N6010A		4-2-33
1N6010A	1N6010A		4-2-33
1N6010B	1N6010B		4-2-33
1N6010C	1N6010C		4-2-33
1N6010D	1N6010D		4-2-33
1N6011	1N6011A		4-2-33
1N6011A	1N6011A		4-2-33
1N6011B	1N6011B		4-2-33
1N6011C	1N6011C		4-2-33
1N6011D	1N6011D		4-2-33
1N6012	1N6012A		4-2-33
1N6012A	1N6012A		4-2-33
1N6012B	1N6012B		4-2-33
1N6012C	1N6012C		4-2-33
1N6012D	1N6012D		4-2-33
1N6013	1N6013A		4-2-33

Industry Part Number	Motorola Direct Replacement	Motorola Similar Replacement	Page Number
1N6013A	1N6013A		4-2-33
1N6013B	1N6013B		4-2-33
1N6013C	1N6013C		4-2-33
1N6013D	1N6013D		4-2-33
1N6014	1N6014A		4-2-33
1N6014A	1N6014A		4-2-33
1N6014B	1N6014B		4-2-33
1N6014C	1N6014C		4-2-33
1N6014D	1N6014D		4-2-33
1N6015	1N6015A		4-2-33
1N6015A	1N6015A		4-2-33
1N6015B	1N6015B		4-2-33
1N6015C	1N6015C		4-2-33
1N6015D	1N6015D		4-2-33
1N6016	1N6016A		4-2-33
1N6016A	1N6016A		4-2-33
1N6016B	1N6016B		4-2-33
1N6016C	1N6016C		4-2-33
1N6016D	1N6016D		4-2-33
1N6017	1N6017A		4-2-33
1N6017A	1N6017A		4-2-33
1N6017B	1N6017B		4-2-33
1N6017C	1N6017C		4-2-33
1N6017D	1N6017D		4-2-33
1N6018	1N6018A		4-2-33
1N6018A	1N6018A		4-2-33
1N6018B	1N6018B		4-2-33
1N6018C	1N6018C		4-2-33
1N6018D	1N6018D		4-2-33
1N6019	1N6019A		4-2-33
1N6019A	1N6019A		4-2-33
1N6019B	1N6019B		4-2-33
1N6019C	1N6019C		4-2-33
1N6019D	1N6019D		4-2-33
1N6020	1N6020A		4-2-33
1N6020A	1N6020A		4-2-33
1N6020B	1N6020B		4-2-33
1N6020C	1N6020C		4-2-33
1N6020D	1N6020D		4-2-33
1N6021	1N6021A		4-2-33
1N6021A	1N6021A		4-2-33
1N6021B	1N6021B		4-2-33
1N6021C	1N6021C		4-2-33
1N6021D	1N6021D		4-2-33
1N6022	1N6022A		4-2-33
1N6022A	1N6022A		4-2-33
1N6022B	1N6022B		4-2-33
1N6022C	1N6022C		4-2-33
1N6022D	1N6022D		4-2-33
1N6023	1N6023A		4-2-33
1N6023A	1N6023A		4-2-33

CF = consult factory representative

CROSS-REFERENCE (continued)

Industry Part Number	Motorola Direct Replacement	Motorola Similar Replacement	Page Number
1N6023B	1N6023B		4-2-33
1N6023C	1N6023C		4-2-33
1N6023D	1N6023D		4-2-33
1N6024	1N6024A		4-2-33
1N6024A	1N6024A		4-2-33
1N6024B	1N6024B		4-2-33
1N6024C	1N6024C		4-2-33
1N6024D	1N6024D		4-2-33
1N6025	1N6025A		4-2-33
1N6025A	1N6025A		4-2-33
1N6025B	1N6025B		4-2-33
1N6025C	1N6025C		4-2-33
1N6025D	1N6025D		4-2-33
1N6026		1N5273A	4-2-32
1N6026A		1N5273A	4-2-32
1N6026B		1N5273B	4-2-32
1N6027		1N5274A	4-2-32
1N6027A		1N5274A	4-2-32
1N6027B		1N5274B	4-2-32
1N6028		1N5276A	4-2-32
1N6028A		1N5276A	4-2-32
1N6028B		1N5276B	4-2-32
1N6029		1N5277A	4-2-32
1N6029A		1N5277A	4-2-32
1N6029B		1N5277B	4-2-32
1N6030		1N5279A	4-2-32
1N6030A		1N5279A	4-2-32
1N6030B		1N5279B	4-2-32
1N6031		1N5281A	4-2-32
1N6031A		1N5281A	4-2-32
1N6031B		1N5281B	4-2-32
1N6036		1.5KE7.5C	4-1-43
1N6036A		1.5KE7.5CA	4-1-43
1N6037		1.5KE8.2C	4-1-43
1N6037A		1.5KE8.2CA	4-1-43
1N6038		1.5KE9.1C	4-1-43
1N6038A		1.5KE9.1CA	4-1-43
1N6039		1.5KE10C	4-1-43
1N6039A		1.5KE10CA	4-1-43
1N6040		1.5KE11C	4-1-43
1N6040A		1.5KE11CA	4-1-43
1N6041		1.5KE12C	4-1-43
1N6041A		1.5KE12CA	4-1-43
1N6042		1.5KE13C	4-1-43
1N6042A		1.5KE13CA	4-1-43
1N6043		1.5KE15C	4-1-43
1N6043A		1.5KE15CA	4-1-43
1N6044		1.5KE16C	4-1-43
1N6044A		1.5KE16CA	4-1-43
1N6045		1.5KE18C	4-1-43
1N6045A		1.5KE18CA	4-1-43

Industry Part Number	Motorola Direct Replacement	Motorola Similar Replacement	Page Number
1N6046		1.5KE20C	4-1-43
1N6046A		1.5KE20CA	4-1-43
1N6047		1.5KE22C	4-1-43
1N6047A		1.5KE22CA	4-1-43
1N6048		1.5KE24C	4-1-43
1N6048A		1.5KE24CA	4-1-43
1N6049		1.5KE27C	4-1-43
1N6049A		1.5KE27CA	4-1-43
1N6050		1.5KE30C	4-1-43
1N6050A		1.5KE30CA	4-1-43
1N6051		1.5KE33C	4-1-43
1N6051A		1.5KE33CA	4-1-43
1N6052		1.5KE36C	4-1-43
1N6052A		1.5KE36CA	4-1-43
1N6053		1.5KE39C	4-1-43
1N6053A		1.5KE39CA	4-1-43
1N6054		1.5KE43C	4-1-43
1N6054A		1.5KE43CA	4-1-43
1N6055		1.5KE47C	4-1-43
1N6055A		1.5KE47CA	4-1-43
1N6056		1.5KE51C	4-1-43
1N6056A		1.5KE51CA	4-1-43
1N6057		1.5KE56C	4-1-44
1N6057A		1.5KE56CA	4-1-44
1N6058		1.5KE62C	4-1-44
1N6058A		1.5KE62CA	4-1-44
1N6059		1.5KE68C	4-1-44
1N6059A		1.5KE68CA	4-1-44
1N6060		1.5KE75C	4-1-44
1N6060A		1.5KE75CA	4-1-44
1N6061		1.5KE82C	4-1-44
1N6061A		1.5KE82CA	4-1-44
1N6062		1.5KE91C	4-1-44
1N6062A		1.5KE91CA	4-1-44
1N6063		1.5KE100C	4-1-44
1N6063A		1.5KE100CA	4-1-44
1N6064		1.5KE110C	4-1-44
1N6064A		1.5KE110CA	4-1-44
1N6065		1.5KE120C	4-1-44
1N6065A		1.5KE120CA	4-1-44
1N6066		1.5KE130C	4-1-44
1N6066A		1.5KE130CA	4-1-44
1N6067		1.5KE150C	4-1-44
1N6067A		1.5KE150CA	4-1-44
1N6068		1.5KE170C	4-1-44
1N6068A		1.5KE170CA	4-1-44
1N6069		1.5KE180C	4-1-44
1N6069A		1.5KE180CA	4-1-44
1N6070		1.5KE200CA	4-1-44
1N6070A		1.5KE200CA	4-1-44
1N6071		1.5KE200C	4-1-44



CF = consult factory representative

CROSS-REFERENCE (continued)

Industry Part Number	Motorola Direct Replacement	Motorola Similar Replacement	Page Number
1N6071A		1.5KE200CA	4-1-44
1N6072		1.5KE220C	4-1-44
1N6072A		1.5KE220CA	4-1-44
1N6082		MZ5521B	4-2-38
1N6083		MZ5522B	4-2-38
1N6084		MZ5523B	4-2-38
1N6085		MZ5524B	4-2-38
1N6086		MZ5525B	4-2-38
1N6087		MZ5526B	4-2-38
1N6088		MZ5527B	4-2-38
1N6089		MZ5528B	4-2-38
1N6090		MZ5529B	4-2-38
1N6091		MZ5530B	4-2-38
1N6102A		SA6.0CA	4-1-26
1N6103A		SA6.5CA	4-1-26
1N6104A		SA7.0CA	4-1-26
1N6105A		SA7.5CA	4-1-26
1N6106A		SA8.5CA	4-1-26
1N6107A		SA9.0CA	4-1-26
1N6108A		SA10CA	4-1-26
1N6109A		SA11CA	4-1-26
1N6110A		SA12CA	4-1-26
1N6111A		SA13CA	4-1-26
1N6112A		SA15CA	4-1-26
1N6113A		SA17CA	4-1-26
1N6114A		SA18CA	4-1-26
1N6115A		SA20CA	4-1-26
1N6116A		SA22CA	4-1-26
1N6117A		SA24CA	4-1-26
1N6118A		SA28CA	4-1-26
1N6119A		SA30CA	4-1-26
1N6120A		SA33CA	4-1-26
1N6121A		SA36CA	4-1-27
1N6122A		SA40CA	4-1-27
1N6123A		SA43CA	4-1-27
1N6124A		SA48CA	4-1-27
1N6125A		SA51CA	4-1-27
1N6126A		SA58CA	4-1-27
1N6127A		SA64CA	4-1-27
1N6128A		SA70CA	4-1-27
1N6129A		SA75CA	4-1-27
1N6130A		SA85CA	4-1-27
1N6131A		SA90CA	4-1-27
1N6132A		SA100CA	4-1-27
1N6133A		SA110CA	4-1-27
1N6134A		SA120CA	4-1-27
1N6135A		SA130CA	4-1-27
1N6136A		SA150CA	4-1-27
1N6137A		SA170CA	4-1-27
1N6138A		1.5KE6.8CA	4-1-43
1N6139A		1.5KE7.5CA	4-1-43

Industry Part Number	Motorola Direct Replacement	Motorola Similar Replacement	Page Number
1N6140A		1.5KE8.2CA	4-1-43
1N6141A		1.5KE9.1CA	4-1-43
1N6142A		1.5KE10CA	4-1-43
1N6143A		1.5KE11CA	4-1-43
1N6144A		1.5KE12CA	4-1-43
1N6145A		1.5KE13CA	4-1-43
1N6146A		1.5KE15CA	4-1-43
1N6147A		1.5KE16CA	4-1-43
1N6148A		1.5KE18CA	4-1-43
1N6149A		1.5KE20CA	4-1-43
1N6150A		1.5KE22CA	4-1-43
1N6151A		1.5KE24CA	4-1-43
1N6152A		1.5KE27CA	4-1-43
1N6153A		1.5KE30CA	4-1-43
1N6154A		1.5KE33CA	4-1-43
1N6155A		1.5KE36CA	4-1-43
1N6156A		1.5KE39CA	4-1-43
1N6157A		1.5KE43CA	4-1-43
1N6158A		1.5KE47CA	4-1-43
1N6159A		1.5KE51CA	4-1-43
1N6160A		1.5KE56CA	4-1-44
1N6161A		1.5KE62CA	4-1-44
1N6162A		1.5KE68CA	4-1-44
1N6163A		1.5KE75CA	4-1-44
1N6164A		1.5KE82CA	4-1-44
1N6165A		1.5KE91CA	4-1-44
1N6166A		1.5KE100CA	4-1-44
1N6167A		1.5KE110CA	4-1-44
1N6168A		1.5KE120CA	4-1-44
1N6169A		1.5KE130CA	4-1-44
1N6170A		1.5KE150CA	4-1-44
1N6171A		1.5KE160CA	4-1-44
1N6172A		1.5KE180CA	4-1-44
1N6173A		1.5KE200CA	4-1-44
1N6267	1N6267		4-1-43
1N6267A	1N6267A		4-1-43
1N6268	1N6268		4-1-43
1N6268A	1N6268A		4-1-43
1N6269	1N6269		4-1-43
1N6269A	1N6269A		4-1-43
1N6270	1N6270		4-1-43
1N6270A	1N6270A		4-1-43
1N6271	1N6271		4-1-43
1N6271A	1N6271A		4-1-43
1N6272	1N6272		4-1-43
1N6272A	1N6272A		4-1-43
1N6273	1N6273		4-1-43
1N6273A	1N6273A		4-1-43
1N6274	1N6274		4-1-43
1N6274A	1N6274A		4-1-43
1N6275	1N6275		4-1-43

CF = consult factory representative

CROSS-REFERENCE (continued)

Industry Part Number	Motorola Direct Replacement	Motorola Similar Replacement	Page Number	Industry Part Number	Motorola Direct Replacement	Motorola Similar Replacement	Page Number
1N6275A	1N6275A		4-1-43	1N6301	1N6301		4-1-44
1N6276	1N6276		4-1-43	1N6301A	1N6301A		4-1-44
1N6276A	1N6276A		4-1-43	1N6302	1N6302		4-1-44
1N6277	1N6277		4-1-43	1N6302A	1N6302A		4-1-44
1N6277A	1N6277A		4-1-43	1N6303	1N6303		4-1-44
1N6278	1N6278		4-1-43	1N6303A	1N6303A		4-1-44
1N6278A	1N6278A		4-1-43	1N6356		1N6373	4-1-46
1N6279	1N6279		4-1-43	1N6357		1N6374	4-1-46
1N6279A	1N6279A		4-1-43	1N6358		1N6375	4-1-46
1N6280	1N6280		4-1-43	1N6359		1N6376	4-1-46
1N6280A	1N6280A		4-1-43	1N6360		1N6377	4-1-46
1N6281	1N6281		4-1-43	1N6361		1N6378	4-1-46
1N6281A	1N6281A		4-1-43	1N6362		1N6379	4-1-46
1N6282	1N6282		4-1-43	1N6363		1N6380	4-1-46
1N6282A	1N6282A		4-1-43	1N6364		1N6381	4-1-46
1N6283	1N6283		4-1-43	1N6365		1N6382	4-1-46
1N6283A	1N6283A		4-1-43	1N6366		1N6383	4-1-46
1N6284	1N6284		4-1-43	1N6367		1N6384	4-1-46
1N6284A	1N6284A		4-1-43	1N6368		1N6385	4-1-46
1N6285	1N6285		4-1-43	1N6369		1N6386	4-1-46
1N6285A	1N6285A		4-1-43	1N6370		1N6387	4-1-46
1N6286	1N6286		4-1-43	1N6371		1N6388	4-1-46
1N6286A	1N6286A		4-1-43	1N6372		1N6389	4-1-46
1N6287	1N6287		4-1-43	1N6373	1N6373		4-1-46
1N6287A	1N6287A		4-1-43	1N6374	1N6374		4-1-46
1N6288	1N6288		4-1-43	1N6375	1N6375		4-1-46
1N6288A	1N6288A		4-1-43	1N6376	1N6376		4-1-46
1N6289	1N6289		4-1-44	1N6377	1N6377		4-1-46
1N6289A	1N6289A		4-1-44	1N6378	1N6378		4-1-46
1N6290	1N6290		4-1-44	1N6379	1N6379		4-1-46
1N6290A	1N6290A		4-1-44	1N6380	1N6380		4-1-46
1N6291	1N6291		4-1-44	1N6381	1N6381		4-1-46
1N6291A	1N6291A		4-1-44	1N6382	1N6382		4-1-46
1N6292	1N6292		4-1-44	1N6383	1N6383		4-1-46
1N6292A	1N6292A		4-1-44	1N6384	1N6384		4-1-46
1N6293	1N6293		4-1-44	1N6385	1N6385		4-1-46
1N6293A	1N6293A		4-1-44	1N6386	1N6386		4-1-46
1N6294	1N6294		4-1-44	1N6387	1N6387		4-1-46
1N6294A	1N6294A		4-1-44	1N6388	1N6388		4-1-46
1N6295	1N6295		4-1-44	1N6389	1N6389		4-1-46
1N6295A	1N6295A		4-1-44	1N6402		P6KE6.8A	4-1-33
1N6296	1N6296		4-1-44	1N6402A		P6KE6.8A	4-1-33
1N6296A	1N6296A		4-1-44	1N6403		P6KE7.5A	4-1-33
1N6297	1N6297		4-1-44	1N6403A		P6KE7.5A	4-1-33
1N6297A	1N6297A		4-1-44	1N6404		P6KE7.5A	4-1-33
1N6298	1N6298		4-1-44	1N6404A		P6KE7.5A	4-1-33
1N6298A	1N6298A		4-1-44	1N6405		P6KE8.2A	4-1-33
1N6299	1N6299		4-1-44	1N6405A		P6KE8.2A	4-1-33
1N6299A	1N6299A		4-1-44	1N6406		P6KE9.1A	4-1-33
1N6300	1N6300		4-1-44	1N6406A		P6KE9.1A	4-1-33
1N6300A	1N6300A		4-1-44	1N6407		P6KE10A	4-1-33

CF = consult factory representative



CROSS-REFERENCE (continued)

Industry Part Number	Motorola Direct Replacement	Motorola Similar Replacement	Page Number
1N6407A		P6KE10A	4-1-33
1N6408		P6KE10A	4-1-33
1N6408A		P6KE10A	4-1-33
1N6409		P6KE11A	4-1-33
1N6409A		P6KE11A	4-1-33
1N6410		P6KE12A	4-1-33
1N6410A		P6KE12A	4-1-33
1N6411		P6KE13A	4-1-33
1N6411A		P6KE13A	4-1-33
1N6412		P6KE15A	4-1-33
1N6412A		P6KE15A	4-1-33
1N6413		P6KE15A	4-1-33
1N6413A		P6KE15A	4-1-33
1N6414		P6KE18A	4-1-33
1N6414A		P6KE18A	4-1-33
1N6415		P6KE18A	4-1-33
1N6415A		P6KE18A	4-1-33
1N6416		P6KE20A	4-1-33
1N6416A		P6KE20A	4-1-33
1N6417		P6KE20A	4-1-33
1N6417A		P6KE20A	4-1-33
1N6418		P6KE22A	4-1-33
1N6418A		P6KE22A	4-1-33
1N6419		P6KE24A	4-1-33
1N6419A		P6KE24A	4-1-33
1N6420		P6KE27A	4-1-33
1N6420A		P6KE27A	4-1-33
1N6421		P6KE30A	4-1-33
1N6421A		P6KE30A	4-1-33
1N6422		P6KE33A	4-1-33
1N6422A		P6KE33A	4-1-33
1N6423		P6KE33A	4-1-33
1N6423A		P6KE33A	4-1-33
1N6424		P6KE36A	4-1-33
1N6424A		P6KE36A	4-1-33
1N6425		P6KE39A	4-1-33
1N6425A		P6KE39A	4-1-33
1N6426		P6KE43A	4-1-33
1N6426A		P6KE43A	4-1-33
1N6427		P6KE47A	4-1-33
1N6427A		P6KE47A	4-1-33
1N6428		P6KE51A	4-1-33
1N6428A		P6KE51A	4-1-33
1N6429		P6KE56A	4-1-33
1N6429A		P6KE56A	4-1-33
1N6430		P6KE56A	4-1-33
1N6430A		P6KE56A	4-1-33
1N6431		P6KE62A	4-1-33
1N6431A		P6KE62A	4-1-33
1N6432		P6KE68A	4-1-34
1N6432A		P6KE68A	4-1-34

Industry Part Number	Motorola Direct Replacement	Motorola Similar Replacement	Page Number
1N6433		P6KE68A	4-1-34
1N6433A		P6KE68A	4-1-34
1N6434		P6KE75A	4-1-34
1N6434A		P6KE75A	4-1-34
1N6435		P6KE75A	4-1-34
1N6435A		P6KE75A	4-1-34
1N6436		P6KE82A	4-1-34
1N6436A		P6KE82A	4-1-34
1N6437		P6KE91A	4-1-34
1N6437A		P6KE91A	4-1-34
1N6438		P6KE91A	4-1-34
1N6438A		P6KE91A	4-1-34
1N6439		P6KE100A	4-1-34
1N6439A		P6KE100A	4-1-34
1N6440		P6KE110A	4-1-34
1N6440A		P6KE110A	4-1-34
1N6441		P6KE120A	4-1-34
1N6441A		P6KE120A	4-1-34
1N6442		P6KE130A	4-1-34
1N6442A		P6KE130A	4-1-34
1N6443		P6KE150A	4-1-34
1N6443A		P6KE150A	4-1-34
1N6444		P6KE160A	4-1-34
1N6444A		P6KE160A	4-1-34
1N6445		P6KE180A	4-1-34
1N6445A		P6KE180A	4-1-34
1N6446		P6KE200A	4-1-34
1N6446A		P6KE200A	4-1-34
1N6447		P6KE200A	4-1-34
1N6447A		P6KE200A	4-1-34
1N6448		1.5KE220A	4-1-44
1N6448A		1.5KE220A	4-1-44
1N6449		1.5KE250A	4-1-44
1N6449A		1.5KE250A	4-1-44
1N6450		1.5KE250A	4-1-44
1N6450A		1.5KE250A	4-1-44
1N6461		SA5.0A	4-1-26
1N6462		SA6.0A	4-1-26
1N6463		SA12A	4-1-26
1N6464		SA15A	4-1-26
1N6465		SA24A	4-1-26
1N6466		SA30A	4-1-26
1N6467		SA40A	4-1-27
1N6468		SA51A	4-1-27
1N6469		1N6373	4-1-46
1N6470		1N6268A	4-1-43
1N6471		1N6384	4-1-46
1N6472		1N6385	4-1-46
1N6473		1N6282A	4-1-43
1N6474		1N6284A	4-1-43
1N6475		1N6287A	4-1-43

CF = consult factory representative

CROSS-REFERENCE (continued)

Industry Part Number	Motorola Direct Replacement	Motorola Similar Replacement	Page Number
1N6476		1N6290A	4-1-44
1N664		1N5237A	4-2-31
1N665		1N5242A	4-2-31
1N666		1N5245B	4-2-31
1N667		1N5248A	4-2-31
1N668		1N5251A	4-2-31
1N669		1N5254A	4-2-31
1N670		1N5266B	4-2-32
1N671		1N5271A	4-2-32
1N672		1N5276A	4-2-32
1N674		1N5230A	4-2-31
1N675		1N5234B	4-2-31
1N702		1N5986A	4-2-33
1N702A		1N5986D	4-2-33
1N703		1N5989B	4-2-33
1N703A		1N5989C	4-2-33
1N704		1N5990B	4-2-33
1N704A		1N5990D	4-2-33
1N705		1N5992B	4-2-33
1N705A		1N5992D	4-2-33
1N706		1N5994B	4-2-33
1N706A		1N5994D	4-2-33
1N707		1N5996B	4-2-33
1N707A		1N5996D	4-2-33
1N708A		1N5232B	4-2-31
1N709A		1N5234B	4-2-31
1N710A		1N5235B	4-2-31
1N711A		1N5236B	4-2-31
1N712A		1N5237B	4-2-31
1N713A		1N5239B	4-2-31
1N714A		1N5240B	4-2-31
1N715A		1N5241B	4-2-31
1N716A		1N5242B	4-2-31
1N717A		1N5243B	4-2-31
1N718A		1N5245B	4-2-31
1N719A		1N5246B	4-2-31
1N720A		1N5248B	4-2-31
1N721A		1N5250B	4-2-31
1N722A		1N5251B	4-2-31
1N723A		1N5252B	4-2-31
1N724A		1N5254B	4-2-31
1N725A		1N5256B	4-2-31
1N726A		1N5257B	4-2-31
1N727A		1N5258B	4-2-31
1N728A		1N5259B	4-2-31
1N729A		1N5260B	4-2-31
1N730A		1N5261B	4-2-31
1N731A		1N5262B	4-2-31
1N732A		1N5263B	4-2-31
1N733A		1N5265B	4-2-31
1N734A		1N5266B	4-2-32

Industry Part Number	Motorola Direct Replacement	Motorola Similar Replacement	Page Number
1N735A		1N5267B	4-2-32
1N736A		1N5268B	4-2-32
1N737A		1N5270B	4-2-32
1N738A		1N5271B	4-2-32
1N739A		1N5272B	4-2-32
1N740A		1N5273B	4-2-32
1N741A		1N5274B	4-2-32
1N742A		1N5276B	4-2-32
1N743A		1N5277B	4-2-32
1N744A		1N5279B	4-2-32
1N745A		1N5281B	4-2-32
1N746	1N746		4-2-28
1N746A	1N746A		4-2-28
1N746C	1N746C		4-2-28
1N746D	1N746D		4-2-28
1N747	1N747		4-2-28
1N747A	1N747A		4-2-28
1N747C	1N747C		4-2-28
1N747D	1N747D		4-2-28
1N748	1N748		4-2-28
1N748A	1N748A		4-2-28
1N748C	1N748C		4-2-28
1N748D	1N748D		4-2-28
1N749	1N749		4-2-28
1N749A	1N749A		4-2-28
1N749C	1N749C		4-2-28
1N749D	1N749D		4-2-28
1N750	1N750		4-2-28
1N750A	1N750A		4-2-28
1N750C	1N750C		4-2-28
1N750D	1N750D		4-2-28
1N751	1N751		4-2-28
1N751A	1N751A		4-2-28
1N751C	1N751C		4-2-28
1N751D	1N751D		4-2-28
1N752	1N752		4-2-28
1N752A	1N752A		4-2-28
1N752C	1N752C		4-2-28
1N752D	1N752D		4-2-28
1N753	1N753		4-2-28
1N753A	1N753A		4-2-28
1N753C	1N753C		4-2-28
1N753D	1N753D		4-2-28
1N754	1N754		4-2-28
1N754A	1N754A		4-2-28
1N754C	1N754C		4-2-28
1N754D	1N754D		4-2-28
1N755	1N755		4-2-28
1N755A	1N755A		4-2-28
1N755C	1N755C		4-2-28
1N755D	1N755D		4-2-28



CF = consult factory representative

CROSS-REFERENCE (continued)

2

Industry Part Number	Motorola Direct Replacement	Motorola Similar Replacement	Page Number
1N756	1N756		4-2-28
1N756A	1N756A		4-2-28
1N756C	1N756C		4-2-28
1N756D	1N756D		4-2-28
1N757	1N757		4-2-28
1N757A	1N757A		4-2-28
1N757C	1N757C		4-2-28
1N757D	1N757D		4-2-28
1N758	1N758		4-2-28
1N758A	1N758A		4-2-28
1N758C	1N758C		4-2-28
1N758D	1N758D		4-2-28
1N759	1N759		4-2-28
1N759A	1N759A		4-2-28
1N759C	1N759C		4-2-28
1N759D	1N759D		4-2-28
1N761		1N5231B	4-2-31
1N761A		1N5231B	4-2-31
1N762		1N5233B	4-2-31
1N762A		1N5233C	4-2-31
1N763		1N5235B	4-2-31
1N763A		1N5235D	4-2-31
1N764		1N5239B	4-2-31
1N764A		1N5239B	4-2-31
1N765		1N6001B	4-2-33
1N765A		1N6001B	4-2-33
1N766		1N6003B	4-2-33
1N766A		1N6003B	4-2-33
1N767		1N6005B	4-2-33
1N767A		1N6005B	4-2-33
1N768		1N5249B	4-2-31
1N768A		1N5249C	4-2-31
1N769		1N6009B	4-2-33
1N769A		1N6009B	4-2-33
1N821	1N821		4-3-10
1N821A	1N821A		4-3-10
1N823	1N823		4-3-10
1N823A	1N823A		4-3-10
1N825	1N825		4-3-10
1N825A	1N825A		4-3-10
1N827	1N827		4-3-10
1N827A	1N827A		4-3-10
1N829	1N829		4-3-10
1N829A	1N829A		4-3-10
1N957	1N957A		4-2-28
1N957A	1N957A		4-2-28
1N957B	1N957B		4-2-28
1N957C	1N957C		4-2-28
1N957D	1N957D		4-2-28
1N958	1N958A		4-2-28
1N958A	1N958A		4-2-28

Industry Part Number	Motorola Direct Replacement	Motorola Similar Replacement	Page Number
1N958B	1N958B		4-2-28
1N958C	1N958C		4-2-28
1N958D	1N958D		4-2-28
1N959	1N959A		4-2-28
1N959A	1N959A		4-2-28
1N959B	1N959B		4-2-28
1N959C	1N959C		4-2-28
1N959D	1N959D		4-2-28
1N960	1N960A		4-2-28
1N960A	1N960A		4-2-28
1N960B	1N960B		4-2-28
1N960C	1N960C		4-2-28
1N960D	1N960D		4-2-28
1N961	1N961A		4-2-28
1N961A	1N961A		4-2-28
1N961B	1N961B		4-2-28
1N961C	1N961C		4-2-28
1N961D	1N961D		4-2-28
1N962	1N962A		4-2-28
1N962A	1N962A		4-2-28
1N962B	1N962B		4-2-28
1N962C	1N962C		4-2-28
1N962D	1N962D		4-2-28
1N963	1N963A		4-2-28
1N963A	1N963A		4-2-28
1N963B	1N963B		4-2-28
1N963C	1N963C		4-2-28
1N963D	1N963D		4-2-28
1N964	1N964A		4-2-28
1N964A	1N964A		4-2-28
1N964B	1N964B		4-2-28
1N964C	1N964C		4-2-28
1N964D	1N964D		4-2-28
1N965	1N965A		4-2-28
1N965A	1N965A		4-2-28
1N965B	1N965B		4-2-28
1N965C	1N965C		4-2-28
1N965D	1N965D		4-2-28
1N966	1N966A		4-2-28
1N966A	1N966A		4-2-28
1N966B	1N966B		4-2-28
1N966C	1N966C		4-2-28
1N966D	1N966D		4-2-28
1N967	1N967A		4-2-28
1N967A	1N967A		4-2-28
1N967B	1N967B		4-2-28
1N967C	1N967C		4-2-28
1N967D	1N967D		4-2-28
1N968	1N968A		4-2-28
1N968A	1N968A		4-2-28
1N968B	1N968B		4-2-28

CF = consult factory representative

CROSS-REFERENCE (continued)

Industry Part Number	Motorola Direct Replacement	Motorola Similar Replacement	Page Number	Industry Part Number	Motorola Direct Replacement	Motorola Similar Replacement	Page Number
1N968C	1N968C		4-2-28	1N978D	1N978D		4-2-28
1N968D	1N968D		4-2-28	1N979	1N979A		4-2-28
1N969	1N969A		4-2-28	1N979A	1N979A		4-2-28
1N969A	1N969A		4-2-28	1N979B	1N979B		4-2-28
1N969B	1N969B		4-2-28	1N979C	1N979C		4-2-28
1N969C	1N969C		4-2-28	1N979D	1N979D		4-2-28
1N969D	1N969D		4-2-28	1N980	1N980A		4-2-28
1N970	1N970A		4-2-28	1N980A	1N980A		4-2-28
1N970A	1N970A		4-2-28	1N980B	1N980B		4-2-28
1N970B	1N970B		4-2-28	1N980C	1N980C		4-2-28
1N970C	1N970C		4-2-28	1N980D	1N980D		4-2-28
1N970D	1N970D		4-2-28	1N981	1N981A		4-2-29
1N971	1N971A		4-2-28	1N981A	1N981A		4-2-29
1N971A	1N971A		4-2-28	1N981B	1N981B		4-2-29
1N971B	1N971B		4-2-28	1N981C	1N981C		4-2-29
1N971C	1N971C		4-2-28	1N981D	1N981D		4-2-29
1N971D	1N971D		4-2-28	1N982	1N982A		4-2-29
1N972	1N972A		4-2-28	1N982A	1N982A		4-2-29
1N972A	1N972A		4-2-28	1N982B	1N982B		4-2-29
1N972B	1N972B		4-2-28	1N982C	1N982C		4-2-29
1N972C	1N972C		4-2-28	1N982D	1N982D		4-2-29
1N972D	1N972D		4-2-28	1N983	1N983A		4-2-29
1N973	1N973A		4-2-28	1N983A	1N983A		4-2-29
1N973A	1N973A		4-2-28	1N983B	1N983B		4-2-29
1N973B	1N973B		4-2-28	1N983C	1N983C		4-2-29
1N973C	1N973C		4-2-28	1N983D	1N983D		4-2-29
1N973D	1N973D		4-2-28	1N984	1N984A		4-2-29
1N974	1N974A		4-2-28	1N984A	1N984A		4-2-29
1N974A	1N974A		4-2-28	1N984B	1N984B		4-2-29
1N974B	1N974B		4-2-28	1N984C	1N984C		4-2-29
1N974C	1N974C		4-2-28	1N984D	1N984D		4-2-29
1N974D	1N974D		4-2-28	1N985	1N985A		4-2-29
1N975	1N975A		4-2-28	1N985A	1N985A		4-2-29
1N975A	1N975A		4-2-28	1N985B	1N985B		4-2-29
1N975B	1N975B		4-2-28	1N985C	1N985C		4-2-29
1N975C	1N975C		4-2-28	1N985D	1N985D		4-2-29
1N975D	1N975D		4-2-28	1N986	1N986A		4-2-29
1N976	1N976A		4-2-28	1N986A	1N986A		4-2-29
1N976A	1N976A		4-2-28	1N986B	1N986B		4-2-29
1N976B	1N976B		4-2-28	1N986C	1N986C		4-2-29
1N976C	1N976C		4-2-28	1N986D	1N986D		4-2-29
1N976D	1N976D		4-2-28	1N987	1N987A		4-2-29
1N977	1N977A		4-2-28	1N987A	1N987A		4-2-29
1N977A	1N977A		4-2-28	1N987B	1N987B		4-2-29
1N977B	1N977B		4-2-28	1N987C	1N987C		4-2-29
1N977C	1N977C		4-2-28	1N987D	1N987D		4-2-29
1N977D	1N977D		4-2-28	1N988	1N988A		4-2-29
1N978	1N978A		4-2-28	1N988A	1N988A		4-2-29
1N978A	1N978A		4-2-28	1N988B	1N988B		4-2-29
1N978B	1N978B		4-2-28	1N988C	1N988C		4-2-29
1N978C	1N978C		4-2-28	1N988D	1N988D		4-2-29

CF = consult factory representative



CROSS-REFERENCE (continued)

Industry Part Number	Motorola Direct Replacement	Motorola Similar Replacement	Page Number
1N989	1N989A		4-2-29
1N989A	1N989A		4-2-29
1N989B	1N989B		4-2-29
1N989C	1N989C		4-2-29
1N989D	1N989D		4-2-29
1N990	1N990A		4-2-29
1N990A	1N990A		4-2-29
1N990B	1N990B		4-2-29
1N990C	1N990C		4-2-29
1N990D	1N990D		4-2-29
1N991	1N991A		4-2-29
1N991A	1N991A		4-2-29
1N991B	1N991B		4-2-29
1N991C	1N991C		4-2-29
1N991D	1N991D		4-2-29
1N992	1N992A		4-2-29
1N992A	1N992A		4-2-29
1N992B	1N992B		4-2-29
1N992C	1N992C		4-2-29
1N992D	1N992D		4-2-29
1SMB100AT3	1SMB100AT3		4-1-59
1SMB10AT3	1SMB10AT3		4-1-59
1SMB110AT3	1SMB110AT3		4-1-59
1SMB11AT3	1SMB11AT3		4-1-59
1SMB120AT3	1SMB120AT3		4-1-59
1SMB12AT3	1SMB12AT3		4-1-59
1SMB130AT3	1SMB130AT3		4-1-59
1SMB13AT3	1SMB13AT3		4-1-59
1SMB14AT3	1SMB14AT3		4-1-59
1SMB150AT3	1SMB150AT3		4-1-59
1SMB15AT3	1SMB15AT3		4-1-59
1SMB160AT3	1SMB160AT3		4-1-59
1SMB16AT3	1SMB16AT3		4-1-59
1SMB170AT3	1SMB170AT3		4-1-59
1SMB17AT3	1SMB17AT3		4-1-59
1SMB18AT3	1SMB18AT3		4-1-59
1SMB20AT3	1SMB20AT3		4-1-59
1SMB22AT3	1SMB22AT3		4-1-59
1SMB24AT3	1SMB24AT3		4-1-59
1SMB26AT3	1SMB26AT3		4-1-59
1SMB28AT3	1SMB28AT3		4-1-59
1SMB30AT3	1SMB30AT3		4-1-59
1SMB33AT3	1SMB33AT3		4-1-59
1SMB36AT3	1SMB36AT3		4-1-59
1SMB40AT3	1SMB40AT3		4-1-59
1SMB43AT3	1SMB43AT3		4-1-59
1SMB45AT3	1SMB45AT3		4-1-59
1SMB48AT3	1SMB48AT3		4-1-59
1SMB5.0AT3	1SMB5.0AT3		4-1-59
1SMB51AT3	1SMB51AT3		4-1-59
1SMB54AT3	1SMB54AT3		4-1-59

Industry Part Number	Motorola Direct Replacement	Motorola Similar Replacement	Page Number
1SMB58AT3	1SMB58AT3		4-1-59
1SMB5913BT3	1SMB5913BT3		4-2-78
1SMB5914BT3	1SMB5914BT3		4-2-78
1SMB5915BT3	1SMB5915BT3		4-2-78
1SMB5916BT3	1SMB5916BT3		4-2-78
1SMB5917BT3	1SMB5917BT3		4-2-78
1SMB5918BT3	1SMB5918BT3		4-2-78
1SMB5919BT3	1SMB5919BT3		4-2-78
1SMB5920BT3	1SMB5920BT3		4-2-78
1SMB5921BT3	1SMB5921BT3		4-2-78
1SMB5922BT3	1SMB5922BT3		4-2-78
1SMB5923BT3	1SMB5923BT3		4-2-78
1SMB5924BT3	1SMB5924BT3		4-2-78
1SMB5925BT3	1SMB5925BT3		4-2-78
1SMB5926BT3	1SMB5926BT3		4-2-78
1SMB5927BT3	1SMB5927BT3		4-2-78
1SMB5928BT3	1SMB5928BT3		4-2-78
1SMB5929BT3	1SMB5929BT3		4-2-79
1SMB5930BT3	1SMB5930BT3		4-2-79
1SMB5931BT3	1SMB5931BT3		4-2-79
1SMB5932BT3	1SMB5932BT3		4-2-79
1SMB5933BT3	1SMB5933BT3		4-2-79
1SMB5934BT3	1SMB5934BT3		4-2-79
1SMB5935BT3	1SMB5935BT3		4-2-79
1SMB5936BT3	1SMB5936BT3		4-2-79
1SMB5937BT3	1SMB5937BT3		4-2-79
1SMB5938BT3	1SMB5938BT3		4-2-79
1SMB5939BT3	1SMB5939BT3		4-2-79
1SMB5940BT3	1SMB5940BT3		4-2-79
1SMB5941BT3	1SMB5941BT3		4-2-79
1SMB5942BT3	1SMB5942BT3		4-2-79
1SMB5943BT3	1SMB5943BT3		4-2-79
1SMB5944BT3	1SMB5944BT3		4-2-79
1SMB5945BT3	1SMB5945BT3		4-2-79
1SMB5946BT3	1SMB5946BT3		4-2-79
1SMB5947BT3	1SMB5947BT3		4-2-79
1SMB5948BT3	1SMB5948BT3		4-2-79
1SMB5949BT3	1SMB5949BT3		4-2-79
1SMB5950BT3	1SMB5950BT3		4-2-79
1SMB5951BT3	1SMB5951BT3		4-2-79
1SMB5952BT3	1SMB5952BT3		4-2-79
1SMB5953BT3	1SMB5953BT3		4-2-79
1SMB5954BT3	1SMB5954BT3		4-2-79
1SMB5955BT3	1SMB5955BT3		4-2-79
1SMB5956BT3	1SMB5956BT3		4-2-79
1SMB6.0AT3	1SMB6.0AT3		4-1-59
1SMB6.5AT3	1SMB6.5AT3		4-1-59
1SMB60AT3	1SMB60AT3		4-1-59
1SMB64AT3	1SMB64AT3		4-1-59
1SMB7.0AT3	1SMB7.0AT3		4-1-59
1SMB7.5AT3	1SMB7.5AT3		4-1-59

CF = consult factory representative

2

CROSS-REFERENCE (continued)

Industry Part Number	Motorola Direct Replacement	Motorola Similar Replacement	Page Number
1SMB70AT3	1SMB70AT3		4-1-59
1SMB75AT3	1SMB75AT3		4-1-59
1SMB78AT3	1SMB78AT3		4-1-59
1SMB8.0AT3	1SMB8.0AT3		4-1-59
1SMB8.5AT3	1SMB8.5AT3		4-1-59
1SMB85AT3	1SMB85AT3		4-1-59
1SMB9.0AT3	1SMB9.0AT3		4-1-59
1SMB90AT3	1SMB90AT3		4-1-59
1SMC10AT3	1SMC10AT3		4-1-65
1SMC11AT3	1SMC11AT3		4-1-65
1SMC12AT3	1SMC12AT3		4-1-65
1SMC13AT3	1SMC13AT3		4-1-65
1SMC14AT3	1SMC14AT3		4-1-65
1SMC15AT3	1SMC15AT3		4-1-65
1SMC16AT3	1SMC16AT3		4-1-65
1SMC17AT3	1SMC17AT3		4-1-65
1SMC18AT3	1SMC18AT3		4-1-65
1SMC20AT3	1SMC20AT3		4-1-65
1SMC22AT3	1SMC22AT3		4-1-65
1SMC24AT3	1SMC24AT3		4-1-65
1SMC26AT3	1SMC26AT3		4-1-65
1SMC28AT3	1SMC28AT3		4-1-65
1SMC30AT3	1SMC30AT3		4-1-65
1SMC33AT3	1SMC33AT3		4-1-65
1SMC36AT3	1SMC36AT3		4-1-65
1SMC40AT3	1SMC40AT3		4-1-65
1SMC43AT3	1SMC43AT3		4-1-65
1SMC45AT3	1SMC45AT3		4-1-65
1SMC48AT3	1SMC48AT3		4-1-65
1SMC5.0AT3	1SMC5.0AT3		4-1-65
1SMC51AT3	1SMC51AT3		4-1-65
1SMC54AT3	1SMC54AT3		4-1-65
1SMC58AT3	1SMC58AT3		4-1-65
1SMC6.0AT3	1SMC6.0AT3		4-1-65
1SMC6.5AT3	1SMC6.5AT3		4-1-65
1SMC60AT3	1SMC60AT3		4-1-65
1SMC64AT3	1SMC64AT3		4-1-65
1SMC7.0AT3	1SMC7.0AT3		4-1-65
1SMC7.5AT3	1SMC7.5AT3		4-1-65
1SMC70AT3	1SMC70AT3		4-1-65
1SMC75AT3	1SMC75AT3		4-1-65
1SMC78AT3	1SMC78AT3		4-1-65
1SMC8.0AT3	1SMC8.0AT3		4-1-65
1SMC8.5AT3	1SMC8.5AT3		4-1-65
1SMC9.0AT3	1SMC9.0AT3		4-1-65
3EZ100D5	3EZ100D5		4-2-53
3EZ10D5	3EZ10D5		4-2-53
3EZ110D5	3EZ110D5		4-2-53
3EZ11D5	3EZ11D5		4-2-53
3EZ120D5	3EZ120D5		4-2-53
3EZ12D5	3EZ12D5		4-2-53

Industry Part Number	Motorola Direct Replacement	Motorola Similar Replacement	Page Number
3EZ130D5	3EZ130D5		4-2-53
3EZ13D5	3EZ13D5		4-2-53
3EZ140D5	3EZ140D5		4-2-53
3EZ14D5	3EZ14D5		4-2-53
3EZ150D5	3EZ150D5		4-2-53
3EZ15D5	3EZ15D5		4-2-53
3EZ160D5	3EZ160D5		4-2-53
3EZ16D5	3EZ16D5		4-2-53
3EZ170D5	3EZ170D5		4-2-53
3EZ17D5	3EZ17D5		4-2-53
3EZ180D5	3EZ180D5		4-2-53
3EZ18D5	3EZ18D5		4-2-53
3EZ190D5	3EZ190D5		4-2-53
3EZ19D5	3EZ19D5		4-2-53
3EZ200D5	3EZ200D5		4-2-54
3EZ20D5	3EZ20D5		4-2-53
3EZ220D5	3EZ220D5		4-2-54
3EZ22D5	3EZ22D5		4-2-53
3EZ240D5	3EZ240D5		4-2-54
3EZ24D5	3EZ24D5		4-2-53
3EZ270D5	3EZ270D5		4-2-54
3EZ27D5	3EZ27D5		4-2-53
3EZ28D5	3EZ28D5		4-2-53
3EZ3.9D5	3EZ3.9D5		4-2-53
3EZ300D5	3EZ300D5		4-2-54
3EZ30D5	3EZ30D5		4-2-53
3EZ330D5	3EZ330D5		4-2-54
3EZ33D5	3EZ33D5		4-2-53
3EZ360D5	3EZ360D5		4-2-54
3EZ36D5	3EZ36D5		4-2-53
3EZ39D5	3EZ39D5		4-2-53
3EZ4.3D5	3EZ4.3D5		4-2-53
3EZ4.7D5	3EZ4.7D5		4-2-53
3EZ400D5	3EZ400D5		4-2-54
3EZ43D5	3EZ43D5		4-2-53
3EZ47D5	3EZ47D5		4-2-53
3EZ5.1D5	3EZ5.1D5		4-2-53
3EZ5.6D5	3EZ5.6D5		4-2-53
3EZ51D5	3EZ51D5		4-2-53
3EZ56D5	3EZ56D5		4-2-53
3EZ6.2D5	3EZ6.2D5		4-2-53
3EZ6.8D5	3EZ6.8D5		4-2-53
3EZ62D5	3EZ62D5		4-2-53
3EZ68D5	3EZ68D5		4-2-53
3EZ7.5D5	3EZ7.5D5		4-2-53
3EZ75D5	3EZ75D5		4-2-53
3EZ8.2D5	3EZ8.2D5		4-2-53
3EZ82D5	3EZ82D5		4-2-53
3EZ9.1D5	3EZ9.1D5		4-2-53
3EZ91D5	3EZ91D5		4-2-53
BZV55C10	BZV55C10		4-2-73



CF = consult factory representative

CROSS-REFERENCE (continued)

2

Industry Part Number	Motorola Direct Replacement	Motorola Similar Replacement	Page Number
BZV55C11	BZV55C11		4-2-73
BZV55C12	BZV55C12		4-2-73
BZV55C13	BZV55C13		4-2-73
BZV55C15	BZV55C15		4-2-73
BZV55C16	BZV55C16		4-2-73
BZV55C18	BZV55C18		4-2-73
BZV55C20	BZV55C20		4-2-73
BZV55C22	BZV55C22		4-2-73
BZV55C24	BZV55C24		4-2-73
BZV55C27	BZV55C27		4-2-73
BZV55C2V4	BZV55C2V4		4-2-73
BZV55C2V7	BZV55C2V7		4-2-73
BZV55C30	BZV55C30		4-2-73
BZV55C33	BZV55C33		4-2-73
BZV55C36	BZV55C36		4-2-73
BZV55C39	BZV55C39		4-2-73
BZV55C3V0	BZV55C3V0		4-2-73
BZV55C3V3	BZV55C3V3		4-2-73
BZV55C3V6	BZV55C3V6		4-2-73
BZV55C3V9	BZV55C3V9		4-2-73
BZV55C43	BZV55C43		4-2-73
BZV55C47	BZV55C47		4-2-73
BZV55C4V3	BZV55C4V3		4-2-73
BZV55C4V7	BZV55C4V7		4-2-73
BZV55C51	BZV55C51		4-2-73
BZV55C56	BZV55C56		4-2-73
BZV55C5V1	BZV55C5V1		4-2-73
BZV55C5V6	BZV55C5V6		4-2-73
BZV55C6V2	BZV55C6V2		4-2-73
BZV55C6V8	BZV55C6V8		4-2-73
BZV55C7V5	BZV55C7V5		4-2-73
BZV55C8V2	BZV55C8V2		4-2-73
BZV55C9V1	BZV55C9V1		4-2-73
BZW04-10		SA10A	4-1-26
BZW04-102		SA100A	4-1-27
BZW04-102B		SA100CA	4-1-27
BZW04-10B		SA10CA	4-1-26
BZW04-11		SA11A	4-1-26
BZW04-111		SA110A	4-1-27
BZW04-111B		SA110CA	4-1-27
BZW04-11B		SA11CA	4-1-26
BZW04-128		SA130A	4-1-27
BZW04-128B		SA130CA	4-1-27
BZW04-13		SA13A	4-1-26
BZW04-136		SA150A	4-1-27
BZW04-136B		SA150CA	4-1-27
BZW04-13B		SA13CA	4-1-26
BZW04-14		SA14A	4-1-26
BZW04-145		SA150A	4-1-27
BZW04-145B		SA150CA	4-1-27
BZW04-14B		SA14CA	4-1-26

Industry Part Number	Motorola Direct Replacement	Motorola Similar Replacement	Page Number
BZW04-15		SA16A	4-1-26
BZW04-154		SA160A	4-1-27
BZW04-154B		SA160CA	4-1-27
BZW04-15B		SA16CA	4-1-26
BZW04-17		SA17A	4-1-26
BZW04-171		SA170A	4-1-27
BZW04-171B		SA170CA	4-1-27
BZW04-17B		SA17CA	4-1-26
BZW04-19		SA20	4-1-26
BZW04-19B		SA20	4-1-26
BZW04-20		SA22A	4-1-26
BZW04-20B		SA22CA	4-1-26
BZW04-23		SA24A	4-1-26
BZW04-23B		SA24CA	4-1-26
BZW04-26		SA26A	4-1-26
BZW04-26B		SA26CA	4-1-26
BZW04-28		SA28A	4-1-26
BZW04-28B		SA28CA	4-1-26
BZW04-31		SA33A	4-1-26
BZW04-31B		SA33CA	4-1-26
BZW04-33		SA33A	4-1-26
BZW04-33B		SA33CA	4-1-26
BZW04-37		SA40A	4-1-27
BZW04-37B		SA40CA	4-1-27
BZW04-40		SA40A	4-1-27
BZW04-40B		SA40CA	4-1-27
BZW04-44		SA45A	4-1-27
BZW04-44B		SA45CA	4-1-27
BZW04-48		SA48A	4-1-27
BZW04-48B		SA48CA	4-1-27
BZW04-53		SA54A	4-1-27
BZW04-53B		SA54CA	4-1-27
BZW04-58		SA58A	4-1-27
BZW04-58B		SA58CA	4-1-27
BZW04-5V8		SA6.0A	4-1-26
BZW04-5V8B		SA6.0CA	4-1-26
BZW04-64		SA64A	4-1-27
BZW04-64B		SA64CA	4-1-27
BZW04-6V4		SA6.5A	4-1-26
BZW04-6V4B		SA6.5CA	4-1-26
BZW04-70		SA70A	4-1-27
BZW04-70B		SA70CA	4-1-27
BZW04-78		SA78A	4-1-27
BZW04-78B		SA78CA	4-1-27
BZW04-7V0		SA7.0A	4-1-26
BZW04-7V0B		SA7.0CA	4-1-26
BZW04-7V8		SA8.0A	4-1-26
BZW04-7V8B		SA8.0CA	4-1-26
BZW04-85		SA85A	4-1-27
BZW04-85B		SA85CA	4-1-27
BZW04-8V5		SA8.5A	4-1-26

CF = consult factory representative

CROSS-REFERENCE (continued)

Industry Part Number	Motorola Direct Replacement	Motorola Similar Replacement	Page Number
BZW04-8V5B		SA8.5CA	4-1-26
BZW04-94		SA100A	4-1-27
BZW04-94B		SA100CA	4-1-27
BZW04-9V4		SA10A	4-1-26
BZW04-9V4B		SA10CA	4-1-26
BZW04P10		SA10A	4-1-26
BZW04P102		SA100A	4-1-27
BZW04P102B		SA100CA	4-1-27
BZW04P10B		SA10CA	4-1-26
BZW04P11		SA11A	4-1-26
BZW04P111		SA110A	4-1-27
BZW04P111B		SA110CA	4-1-27
BZW04P11B		SA11CA	4-1-26
BZW04P128		SA130A	4-1-27
BZW04P128B		SA130CA	4-1-27
BZW04P13		SA13A	4-1-26
BZW04P136		SA150A	4-1-27
BZW04P136B		SA150CA	4-1-27
BZW04P13B		SA13CA	4-1-26
BZW04P14		SA14A	4-1-26
BZW04P145		SA150A	4-1-27
BZW04P145B		SA150CA	4-1-27
BZW04P14B		SA14CA	4-1-26
BZW04P15		SA16A	4-1-26
BZW04P154		SA160A	4-1-27
BZW04P154B		SA160CA	4-1-27
BZW04P15B		SA16CA	4-1-26
BZW04P17		SA17A	4-1-26
BZW04P171		SA170A	4-1-27
BZW04P171B		SA170CA	4-1-27
BZW04P17B		SA17CA	4-1-26
BZW04P19		SA20A	4-1-26
BZW04P19B		SA20CA	4-1-26
BZW04P20		SA22A	4-1-26
BZW04P20B		SA22CA	4-1-26
BZW04P23		SA24A	4-1-26
BZW04P23B		SA24CA	4-1-26
BZW04P26		SA26A	4-1-26
BZW04P26B		SA26CA	4-1-26
BZW04P28		SA28A	4-1-26
BZW04P28B		SA28CA	4-1-26
BZW04P31		SA33A	4-1-26
BZW04P31B		SA33CA	4-1-26
BZW04P33		SA33A	4-1-26
BZW04P33B		SA33CA	4-1-26
BZW04P37		SA40A	4-1-27
BZW04P37B		SA40CA	4-1-27
BZW04P40		SA40A	4-1-27
BZW04P40B		SA40CA	4-1-27
BZW04P44		SA45A	4-1-27
BZW04P44B		SA45CA	4-1-27

Industry Part Number	Motorola Direct Replacement	Motorola Similar Replacement	Page Number
BZW04P48		SA48A	4-1-27
BZW04P48B		SA48CA	4-1-27
BZW04P53		SA54A	4-1-27
BZW04P53B		SA54CA	4-1-27
BZW04P58		SA58A	4-1-27
BZW04P58B		SA58CA	4-1-27
BZW04P5V8		SA6.0A	4-1-26
BZW04P5V8B		SA6.0CA	4-1-26
BZW04P64		SA64A	4-1-27
BZW04P64B		SA64CA	4-1-27
BZW04P6V4		SA6.5A	4-1-26
BZW04P6V4B		SA6.5CA	4-1-26
BZW04P70		SA70A	4-1-27
BZW04P70B		SA70CA	4-1-27
BZW04P78		SA78A	4-1-27
BZW04P78B		SA78CA	4-1-27
BZW04P7V0		SA7.0A	4-1-26
BZW04P7V0B		SA7.0CA	4-1-26
BZW04P7V8		SA8.0A	4-1-26
BZW04P7V8B		SA8.0CA	4-1-26
BZW04P85		SA85A	4-1-27
BZW04P85B		SA85CA	4-1-27
BZW04P8V5		SA8.5A	4-1-26
BZW04P8V5B		SA8.5CA	4-1-26
BZW04P94		SA100A	4-1-27
BZW04P94B		SA100CA	4-1-27
BZW04P9V4		SA10A	4-1-26
BZW04P9V4B		SA10CA	4-1-26
BZW06-10		P6KE12A	4-1-33
BZW06-102		P6KE120A	4-1-34
BZW06-102B		P6KE120CA	4-1-34
BZW06-10B		P6KE12CA	4-1-33
BZW06-11		P6KE13A	4-1-33
BZW06-111		P6KE130A	4-1-34
BZW06-111B		P6KE130CA	4-1-34
BZW06-11B		P6KE13CA	4-1-33
BZW06-128		P6KE150A	4-1-34
BZW06-128B		P6KE150CA	4-1-34
BZW06-13		P6KE15A	4-1-33
BZW06-136		P6KE160A	4-1-34
BZW06-136B		P6KE160CA	4-1-34
BZW06-13B		P6KE15CA	4-1-33
BZW06-14		P6KE16A	4-1-33
BZW06-145		P6KE170A	4-1-34
BZW06-145B		P6KE170CA	4-1-34
BZW06-14B		P6KE16CA	4-1-33
BZW06-15		P6KE18A	4-1-33
BZW06-154		P6KE180A	4-1-34
BZW06-154B		P6KE180CA	4-1-34
BZW06-15B		P6KE18CA	4-1-33
BZW06-17		P6KE20A	4-1-33

CF = consult factory representative



CROSS-REFERENCE (continued)

Industry Part Number	Motorola Direct Replacement	Motorola Similar Replacement	Page Number
BZW06-171		P6KE200A	4-1-34
BZW06-171B		P6KE200CA	4-1-34
BZW06-17B		P6KE200CA	4-1-33
BZW06-188		1.5KE220A	4-1-44
BZW06-188B		1.5KE220CA	4-1-44
BZW06-19		P6KE22A	4-1-33
BZW06-19B		P6KE22CA	4-1-33
BZW06-20		P6KE24A	4-1-33
BZW06-20B		P6KE24CA	4-1-33
BZW06-213		1.5KE250A	4-1-44
BZW06-213B		1.5KE250CA	4-1-44
BZW06-23		P6KE27A	4-1-33
BZW06-23B		P6KE27CA	4-1-33
BZW06-26		P6KE30A	4-1-33
BZW06-26B		P6KE30CA	4-1-33
BZW06-28		P6KE33A	4-1-33
BZW06-28B		P6KE33CA	4-1-33
BZW06-31		P6KE36A	4-1-33
BZW06-31B		P6KE36CA	4-1-33
BZW06-33		P6KE39A	4-1-33
BZW06-33B		P6KE39CA	4-1-33
BZW06-37		P6KE43A	4-1-33
BZW06-37B		P6KE43CA	4-1-33
BZW06-40		P6KE47A	4-1-33
BZW06-40B		P6KE47CA	4-1-33
BZW06-44		P6KE51A	4-1-33
BZW06-44B		P6KE51CA	4-1-33
BZW06-48		P6KE56A	4-1-33
BZW06-48B		P6KE56CA	4-1-33
BZW06-53		P6KE62A	4-1-33
BZW06-53B		P6KE62CA	4-1-33
BZW06-58		P6KE68A	4-1-34
BZW06-58B		P6KE68CA	4-1-34
BZW06-5V8		P6KE6.8A	4-1-33
BZW06-5V8B		P6KE6.8CA	4-1-33
BZW06-64		P6KE75A	4-1-34
BZW06-64B		P6KE75CA	4-1-34
BZW06-6V4		P6KE7.5A	4-1-33
BZW06-6V4B		P6KE7.5CA	4-1-33
BZW06-70		P6KE82A	4-1-34
BZW06-70B		P6KE82CA	4-1-34
BZW06-78		P6KE91A	4-1-34
BZW06-78B		P6KE91CA	4-1-34
BZW06-7V0		P6KE8.2A	4-1-33
BZW06-7V0B		P6KE8.2CA	4-1-33
BZW06-7V8		P6KE9.1A	4-1-33
BZW06-7V8B		P6KE9.1CA	4-1-33
BZW06-85		P6KE100A	4-1-34
BZW06-85B		P6KE100CA	4-1-34
BZW06-8V5		P6KE10A	4-1-33
BZW06-8V5B		P6KE10CA	4-1-33

Industry Part Number	Motorola Direct Replacement	Motorola Similar Replacement	Page Number
BZW06-94		P6KE110A	4-1-34
BZW06-94B		P6KE110CA	4-1-34
BZW06-9V4		P6KE11A	4-1-33
BZW06-9V4B		P6KE11CA	4-1-33
BZW06P10		P6KE12A	4-1-33
BZW06P102		P6KE120A	4-1-34
BZW06P102B		P6KE120CA	4-1-34
BZW06P10B		P6KE12CA	4-1-33
BZW06P11		P6KE13A	4-1-33
BZW06P111		P6KE130A	4-1-34
BZW06P111B		P6KE130CA	4-1-34
BZW06P11B		P6KE13CA	4-1-33
BZW06P128		P6KE150A	4-1-34
BZW06P128B		P6KE150CA	4-1-34
BZW06P13		P6KE15A	4-1-33
BZW06P136		P6KE160A	4-1-34
BZW06P136B		P6KE160CA	4-1-34
BZW06P13B		P6KE15CA	4-1-33
BZW06P14		P6KE16A	4-1-33
BZW06P145		P6KE170A	4-1-34
BZW06P145B		P6KE170CA	4-1-34
BZW06P14B		P6KE16CA	4-1-33
BZW06P15		P6KE18A	4-1-33
BZW06P154		P6KE180A	4-1-34
BZW06P154B		P6KE180CA	4-1-34
BZW06P15B		P6KE18CA	4-1-33
BZW06P17		P6KE20A	4-1-33
BZW06P171		P6KE200A	4-1-34
BZW06P171B		P6KE200CA	4-1-34
BZW06P17B		P6KE20CA	4-1-33
BZW06P188		1.5KE220A	4-1-44
BZW06P188B		1.5KE220CA	4-1-44
BZW06P19		P6KE22A	4-1-33
BZW06P19B		P6KE22CA	4-1-33
BZW06P20		P6KE24A	4-1-33
BZW06P20B		P6KE24CA	4-1-33
BZW06P213		1.5KE250A	4-1-44
BZW06P213B		1.5KE250CA	4-1-44
BZW06P23		P6KE27A	4-1-33
BZW06P23B		P6KE27CA	4-1-33
BZW06P26		P6KE30A	4-1-33
BZW06P26B		P6KE30CA	4-1-33
BZW06P28		P6KE33A	4-1-33
BZW06P28B		P6KE33CA	4-1-33
BZW06P31		P6KE36A	4-1-33
BZW06P31B		P6KE36CA	4-1-33
BZW06P33		P6KE39A	4-1-33
BZW06P33B		P6KE39CA	4-1-33
BZW06P37		P6KE43A	4-1-33
BZW06P37B		P6KE43CA	4-1-33
BZW06P40		P6KE47A	4-1-33

CF = consult factory representative



CROSS-REFERENCE (continued)

Industry Part Number	Motorola Direct Replacement	Motorola Similar Replacement	Page Number
BZW06P40B		P6KE47CA	4-1-33
BZW06P44		P6KE51A	4-1-33
BZW06P44B		P6KE51CA	4-1-33
BZW06P48		P6KE56A	4-1-33
BZW06P48B		P6KE56CA	4-1-33
BZW06P53		P6KE62A	4-1-33
BZW06P53B		P6KE62CA	4-1-33
BZW06P58		P6KE68A	4-1-34
BZW06P58B		P6KE68CA	4-1-34
BZW06P5V8		P6KE6.8A	4-1-33
BZW06P5V8B		P6KE6.8CA	4-1-33
BZW06P64		P6KE75A	4-1-34
BZW06P64B		P6KE75CA	4-1-34
BZW06P6V4		P6KE7.5A	4-1-33
BZW06P6V4B		P6KE7.5CA	4-1-33
BZW06P70		P6KE82A	4-1-34
BZW06P70B		P6KE82CA	4-1-34
BZW06P78		P6KE91A	4-1-34
BZW06P78B		P6KE91CA	4-1-34
BZW06P7V0		P6KE8.2A	4-1-33
BZW06P7V0B		P6KE8.2CA	4-1-33
BZW06P7V8		P6KE9.1A	4-1-33
BZW06P7V8B		P6KE9.1CA	4-1-33
BZW06P85		P6KE100A	4-1-34
BZW06P85B		P6KE100CA	4-1-34
BZW06P8V5		P6KE10A	4-1-33
BZW06P8V5B		P6KE10CA	4-1-33
BZW06P94		P6KE110A	4-1-34
BZW06P94B		P6KE110CA	4-1-34
BZW06P9V4		P6KE11A	4-1-33
BZW06P9V4B		P6KE11CA	4-1-33
BZW07-10		1N6276	4-1-43
BZW07-10B		1.5KE16C	4-1-43
BZW07-110		1N6300	4-1-44
BZW07-110B		1.5KE160C	4-1-44
BZW07-27		1N6284	4-1-43
BZW07-27B		1.5KE36C	4-1-43
BZW07-43		1N6290	4-1-44
BZW07-43B		1.5KE62C	4-1-44
BZW11-10		1N6276	4-1-43
BZW11-10B		1.5KE16C	4-1-43
BZW11-110		1N6300	4-1-44
BZW11-110B		1.5KE160C	4-1-44
BZW11-27		1N6284	4-1-43
BZW11-27B		1.5KE36C	4-1-43
BZW11-43		1N6290	4-1-44
BZW11-43B		1.5KE62C	4-1-44
BZX55C10	BZX55C10		4-2-34
BZX55C11	BZX55C11		4-2-34
BZX55C12	BZX55C12		4-2-34
BZX55C13	BZX55C13		4-2-34

Industry Part Number	Motorola Direct Replacement	Motorola Similar Replacement	Page Number
BZX55C15	BZX55C15		4-2-34
BZX55C16	BZX55C16		4-2-34
BZX55C18	BZX55C18		4-2-34
BZX55C20	BZX55C20		4-2-34
BZX55C22	BZX55C22		4-2-34
BZX55C24	BZX55C24		4-2-34
BZX55C27	BZX55C27		4-2-34
BZX55C2V4	BZX55C2V4		4-2-34
BZX55C2V7	BZX55C2V7		4-2-34
BZX55C30	BZX55C30		4-2-34
BZX55C33	BZX55C33		4-2-34
BZX55C36	BZX55C36		4-2-34
BZX55C39	BZX55C39		4-2-34
BZX55C3V0	BZX55C3V0		4-2-34
BZX55C3V3	BZX55C3V3		4-2-34
BZX55C3V6	BZX55C3V6		4-2-34
BZX55C3V9	BZX55C3V9		4-2-34
BZX55C43	BZX55C43		4-2-34
BZX55C47	BZX55C47		4-2-34
BZX55C4V3	BZX55C4V3		4-2-34
BZX55C4V7	BZX55C4V7		4-2-34
BZX55C51	BZX55C51		4-2-34
BZX55C56	BZX55C56		4-2-34
BZX55C5V1	BZX55C5V1		4-2-34
BZX55C5V6	BZX55C5V6		4-2-34
BZX55C62	BZX55C62		4-2-34
BZX55C68	BZX55C68		4-2-34
BZX55C6V2	BZX55C6V2		4-2-34
BZX55C6V8	BZX55C6V8		4-2-34
BZX55C75	BZX55C75		4-2-34
BZX55C7V5	BZX55C7V5		4-2-34
BZX55C82	BZX55C82		4-2-34
BZX55C8V2	BZX55C8V2		4-2-34
BZX55C91	BZX55C91		4-2-34
BZX55C9V1	BZX55C9V1		4-2-34
BZX79C10	BZX79C10		4-2-35
BZX79C100	BZX79C100		4-2-35
BZX79C11	BZX79C11		4-2-35
BZX79C110	BZX79C110		4-2-35
BZX79C12	BZX79C12		4-2-35
BZX79C120	BZX79C120		4-2-35
BZX79C13	BZX79C13		4-2-35
BZX79C130	BZX79C130		4-2-35
BZX79C15	BZX79C15		4-2-35
BZX79C150	BZX79C150		4-2-35
BZX79C16	BZX79C16		4-2-35
BZX79C160	BZX79C160		4-2-35
BZX79C18	BZX79C18		4-2-35
BZX79C180	BZX79C180		4-2-35
BZX79C20	BZX79C20		4-2-35
BZX79C200	BZX79C200		4-2-35



CF = consult factory representative

CROSS-REFERENCE (continued)

2

Industry Part Number	Motorola Direct Replacement	Motorola Similar Replacement	Page Number
BZX79C22	BZX79C22		4-2-35
BZX79C24	BZX79C24		4-2-35
BZX79C27	BZX79C27		4-2-35
BZX79C2V4	BZX79C2V4		4-2-35
BZX79C2V7	BZX79C2V7		4-2-35
BZX79C30	BZX79C30		4-2-35
BZX79C33	BZX79C33		4-2-35
BZX79C36	BZX79C36		4-2-35
BZX79C39	BZX79C39		4-2-35
BZX79C3V0	BZX79C3V0		4-2-35
BZX79C3V3	BZX79C3V3		4-2-35
BZX79C3V6	BZX79C3V6		4-2-35
BZX79C3V9	BZX79C3V9		4-2-35
BZX79C43	BZX79C43		4-2-35
BZX79C47	BZX79C47		4-2-35
BZX79C4V3	BZX79C4V3		4-2-35
BZX79C4V7	BZX79C4V7		4-2-35
BZX79C51	BZX79C51		4-2-35
BZX79C56	BZX79C56		4-2-35
BZX79C5V1	BZX79C5V1		4-2-35
BZX79C5V6	BZX79C5V6		4-2-35
BZX79C62	BZX79C62		4-2-35
BZX79C68	BZX79C68		4-2-35
BZX79C6V2	BZX79C6V2		4-2-35
BZX79C6V8	BZX79C6V8		4-2-35
BZX79C75	BZX79C75		4-2-35
BZX79C7V5	BZX79C7V5		4-2-35
BZX79C82	BZX79C82		4-2-35
BZX79C8V2	BZX79C8V2		4-2-35
BZX79C91	BZX79C91		4-2-35
BZX79C9V1	BZX79C9V1		4-2-35
BZX83C10	BZX83C10		4-2-36
BZX83C11	BZX83C11		4-2-36
BZX83C12	BZX83C12		4-2-36
BZX83C13	BZX83C13		4-2-36
BZX83C15	BZX83C15		4-2-36
BZX83C16	BZX83C16		4-2-36
BZX83C18	BZX83C18		4-2-36
BZX83C20	BZX83C20		4-2-36
BZX83C22	BZX83C22		4-2-36
BZX83C24	BZX83C24		4-2-36
BZX83C27	BZX83C27		4-2-36
BZX83C2V7	BZX83C2V7		4-2-36
BZX83C30	BZX83C30		4-2-36
BZX83C33	BZX83C33		4-2-36
BZX83C3V0	BZX83C3V0		4-2-36
BZX83C3V3	BZX83C3V3		4-2-36
BZX83C3V6	BZX83C3V6		4-2-36
BZX83C3V9	BZX83C3V9		4-2-36
BZX83C4V3	BZX83C4V3		4-2-36
BZX83C4V7	BZX83C4V7		4-2-36

Industry Part Number	Motorola Direct Replacement	Motorola Similar Replacement	Page Number
BZX83C5V1	BZX83C5V1		4-2-36
BZX83C5V6	BZX83C5V6		4-2-36
BZX83C6V2	BZX83C6V2		4-2-36
BZX83C6V8	BZX83C6V8		4-2-36
BZX83C7V5	BZX83C7V5		4-2-36
BZX83C8V2	BZX83C8V2		4-2-36
BZX83C9V1	BZX83C9V1		4-2-36
BZX84C10L	BZX84C10L		4-2-65
BZX84C11L	BZX84C11L		4-2-65
BZX84C12L	BZX84C12L		4-2-65
BZX84C13L	BZX84C13L		4-2-65
BZX84C15L	BZX84C15L		4-2-65
BZX84C16L	BZX84C16L		4-2-65
BZX84C18L	BZX84C18L		4-2-65
BZX84C20L	BZX84C20L		4-2-65
BZX84C22L	BZX84C22L		4-2-65
BZX84C24L	BZX84C24L		4-2-65
BZX84C27L	BZX84C27L		4-2-65
BZX84C2V4L	BZX84C2V4L		4-2-65
BZX84C2V7L	BZX84C2V7L		4-2-65
BZX84C30L	BZX84C30L		4-2-65
BZX84C33L	BZX84C33L		4-2-65
BZX84C36L	BZX84C36L		4-2-65
BZX84C39L	BZX84C39L		4-2-65
BZX84C3V0L	BZX84C3V0L		4-2-65
BZX84C3V3L	BZX84C3V3L		4-2-65
BZX84C3V6L	BZX84C3V6L		4-2-65
BZX84C3V9L	BZX84C3V9L		4-2-65
BZX84C43L	BZX84C43L		4-2-65
BZX84C47L	BZX84C47L		4-2-65
BZX84C4V3L	BZX84C4V3L		4-2-65
BZX84C4V7L	BZX84C4V7L		4-2-65
BZX84C51L	BZX84C51L		4-2-65
BZX84C56L	BZX84C56L		4-2-65
BZX84C5V1L	BZX84C5V1L		4-2-65
BZX84C5V6L	BZX84C5V6L		4-2-65
BZX84C62L	BZX84C62L		4-2-65
BZX84C68L	BZX84C68L		4-2-65
BZX84C6V2L	BZX84C6V2L		4-2-65
BZX84C6V8L	BZX84C6V8L		4-2-65
BZX84C75L	BZX84C75L		4-2-65
BZX84C7V5L	BZX84C7V5L		4-2-65
BZX84C8V2L	BZX84C8V2L		4-2-65
BZX84C9V1L	BZX84C9V1L		4-2-65
BZX85C10	BZX85C10		4-2-45
BZX85C100	BZX85C100		4-2-45
BZX85C11	BZX85C11		4-2-45
BZX85C12	BZX85C12		4-2-45
BZX85C13	BZX85C13		4-2-45
BZX85C15	BZX85C15		4-2-45
BZX85C16	BZX85C16		4-2-45

CF = consult factory representative

CROSS-REFERENCE (continued)

Industry Part Number	Motorola Direct Replacement	Motorola Similar Replacement	Page Number	Industry Part Number	Motorola Direct Replacement	Motorola Similar Replacement	Page Number
BZX85C18	BZX85C18		4-2-45	BZY88C5V6		BZY88C5V6	CF
BZX85C20	BZX85C20		4-2-45	BZY88C6V2		BZY88C6V2	CF
BZX85C22	BZX85C22		4-2-45	BZY88C6V8		BZY88C6V8	CF
BZX85C24	BZX85C24		4-2-45	BZY88C7V5		BZY88C7V5	CF
BZX85C27	BZX85C27		4-2-45	BZY88C8V2		BZY88C8V2	CF
BZX85C30	BZX85C30		4-2-45	BZY88C9V1		BZY88C9V1	CF
BZX85C33	BZX85C33		4-2-45	DTZ10		1.5KE10C	4-1-43
BZX85C36	BZX85C36		4-2-45	DTZ100		1.5KE100C	4-1-44
BZX85C39	BZX85C39		4-2-45	DTZ100A		1.5KE100CA	4-1-44
BZX85C3V3	BZX85C3V3		4-2-45	DTZ10A		1.5KE10CA	4-1-43
BZX85C3V6	BZX85C3V6		4-2-45	DTZ11		1.5KE11C	4-1-43
BZX85C3V9	BZX85C3V9		4-2-45	DTZ110		1.5KE110C	4-1-44
BZX85C43	BZX85C43		4-2-45	DTZ110A		1.5KE110CA	4-1-44
BZX85C47	BZX85C47		4-2-45	DTZ11A		1.5KE11CA	4-1-43
BZX85C4V3	BZX85C4V3		4-2-45	DTZ12		1.5KE12C	4-1-43
BZX85C4V7	BZX85C4V7		4-2-45	DTZ120		1.5KE120C	4-1-44
BZX85C51	BZX85C51		4-2-45	DTZ120A		1.5KE120CA	4-1-44
BZX85C56	BZX85C56		4-2-45	DTZ12A		1.5KE12CA	4-1-43
BZX85C5V1	BZX85C5V1		4-2-45	DTZ13		1.5KE13C	4-1-43
BZX85C5V6	BZX85C5V6		4-2-45	DTZ130		1.5KE130C	4-1-44
BZX85C62	BZX85C62		4-2-45	DTZ130A		1.5KE130CA	4-1-44
BZX85C68	BZX85C68		4-2-45	DTZ13A		1.5KE13CA	4-1-43
BZX85C6V2	BZX85C6V2		4-2-45	DTZ15		1.5KE15C	4-1-43
BZX85C6V8	BZX85C6V8		4-2-45	DTZ150		1.5KE150C	4-1-44
BZX85C75	BZX85C75		4-2-45	DTZ150A		1.5KE150CA	4-1-44
BZX85C7V5	BZX85C7V5		4-2-45	DTZ15A		1.5KE15CA	4-1-43
BZX85C82	BZX85C82		4-2-45	DTZ16		1.5KE16C	4-1-43
BZX85C8V2	BZX85C8V2		4-2-45	DTZ160		1.5KE160C	4-1-44
BZX85C91	BZX85C91		4-2-45	DTZ160A		1.5KE160CA	4-1-44
BZX85C9V1	BZX85C9V1		4-2-45	DTZ16A		1.5KE16CA	4-1-43
BZY88C10		BZY88C10	CF	DTZ170		1.5KE170C	4-1-44
BZY88C11		BZY88C11	CF	DTZ170A		1.5KE170CA	4-1-44
BZY88C12		BZY88C12	CF	DTZ18		1.5KE18C	4-1-43
BZY88C13		BZY88C13	CF	DTZ180		1.5KE180C	4-1-44
BZY88C15		BZY88C15	CF	DTZ180A		1.5KE180CA	4-1-44
BZY88C16		BZY88C16	CF	DTZ18A		1.5KE18CA	4-1-43
BZY88C18		BZY88C18	CF	DTZ20		1.5KE20C	4-1-43
BZY88C20		BZY88C20	CF	DTZ200		1.5KE200C	4-1-44
BZY88C22		BZY88C22	CF	DTZ200A		1.5KE200CA	4-1-44
BZY88C24		BZY88C24	CF	DTZ20A		1.5KE20CA	4-1-43
BZY88C27		BZY88C27	CF	DTZ22		1.5KE22C	4-1-43
BZY88C2V7		BZY88C2V7	CF	DTZ220		1.5KE220C	4-1-44
BZY88C30		BZY88C30	CF	DTZ220A		1.5KE220CA	4-1-44
BZY88C33		BZY88C33	CF	DTZ22A		1.5KE22CA	4-1-43
BZY88C3V0		BZY88C3V0	CF	DTZ24		1.5KE24C	4-1-43
BZY88C3V3		BZY88C3V3	CF	DTZ24A		1.5KE24CA	4-1-43
BZY88C3V6		BZY88C3V6	CF	DTZ250		1.5KE250C	4-1-44
BZY88C3V9		BZY88C3V9	CF	DTZ250A		1.5KE250CA	4-1-44
BZY88C4V3		BZY88C4V3	CF	DTZ27		1.5KE27C	4-1-43
BZY88C4V7		BZY88C4V7	CF	DTZ27A		1.5KE27CA	4-1-43
BZY88C5V1		BZY88C5V1	CF	DTZ30		1.5KE30C	4-1-43

CF = consult factory representative



CROSS-REFERENCE (continued)

Industry Part Number	Motorola Direct Replacement	Motorola Similar Replacement	Page Number
DTZ30A		1.5KE30CA	4-1-43
DTZ33		1.5KE33C	4-1-43
DTZ33A		1.5KE33CA	4-1-43
DTZ36		1.5KE36C	4-1-43
DTZ36A		1.5KE36CA	4-1-43
DTZ39		1.5KE39C	4-1-43
DTZ39A		1.5KE39CA	4-1-43
DTZ43		1.5KE43C	4-1-43
DTZ43A		1.5KE43CA	4-1-43
DTZ47		1.5KE47C	4-1-43
DTZ47A		1.5KE47CA	4-1-43
DTZ51		1.5KE51C	4-1-43
DTZ51A		1.5KE51CA	4-1-43
DTZ56		1.5KE56C	4-1-44
DTZ56A		1.5KE56CA	4-1-44
DTZ62		1.5KE62C	4-1-44
DTZ62A		1.5KE62CA	4-1-44
DTZ68		1.5KE68C	4-1-44
DTZ68A		1.5KE68CA	4-1-44
DTZ6V8		1.5KE6.8C	4-1-43
DTZ6V8A		1.5KE6.8CA	4-1-43
DTZ75		1.5KE75C	4-1-44
DTZ75A		1.5KE75CA	4-1-44
DTZ7V5		1.5KE7.5C	4-1-43
DTZ7V5A		1.5KE7.5CA	4-1-43
DTZ82		1.5KE82C	4-1-44
DTZ82A		1.5KE82CA	4-1-44
DTZ8V2		1.5KE8.2C	4-1-43
DTZ8V2A		1.5KE8.2CA	4-1-43
DTZ91		1.5KE91C	4-1-44
DTZ91A		1.5KE91CA	4-1-44
DTZ9V1		1.5KE9.1C	4-1-43
DTZ9V1A		1.5KE9.1CA	4-1-43
GMP-5		1N6373	4-1-46
GMP-5A		1N6373	4-1-46
GMP-5B		1N6373	4-1-46
ICT-10		ICTE-10	4-1-46
ICT-10C		ICTE-10C	4-1-46
ICT-12		ICTE-12	4-1-46
ICT-12C		ICTE-12C	4-1-46
ICT-15		ICTE-15	4-1-46
ICT-15C		ICTE-15C	4-1-46
ICT-18		ICTE-18	4-1-46
ICT-18C		ICTE-18C	4-1-46
ICT-22		ICTE-22	4-1-46
ICT-22C		ICTE-22C	4-1-46
ICT-36		ICTE-36	4-1-46
ICT-36C		ICTE-36C	4-1-46
ICT-45		ICTE-45	4-1-46
ICT-45C		ICTE-45C	4-1-46
ICT-5		ICTE-5	4-1-46

Industry Part Number	Motorola Direct Replacement	Motorola Similar Replacement	Page Number
ICT-8		ICTE-8	4-1-46
ICT-8C		ICTE-8C	4-1-46
ICTE-10	ICTE-10		4-1-46
ICTE-10C	ICTE-10C		4-1-46
ICTE-12	ICTE-12		4-1-46
ICTE-12C	ICTE-12C		4-1-46
ICTE-15	ICTE-15		4-1-46
ICTE-15C	ICTE-15C		4-1-46
ICTE-18	ICTE-18		4-1-46
ICTE-18C	ICTE-18C		4-1-46
ICTE-22	ICTE-22		4-1-46
ICTE-22C	ICTE-22C		4-1-46
ICTE-36	ICTE-36		4-1-46
ICTE-36C	ICTE-36C		4-1-46
ICTE-45	ICTE-45		4-1-46
ICTE-45C	ICTE-45C		4-1-46
ICTE-5	ICTE-5		4-1-46
ICTE-8	ICTE-8		4-1-46
ICTE-8C	ICTE-8C		4-1-46
LVA100A		MZ5530B	4-2-38
LVA3100A		MZ5530B	4-2-38
LVA343A		MZ5521B	4-2-38
LVA347A		MZ5522B	4-2-38
LVA351A		MZ5523B	4-2-38
LVA356A		MZ5524B	4-2-38
LVA362A		MZ5525B	4-2-38
LVA368A		MZ5526B	4-2-38
LVA375A		MZ5527B	4-2-38
LVA382A		MZ5528B	4-2-38
LVA391A		MZ5529B	4-2-38
LVA43A		MZ5521B	4-2-38
LVA47A		MZ5522B	4-2-38
LVA51A		MZ5523B	4-2-38
LVA56A		MZ5524B	4-2-38
LVA62A		MZ5525B	4-2-38
LVA68A		MZ5526B	4-2-38
LVA75A		MZ5527B	4-2-38
LVA82A		MZ5528B	4-2-38
LVA91A		MZ5529B	4-2-38
MCL1300	MCL1300		CF
MCL1301	MCL1301		CF
MCL1302	MCL1302		CF
MCL1303	MCL1303		CF
MCL1304	MCL1304		CF
MLL4099		MLL4692	4-2-74
MLL4100		MLL4693	4-2-74
MLL4101		MLL4694	4-2-74
MLL4102		MLL4695	4-2-74
MLL4103		MLL4696	4-2-74
MLL4104		MLL4697	4-2-74
MLL4105		MLL4698	4-2-74

CF = consult factory representative

CROSS-REFERENCE (continued)

Industry Part Number	Motorola Direct Replacement	Motorola Similar Replacement	Page Number
MLL4106		MLL4699	4-2-74
MLL4107		MLL4700	4-2-74
MLL4108		MLL4701	4-2-74
MLL4109		MLL4702	4-2-74
MLL4110		MLL4703	4-2-74
MLL4111		MLL4704	4-2-74
MLL4112		MLL4705	4-2-74
MLL4113		MLL4706	4-2-74
MLL4114		MLL4707	4-2-74
MLL4115		MLL4708	4-2-74
MLL4116		MLL4709	4-2-74
MLL4117		MLL4710	4-2-74
MLL4118		MLL4711	4-2-74
MLL4119		MLL4712	4-2-74
MLL4120		MLL4713	4-2-74
MLL4121		MLL4714	4-2-74
MLL4122		MLL4715	4-2-74
MLL4123		MLL4716	4-2-74
MLL4124		MLL4717	4-2-74
MLL4125		MMBZ5261BL	4-2-66
MLL4126		MMBZ5262BL	4-2-66
MLL4127		MMBZ5263BL	4-2-66
MLL4128		MMBZ5264BL	4-2-66
MLL4129		MMBZ5265BL	4-2-66
MLL4130		MMBZ5266BL	4-2-66
MLL4131		MMBZ5267BL	4-2-66
MLL4132		MMBZ5268BL	4-2-66
MLL4133		MMBZ5269BL	4-2-66
MLL4134		MMBZ5270BL	4-2-66
MLL4370A	MLL5221B		4-2-75
MLL4371A	MLL5223B		4-2-75
MLL4372A	MLL5225B		4-2-75
MLL4614		MLL4678	4-2-74
MLL4615		MLL4679	4-2-74
MLL4616		MLL4680	4-2-74
MLL4617		MLL4681	4-2-74
MLL4618		MLL4682	4-2-74
MLL4619		MLL4683	4-2-74
MLL4620		MLL4684	4-2-74
MLL4621		MLL4685	4-2-74
MLL4622		MLL4686	4-2-74
MLL4623		MLL4687	4-2-74
MLL4624		MLL4688	4-2-74
MLL4625		MLL4689	4-2-74
MLL4626		MLL4690	4-2-74
MLL4627		MLL4691	4-2-74
MLL4678	MLL4678		4-2-74
MLL4679	MLL4679		4-2-74
MLL4680	MLL4680		4-2-74
MLL4681	MLL4681		4-2-74
MLL4682	MLL4682		4-2-74

Industry Part Number	Motorola Direct Replacement	Motorola Similar Replacement	Page Number
MLL4683	MLL4683		4-2-74
MLL4684	MLL4684		4-2-74
MLL4685	MLL4685		4-2-74
MLL4686	MLL4686		4-2-74
MLL4687	MLL4687		4-2-74
MLL4688	MLL4688		4-2-74
MLL4689	MLL4689		4-2-74
MLL4690	MLL4690		4-2-74
MLL4691	MLL4691		4-2-74
MLL4692	MLL4692		4-2-74
MLL4693	MLL4693		4-2-74
MLL4694	MLL4694		4-2-74
MLL4695	MLL4695		4-2-74
MLL4696	MLL4696		4-2-74
MLL4697	MLL4697		4-2-74
MLL4698	MLL4698		4-2-74
MLL4699	MLL4699		4-2-74
MLL4700	MLL4700		4-2-74
MLL4701	MLL4701		4-2-74
MLL4702	MLL4702		4-2-74
MLL4703	MLL4703		4-2-74
MLL4704	MLL4704		4-2-74
MLL4705	MLL4705		4-2-74
MLL4706	MLL4706		4-2-74
MLL4707	MLL4707		4-2-74
MLL4708	MLL4708		4-2-74
MLL4709	MLL4709		4-2-74
MLL4710	MLL4710		4-2-74
MLL4711	MLL4711		4-2-74
MLL4712	MLL4712		4-2-74
MLL4713	MLL4713		4-2-74
MLL4714	MLL4714		4-2-74
MLL4715	MLL4715		4-2-74
MLL4716	MLL4716		4-2-74
MLL4717	MLL4717		4-2-74
MLL4728		1SMB5913BT3	4-2-78
MLL4728A		1SMB5913BT3	4-2-78
MLL4729		1SMB5914BT3	4-2-78
MLL4729A		1SMB5914BT3	4-2-78
MLL4730		1SMB5915BT3	4-2-78
MLL4730A		1SMB5915BT3	4-2-78
MLL4731		1SMB5916BT3	4-2-78
MLL4731A		1SMB5916BT3	4-2-78
MLL4732		1SMB5917BT3	4-2-78
MLL4732A		1SMB5917BT3	4-2-78
MLL4733		1SMB5918BT3	4-2-78
MLL4733A		1SMB5918BT3	4-2-78
MLL4734		1SMB5919BT3	4-2-78
MLL4734A		1SMB5919BT3	4-2-78
MLL4735		1SMB5920BT3	4-2-78
MLL4735A		1SMB5920BT3	4-2-78

CF = consult factory representative

CROSS-REFERENCE (continued)

Industry Part Number	Motorola Direct Replacement	Motorola Similar Replacement	Page Number
MLL4736		1SMB5921BT3	4-2-78
MLL4736A		1SMB5921BT3	4-2-78
MLL4737		1SMB5922BT3	4-2-78
MLL4737A		1SMB5922BT3	4-2-78
MLL4738		1SMB5923BT3	4-2-78
MLL4738A		1SMB5923BT3	4-2-78
MLL4739		1SMB5924BT3	4-2-78
MLL4739A		1SMB5924BT3	4-2-78
MLL4740		1SMB5925BT3	4-2-78
MLL4740A		1SMB5925BT3	4-2-78
MLL4741		1SMB5926BT3	4-2-78
MLL4741A		1SMB5926BT3	4-2-78
MLL4742		1SMB5927BT3	4-2-78
MLL4742A		1SMB5927BT3	4-2-78
MLL4743		1SMB5928BT3	4-2-78
MLL4743A		1SMB5928BT3	4-2-78
MLL4744		1SMB5929BT3	4-2-79
MLL4744A		1SMB5929BT3	4-2-79
MLL4745		1SMB5930BT3	4-2-79
MLL4745A		1SMB5930BT3	4-2-79
MLL4746		1SMB5931BT3	4-2-79
MLL4746A		1SMB5931BT3	4-2-79
MLL4747		1SMB5932BT3	4-2-79
MLL4747A		1SMB5932BT3	4-2-79
MLL4748		1SMB5933BT3	4-2-79
MLL4748A		1SMB5933BT3	4-2-79
MLL4749		1SMB5934BT3	4-2-79
MLL4749A		1SMB5934BT3	4-2-79
MLL4750		1SMB5935BT3	4-2-79
MLL4750A		1SMB5935BT3	4-2-79
MLL4751		1SMB5936BT3	4-2-79
MLL4751A		1SMB5936BT3	4-2-79
MLL4752		1SMB5937BT3	4-2-79
MLL4752A		1SMB5937BT3	4-2-79
MLL4753		1SMB5938BT3	4-2-79
MLL4753A		1SMB5938BT3	4-2-79
MLL4754		1SMB5939BT3	4-2-79
MLL4754A		1SMB5939BT3	4-2-79
MLL4755		1SMB5940BT3	4-2-79
MLL4755A		1SMB5940BT3	4-2-79
MLL4756		1SMB5941BT3	4-2-79
MLL4756A		1SMB5941BT3	4-2-79
MLL4757		1SMB5942BT3	4-2-79
MLL4757A		1SMB5942BT3	4-2-79
MLL4758		1SMB5943BT3	4-2-79
MLL4758A		1SMB5943BT3	4-2-79
MLL4759		1SMB5944BT3	4-2-79
MLL4759A		1SMB5944BT3	4-2-79
MLL4760		1SMB5945BT3	4-2-79
MLL4760A		1SMB5945BT3	4-2-79
MLL4761		1SMB5946BT3	4-2-79

Industry Part Number	Motorola Direct Replacement	Motorola Similar Replacement	Page Number
MLL4761A		1SMB5946BT3	4-2-79
MLL4762		1SMB5947BT3	4-2-79
MLL4762A		1SMB5947BT3	4-2-79
MLL4763		1SMB5948BT3	4-2-79
MLL4763A		1SMB5948BT3	4-2-79
MLL4764		1SMB5949BT3	4-2-79
MLL4764A		1SMB5949BT3	4-2-79
MLL5221B	MLL5221B		4-2-75
MLL5222B	MLL5222B		4-2-75
MLL5223B	MLL5223B		4-2-75
MLL5224B	MLL5224B		4-2-75
MLL5225B	MLL5225B		4-2-75
MLL5226B	MLL5226B		4-2-75
MLL5227B	MLL5227B		4-2-75
MLL5228B	MLL5228B		4-2-75
MLL5229B	MLL5229B		4-2-75
MLL5230B	MLL5230B		4-2-75
MLL5231B	MLL5231B		4-2-75
MLL5232B	MLL5232B		4-2-75
MLL5233B	MLL5233B		4-2-75
MLL5234B	MLL5234B		4-2-75
MLL5235B	MLL5235B		4-2-75
MLL5236B	MLL5236B		4-2-75
MLL5237B	MLL5237B		4-2-75
MLL5238B	MLL5238B		4-2-75
MLL5239B	MLL5239B		4-2-75
MLL5240B	MLL5240B		4-2-75
MLL5241B	MLL5241B		4-2-75
MLL5242B	MLL5242B		4-2-75
MLL5243B	MLL5243B		4-2-75
MLL5244B	MLL5244B		4-2-75
MLL5245B	MLL5245B		4-2-75
MLL5246B	MLL5246B		4-2-75
MLL5247B	MLL5247B		4-2-75
MLL5248B	MLL5248B		4-2-75
MLL5249B	MLL5249B		4-2-75
MLL5250B	MLL5250B		4-2-75
MLL5251B	MLL5251B		4-2-75
MLL5252B	MLL5252B		4-2-75
MLL5253B	MLL5253B		4-2-75
MLL5254B	MLL5254B		4-2-75
MLL5255B	MLL5255B		4-2-75
MLL5256B	MLL5256B		4-2-75
MLL5257B	MLL5257B		4-2-75
MLL5258B	MLL5258B		4-2-75
MLL5259B	MLL5259B		4-2-75
MLL5260B	MLL5260B		4-2-75
MLL5261B	MLL5261B		4-2-75
MLL5262B	MLL5262B		4-2-75
MLL5263B	MLL5263B		4-2-75
MLL5264B		MMBZ5264BL	4-2-66

CF = consult factory representative

CROSS-REFERENCE (continued)

Industry Part Number	Motorola Direct Replacement	Motorola Similar Replacement	Page Number
MLL5265B		MMBZ5265BL	4-2-66
MLL5266B		MMBZ5266BL	4-2-66
MLL5267B		MMBZ5267BL	4-2-66
MLL5268B		MMBZ5268BL	4-2-66
MLL5269B		MMBZ5269BL	4-2-66
MLL5270B		MMBZ5270BL	4-2-66
MLL5913A,B		1SMB5913BT3	4-2-78
MLL5914A,B		1SMB5914BT3	4-2-78
MLL5915A,B		1SMB5915BT3	4-2-78
MLL5916A,B		1SMB5916BT3	4-2-78
MLL5917A,B		1SMB5917BT3	4-2-78
MLL5918A,B		1SMB5918BT3	4-2-78
MLL5919A,B		1SMB5919BT3	4-2-78
MLL5920A,B		1SMB5920BT3	4-2-78
MLL5921A,B		1SMB5921BT3	4-2-78
MLL5922A,B		1SMB5922BT3	4-2-78
MLL5923A,B		1SMB5923BT3	4-2-78
MLL5924A,B		1SMB5924BT3	4-2-78
MLL5925A,B		1SMB5925BT3	4-2-78
MLL5926A,B		1SMB5926BT3	4-2-78
MLL5927A,B		1SMB5927BT3	4-2-78
MLL5928A,B		1SMB5928BT3	4-2-78
MLL5929A,B		1SMB5929BT3	4-2-79
MLL5930A,B		1SMB5930BT3	4-2-79
MLL5931A,B		1SMB5931BT3	4-2-79
MLL5932A,B		1SMB5932BT3	4-2-79
MLL5933A,B		1SMB5933BT3	4-2-79
MLL5934A,B		1SMB5934BT3	4-2-79
MLL5935A,B		1SMB5935BT3	4-2-79
MLL5936A,B		1SMB5936BT3	4-2-79
MLL5937A,B		1SMB5937BT3	4-2-79
MLL5938A,B		1SMB5938BT3	4-2-79
MLL5939A,B		1SMB5939BT3	4-2-79
MLL5940A,B		1SMB5940BT3	4-2-79
MLL5941A,B		1SMB5941BT3	4-2-79
MLL5942A,B		1SMB5942BT3	4-2-79
MLL5943A,B		1SMB5943BT3	4-2-79
MLL5944A,B		1SMB5944BT3	4-2-79
MLL5945A,B		1SMB5945BT3	4-2-79
MLL5946A,B		1SMB5946BT3	4-2-79
MLL5947A,B		1SMB5947BT3	4-2-79
MLL5948A,B		1SMB5948BT3	4-2-79
MLL5949A,B		1SMB5949BT3	4-2-79
MLL5950A,B		1SMB5950BT3	4-2-79
MLL5951A,B		1SMB5951BT3	4-2-79
MLL5952A,B		1SMB5952BT3	4-2-79
MLL5953A,B		1SMB5953BT3	4-2-79
MLL5954A,B		1SMB5954BT3	4-2-79
MLL5955A,B		1SMB5955BT3	4-2-79
MLL5956A,B		1SMB5956BT3	4-2-79
MLL746A	MLL5226B		4-2-75

Industry Part Number	Motorola Direct Replacement	Motorola Similar Replacement	Page Number
MLL747A	MLL5227B		4-2-75
MLL748A	MLL5228B		4-2-75
MLL749A	MLL5229B		4-2-75
MLL750A	MLL5230B		4-2-75
MLL751A	MLL5231B		4-2-75
MLL752A	MLL5232B		4-2-75
MLL753A	MLL5234B		4-2-75
MLL754A	MLL5235B		4-2-75
MLL755A	MLL5236B		4-2-75
MLL756A	MLL5237B		4-2-75
MLL757A	MLL5239B		4-2-75
MLL758A	MLL5240B		4-2-75
MLL759A	MLL5242B		4-2-75
MLL957B		MLL5235B	4-2-75
MLL958B		MLL5236B	4-2-75
MLL959B		MLL5237B	4-2-75
MLL960B		MLL5239B	4-2-75
MLL961B		MLL5240B	4-2-75
MLL962B	MLL5241B		4-2-75
MLL963B		MLL5242B	4-2-75
MLL964B	MLL5243B		4-2-75
MLL965B	MLL5245B		4-2-75
MLL966B	MLL5246B		4-2-75
MLL967B	MLL5248B		4-2-75
MLL968B	MLL5250B		4-2-75
MLL969B	MLL5251B		4-2-75
MLL970B	MLL5252B		4-2-75
MLL971B	MLL5254B		4-2-75
MLL972B	MLL5256B		4-2-75
MLL973B	MLL5257B		4-2-75
MLL974B	MLL5258B		4-2-75
MLL975B	MLL5259B		4-2-75
MLL976B	MLL5260B		4-2-75
MLL977B	MLL5261B		4-2-75
MLL978B	MLL5262B		4-2-75
MLL979B	MLL5263B		4-2-75
MLL980B		MMBZ5265BL	4-2-66
MLL981B		MMBZ5266BL	4-2-66
MLL982B		MMBZ5267BL	4-2-66
MLL983B		MMBZ5268BL	4-2-66
MLL984B		MMBZ5270BL	4-2-66
MMBZ15VDLT1	MMBZ15VDLT1		4-1-52
MMBZ5221BL	MMBZ5221BL		4-2-66
MMBZ5222BL	MMBZ5222BL		4-2-66
MMBZ5223BL	MMBZ5223BL		4-2-66
MMBZ5224BL	MMBZ5224BL		4-2-66
MMBZ5225BL	MMBZ5225BL		4-2-66
MMBZ5226BL	MMBZ5226BL		4-2-66
MMBZ5227BL	MMBZ5227BL		4-2-66
MMBZ5228BL	MMBZ5228BL		4-2-66
MMBZ5229BL	MMBZ5229BL		4-2-66



CF = consult factory representative

CROSS-REFERENCE (continued)

Industry Part Number	Motorola Direct Replacement	Motorola Similar Replacement	Page Number
MMBZ5230BL	MMBZ5230BL		4-2-66
MMBZ5231BL	MMBZ5231BL		4-2-66
MMBZ5232BL	MMBZ5232BL		4-2-66
MMBZ5233BL	MMBZ5233BL		4-2-66
MMBZ5234BL	MMBZ5234BL		4-2-66
MMBZ5235BL	MMBZ5235BL		4-2-66
MMBZ5236BL	MMBZ5236BL		4-2-66
MMBZ5237BL	MMBZ5237BL		4-2-66
MMBZ5238BL	MMBZ5238BL		4-2-66
MMBZ5239BL	MMBZ5239BL		4-2-66
MMBZ5240BL	MMBZ5240BL		4-2-66
MMBZ5241BL	MMBZ5241BL		4-2-66
MMBZ5242BL	MMBZ5242BL		4-2-66
MMBZ5243BL	MMBZ5243BL		4-2-66
MMBZ5244BL	MMBZ5244BL		4-2-66
MMBZ5245BL	MMBZ5245BL		4-2-66
MMBZ5246BL	MMBZ5246BL		4-2-66
MMBZ5247BL	MMBZ5247BL		4-2-66
MMBZ5248BL	MMBZ5248BL		4-2-66
MMBZ5249BL	MMBZ5249BL		4-2-66
MMBZ5250BL	MMBZ5250BL		4-2-66
MMBZ5251BL	MMBZ5251BL		4-2-66
MMBZ5252BL	MMBZ5252BL		4-2-66
MMBZ5253BL	MMBZ5253BL		4-2-66
MMBZ5254BL	MMBZ5254BL		4-2-66
MMBZ5255BL	MMBZ5255BL		4-2-66
MMBZ5256BL	MMBZ5256BL		4-2-66
MMBZ5257BL	MMBZ5257BL		4-2-66
MMBZ5258BL	MMBZ5258BL		4-2-66
MMBZ5259BL	MMBZ5259BL		4-2-66
MMBZ5260BL	MMBZ5260BL		4-2-66
MMBZ5261BL	MMBZ5261BL		4-2-66
MMBZ5262BL	MMBZ5262BL		4-2-66
MMBZ5263BL	MMBZ5263BL		4-2-66
MMBZ5264BL	MMBZ5264BL		4-2-66
MMBZ5265BL	MMBZ5265BL		4-2-66
MMBZ5266BL	MMBZ5266BL		4-2-66
MMBZ5267BL	MMBZ5267BL		4-2-66
MMBZ5268BL	MMBZ5268BL		4-2-66
MMBZ5269BL	MMBZ5269BL		4-2-66
MMBZ5270BL	MMBZ5270BL		4-2-66
MPT-10		MPTE-10	4-1-46
MPT-10C		MPTE-10C	4-1-46
MPT-12		MPTE-12	4-1-46
MPT-12C		MPTE-12C	4-1-46
MPT-15		MPTE-15	4-1-46
MPT-15C		MPTE-15C	4-1-46
MPT-18		MPTE-18	4-1-46
MPT-18C		MPTE-18C	4-1-46
MPT-22		MPTE-22	4-1-46
MPT-22C		MPTE-22C	4-1-46

Industry Part Number	Motorola Direct Replacement	Motorola Similar Replacement	Page Number
MPT-36		MPTE-36	4-1-46
MPT-36C		MPTE-36C	4-1-46
MPT-45		MPTE-45	4-1-46
MPT-45C		MPTE-45C	4-1-46
MPT-5		MPTE-5	4-1-46
MPT-8		MPTE-8	4-1-46
MPT-8C		MPTE-8C	4-1-46
MPT-10	MPTE-10		4-1-46
MPT-10C	MPTE-10C		4-1-46
MPT-12	MPTE-12		4-1-46
MPT-12C	MPTE-12C		4-1-46
MPT-15	MPTE-15		4-1-46
MPT-15C	MPTE-15C		4-1-46
MPT-18	MPTE-18		4-1-46
MPT-18C	MPTE-18C		4-1-46
MPT-22	MPTE-22		4-1-46
MPT-22C	MPTE-22C		4-1-46
MPT-36	MPTE-36		4-1-46
MPT-36C	MPTE-36C		4-1-46
MPT-45	MPTE-45		4-1-46
MPT-45C	MPTE-45C		4-1-46
MPT-5	MPTE-5		4-1-46
MPT-8	MPTE-8		4-1-46
MPT-8C	MPTE-8C		4-1-46
MR2535L	MR2535L		4-1-48
MZ1000-1	1N4728		4-2-44
MZ1000-10	1N4737		4-2-44
MZ1000-11	1N4738		4-2-44
MZ1000-12	1N4739		4-2-44
MZ1000-13	1N4740		4-2-44
MZ1000-14	1N4741		4-2-44
MZ1000-15	1N4742		4-2-44
MZ1000-16	1N4743		4-2-44
MZ1000-17	1N4744		4-2-44
MZ1000-18	1N4745		4-2-44
MZ1000-19	1N4746		4-2-44
MZ1000-2	1N4729		4-2-44
MZ1000-20	1N4747		4-2-44
MZ1000-21	1N4748		4-2-44
MZ1000-22	1N4749		4-2-44
MZ1000-23	1N4750		4-2-44
MZ1000-24	1N4751		4-2-44
MZ1000-25	1N4752		4-2-44
MZ1000-26	1N4753		4-2-44
MZ1000-27	1N4754		4-2-44
MZ1000-28	1N4755		4-2-44
MZ1000-29	1N4756		4-2-44
MZ1000-3	1N4730		4-2-44
MZ1000-30	1N4757		4-2-44
MZ1000-31	1N4758		4-2-44
MZ1000-32	1N4759		4-2-44

CF = consult factory representative

CROSS-REFERENCE (continued)

Industry Part Number	Motorola Direct Replacement	Motorola Similar Replacement	Page Number
MZ1000-33	1N4760		4-2-44
MZ1000-34	1N4761		4-2-44
MZ1000-35	1N4762		4-2-44
MZ1000-36	1N4763		4-2-44
MZ1000-37	1N4764		4-2-44
MZ1000-4	1N4731		4-2-44
MZ1000-5	1N4732		4-2-44
MZ1000-6	1N4733		4-2-44
MZ1000-7	1N4734		4-2-44
MZ1000-8	1N4735		4-2-44
MZ1000-9	1N4736		4-2-44
MZ4099	MZ4099		4-2-37
MZ4100	MZ4100		4-2-37
MZ4101	MZ4101		4-2-37
MZ4102	MZ4102		4-2-37
MZ4103	MZ4103		4-2-37
MZ4104	MZ4104		4-2-37
MZ4614	MZ4614		4-2-37
MZ4615	MZ4615		4-2-37
MZ4616	MZ4616		4-2-37
MZ4617	MZ4617		4-2-37
MZ4618	MZ4618		4-2-37
MZ4619	MZ4619		4-2-37
MZ4620	MZ4620		4-2-37
MZ4621	MZ4621		4-2-37
MZ4622	MZ4622		4-2-37
MZ4623	MZ4623		4-2-37
MZ4624	MZ4624		4-2-37
MZ4625	MZ4625		4-2-37
MZ4626	MZ4626		4-2-37
MZ4627	MZ4627		4-2-37
MZ4678	1N4678		4-2-30
MZ4679	1N4679		4-2-30
MZ4680	1N4680		4-2-30
MZ4681	1N4681		4-2-30
MZ4682	1N4682		4-2-30
MZ4683	1N4683		4-2-30
MZ4684	1N4684		4-2-30
MZ4685	1N4685		4-2-30
MZ4686	1N4686		4-2-30
MZ4687	1N4687		4-2-30
MZ4688	1N4688		4-2-30
MZ4689	1N4689		4-2-30
MZ4690	1N4690		4-2-30
MZ4691	1N4691		4-2-30
MZ4692	1N4692		4-2-30
MZ4693	1N4693		4-2-30
MZ4694	1N4694		4-2-30
MZ4695	1N4695		4-2-30
MZ4696	1N4696		4-2-30
MZ4697	1N4697		4-2-30

Industry Part Number	Motorola Direct Replacement	Motorola Similar Replacement	Page Number
MZ4698	1N4698		4-2-30
MZ4699	1N4699		4-2-30
MZ4700	1N4700		4-2-30
MZ4701	1N4701		4-2-30
MZ4702	1N4702		4-2-30
MZ4703	1N4703		4-2-30
MZ4704	1N4704		4-2-30
MZ4705	1N4705		4-2-30
MZ4706	1N4706		4-2-30
MZ4707	1N4707		4-2-30
MZ4708	1N4708		4-2-30
MZ4709	1N4709		4-2-30
MZ4710	1N4710		4-2-30
MZ4711	1N4711		4-2-30
MZ4712	1N4712		4-2-30
MZ4713	1N4713		4-2-30
MZ4714	1N4714		4-2-30
MZ4715	1N4715		4-2-30
MZ4716	1N4716		4-2-30
MZ4717	1N4717		4-2-30
MZ500-1	1N5221A		4-2-31
MZ500-10	1N5232A		4-2-31
MZ500-11	1N5234A		4-2-31
MZ500-12	1N5235A		4-2-31
MZ500-13	1N5236A		4-2-31
MZ500-14	1N5237A		4-2-31
MZ500-15	1N5239A		4-2-31
MZ500-16	1N5240A		4-2-31
MZ500-17	1N5241A		4-2-31
MZ500-18	1N5242A		4-2-31
MZ500-19	1N5243A		4-2-31
MZ500-2	1N5223A		4-2-31
MZ500-20	1N5245A		4-2-31
MZ500-21	1N5246A		4-2-31
MZ500-22	1N5248A		4-2-31
MZ500-23	1N5250A		4-2-31
MZ500-24	1N5251A		4-2-31
MZ500-25	1N5252A		4-2-31
MZ500-26	1N5254A		4-2-31
MZ500-27	1N5256A		4-2-31
MZ500-28	1N5257A		4-2-31
MZ500-29	1N5258A		4-2-31
MZ500-3	1N5225A		4-2-31
MZ500-30	1N5259A		4-2-31
MZ500-31	1N5260A		4-2-31
MZ500-32	1N5261A		4-2-31
MZ500-33	1N5262A		4-2-31
MZ500-34	1N5263A		4-2-31
MZ500-35	1N5265A		4-2-31
MZ500-36	1N5266A		4-2-32
MZ500-37	1N5267A		4-2-32

CF = consult factory representative



CROSS-REFERENCE (continued)

2

Industry Part Number	Motorola Direct Replacement	Motorola Similar Replacement	Page Number
MZ500-38	1N5268A		4-2-32
MZ500-39	1N5270A		4-2-32
MZ500-4	1N5226A		4-2-31
MZ500-40	1N5271A		4-2-32
MZ500-5	1N5227A		4-2-31
MZ500-6	1N5228A		4-2-31
MZ500-7	1N5229A		4-2-31
MZ500-8	1N5230A		4-2-31
MZ500-9	1N5231A		4-2-31
MZ5520B	MZ5520B		4-2-38
MZ5521B	MZ5521B		4-2-38
MZ5522B	MZ5522B		4-2-38
MZ5523B	MZ5523B		4-2-38
MZ5524B	MZ5524B		4-2-38
MZ5525B	MZ5525B		4-2-38
MZ5526B	MZ5526B		4-2-38
MZ5527B	MZ5527B		4-2-38
MZ5528B	MZ5528B		4-2-38
MZ5529B	MZ5529B		4-2-38
MZ5530B	MZ5530B		4-2-38
MZ5555		1N6284A	4-1-43
MZ5556		1N6287A	4-1-43
MZ5557		1N6289A	4-1-44
MZ5558		1N6303A	4-1-44
MZ623-10		1N4744A	4-2-44
MZ623-10A		1N4744A	4-2-44
MZ623-10B		1N4744A	4-2-44
MZ623-11		1N4745A	4-2-44
MZ623-11A		1N4745A	4-2-44
MZ623-11B		1N4745A	4-2-44
MZ623-12		1N4746A	4-2-44
MZ623-12A		1N4746A	4-2-44
MZ623-12B		1N4746A	4-2-44
MZ623-13		1N4746A	4-2-44
MZ623-13A		1N4746A	4-2-44
MZ623-13B		1N4746A	4-2-44
MZ623-14		1N4747A	4-2-44
MZ623-14A		1N4747A	4-2-44
MZ623-14B		1N4747A	4-2-44
MZ623-15		1N4747A	4-2-44
MZ623-15A		1N4747A	4-2-44
MZ623-15B		1N4747A	4-2-44
MZ623-16		1N4748A	4-2-44
MZ623-16A		1N4748A	4-2-44
MZ623-16B		1N4748A	4-2-44
MZ623-17		1N4749A	4-2-44
MZ623-17A		1N4749A	4-2-44
MZ623-17B		1N4749A	4-2-44
MZ623-18		1N4749A	4-2-44
MZ623-18A		1N4749A	4-2-44
MZ623-18B		1N4749A	4-2-44

Industry Part Number	Motorola Direct Replacement	Motorola Similar Replacement	Page Number
MZ623-19		1N4750A	4-2-44
MZ623-19A		1N4750A	4-2-44
MZ623-19B		1N4750A	4-2-44
MZ623-20		1N4751A	4-2-44
MZ623-20A		1N4751A	4-2-44
MZ623-20B		1N4751A	4-2-44
MZ623-21		1N4752A	4-2-44
MZ623-21A		1N4752A	4-2-44
MZ623-21B		1N4752A	4-2-44
MZ623-22		1N4753A	4-2-44
MZ623-22A		1N4753A	4-2-44
MZ623-22B		1N4753A	4-2-44
MZ623-23		1N4754A	4-2-44
MZ623-23A		1N4754A	4-2-44
MZ623-23B		1N4754A	4-2-44
MZ623-24		1N4755A	4-2-44
MZ623-24A		1N4755A	4-2-44
MZ623-24B		1N4755A	4-2-44
MZ623-25		1N4756A	4-2-44
MZ623-25A		1N4756A	4-2-44
MZ623-25B		1N4756A	4-2-44
MZ623-26		1N4756A	4-2-44
MZ623-26A		1N4756A	4-2-44
MZ623-26B		1N4756A	4-2-44
MZ623-27		1N4757A	4-2-44
MZ623-27A		1N4757A	4-2-44
MZ623-27B		1N4757A	4-2-44
MZ623-6		1N4741A	4-2-44
MZ623-6A		1N4741A	4-2-44
MZ623-6B		1N4741A	4-2-44
MZ623-7		1N4742A	4-2-44
MZ623-7A		1N4742A	4-2-44
MZ623-7B		1N4742A	4-2-44
MZ623-8		1N4743A	4-2-44
MZ623-8A		1N4743A	4-2-44
MZ623-8B		1N4743A	4-2-44
MZ623-9		1N4744A	4-2-44
MZ623-9A		1N4744A	4-2-44
MZ623-9B		1N4744A	4-2-44
MZ70-100B	1N5271B		4-2-32
MZ70-10B	1N5240B		4-2-31
MZ70-110B	1N5272B		4-2-32
MZ70-11B	1N5241B		4-2-31
MZ70-120B	1N5273B		4-2-32
MZ70-12B	1N5242B		4-2-31
MZ70-130B	1N5274B		4-2-32
MZ70-13B	1N5243B		4-2-31
MZ70-140B	1N5275B		4-2-32
MZ70-14B	1N5244B		4-2-31
MZ70-150B	1N5276B		4-2-32
MZ70-15B	1N5245B		4-2-31

CF = consult factory representative

CROSS-REFERENCE (continued)

Industry Part Number	Motorola Direct Replacement	Motorola Similar Replacement	Page Number	Industry Part Number	Motorola Direct Replacement	Motorola Similar Replacement	Page Number
MZ70-160B	1N5277B		4-2-32	MZ92-110B		1N5272B	4-2-32
MZ70-16B	1N5246B		4-2-31	MZ92-11B		1N5241B	4-2-31
MZ70-170B	1N5278B		4-2-32	MZ92-120B		1N5273B	4-2-32
MZ70-17B	1N5247B		4-2-31	MZ92-12B		1N5242B	4-2-31
MZ70-180B	1N5279B		4-2-32	MZ92-130B		1N5274B	4-2-32
MZ70-18B	1N5248B		4-2-31	MZ92-13B		1N5243B	4-2-31
MZ70-190B	1N5280B		4-2-32	MZ92-140B		1N5275B	4-2-32
MZ70-19B	1N5249B		4-2-31	MZ92-14B		1N5244B	4-2-31
MZ70-2.4B	1N5221B		4-2-31	MZ92-150B		1N5276B	4-2-32
MZ70-2.5B	1N5222B		4-2-31	MZ92-15B		1N5245B	4-2-31
MZ70-2.7B	1N5223B		4-2-31	MZ92-160B		1N5277B	4-2-32
MZ70-2.8B	1N5224B		4-2-31	MZ92-16B		1N5246B	4-2-31
MZ70-200B	1N5281B		4-2-32	MZ92-170B		1N5278B	4-2-32
MZ70-20B	1N5250B		4-2-31	MZ92-17B		1N5247B	4-2-31
MZ70-22B	1N5251B		4-2-31	MZ92-180B		1N5279B	4-2-32
MZ70-24B	1N5252B		4-2-31	MZ92-18B		1N5248B	4-2-31
MZ70-25B	1N5253B		4-2-31	MZ92-190B		1N5280B	4-2-32
MZ70-27B	1N5254B		4-2-31	MZ92-19B		1N5249B	4-2-31
MZ70-28B	1N5255B		4-2-31	MZ92-2.4B		1N5221B	4-2-31
MZ70-3.3B	1N5226B		4-2-31	MZ92-2.5B		1N5222B	4-2-31
MZ70-3.6B	1N5227B		4-2-31	MZ92-2.7B		1N5223B	4-2-31
MZ70-3.9B	1N5228B		4-2-31	MZ92-2.8B		1N5224B	4-2-31
MZ70-30B	1N5256B		4-2-31	MZ92-200B		1N5281B	4-2-32
MZ70-33B	1N5257B		4-2-31	MZ92-20B		1N5250B	4-2-31
MZ70-36B	1N5258B		4-2-31	MZ92-22B		1N5251B	4-2-31
MZ70-39B	1N5259B		4-2-31	MZ92-24B		1N5252B	4-2-31
MZ70-3B	1N5225B		4-2-31	MZ92-25B		1N5253B	4-2-31
MZ70-4.3B	1N5229B		4-2-31	MZ92-27B		1N5254B	4-2-31
MZ70-4.7B	1N5230B		4-2-31	MZ92-28B		1N5255B	4-2-31
MZ70-43B	1N5260B		4-2-31	MZ92-3.3B		1N5226B	4-2-31
MZ70-47B	1N5261B		4-2-31	MZ92-3.6B		1N5227B	4-2-31
MZ70-5.1B	1N5231B		4-2-31	MZ92-3.9B		1N5228B	4-2-31
MZ70-5.6B	1N5232B		4-2-31	MZ92-30B		1N5256B	4-2-31
MZ70-51B	1N5262B		4-2-31	MZ92-33B		1N5257B	4-2-31
MZ70-56B	1N5263B		4-2-31	MZ92-36B		1N5258B	4-2-31
MZ70-6.2B	1N5234B		4-2-31	MZ92-39B		1N5259B	4-2-31
MZ70-6.8B	1N5235B		4-2-31	MZ92-3B		1N5225B	4-2-31
MZ70-60B	1N5264B		4-2-31	MZ92-4.3B		1N5229B	4-2-31
MZ70-62B	1N5265B		4-2-31	MZ92-4.7B		1N5230B	4-2-31
MZ70-68B	1N5266B		4-2-32	MZ92-43B		1N5260B	4-2-31
MZ70-6B	1N5233B		4-2-31	MZ92-47B		1N5261B	4-2-31
MZ70-7.5B	1N5236B		4-2-31	MZ92-5.1B		1N5231B	4-2-31
MZ70-75B	1N5267B		4-2-32	MZ92-5.6B		1N5232B	4-2-31
MZ70-8.2B	1N5237B		4-2-31	MZ92-51B		1N5262B	4-2-31
MZ70-8.7B	1N5238B		4-2-31	MZ92-56B		1N5263B	4-2-31
MZ70-82B	1N5268B		4-2-32	MZ92-6.2B		1N5234B	4-2-31
MZ70-87B	1N5269B		4-2-32	MZ92-6.8B		1N5235B	4-2-31
MZ70-9.1B	1N5239B		4-2-31	MZ92-60B		1N5264B	4-2-31
MZ70-91B	1N5270B		4-2-32	MZ92-62B		1N5265B	4-2-31
MZ92-100B		1N5271B	4-2-32	MZ92-68B		1N5266B	4-2-32
MZ92-10B		1N5240B	4-2-31	MZ92-6B		1N5233B	4-2-31

CF = consult factory representative



CROSS-REFERENCE (continued)

2

Industry Part Number	Motorola Direct Replacement	Motorola Similar Replacement	Page Number
MZ92-7.5B		1N5236B	4-2-31
MZ92-75B		1N5267B	4-2-32
MZ92-8.2B		1N5237B	4-2-31
MZ92-8.7B		1N5238B	4-2-31
MZ92-82B		1N5268B	4-2-32
MZ92-87B		1N5269B	4-2-32
MZ92-9.1B		1N5239B	4-2-31
MZ92-91B		1N5270B	4-2-32
MZD10	MZD10		4-2-55
MZD100	MZD100		4-2-55
MZD11	MZD11		4-2-55
MZD110	MZD110		4-2-55
MZD12	MZD12		4-2-55
MZD120	MZD120		4-2-55
MZD13	MZD13		4-2-55
MZD130	MZD130		4-2-55
MZD15	MZD15		4-2-55
MZD150	MZD150		4-2-55
MZD16	MZD16		4-2-55
MZD160	MZD160		4-2-55
MZD18	MZD18		4-2-55
MZD180	MZD180		4-2-55
MZD20	MZD20		4-2-55
MZD200	MZD200		4-2-55
MZD22	MZD22		4-2-55
MZD24	MZD24		4-2-55
MZD27	MZD27		4-2-55
MZD3.9	MZD3.9		4-2-55
MZD30	MZD30		4-2-55
MZD33	MZD33		4-2-55
MZD36	MZD36		4-2-55
MZD39	MZD39		4-2-55
MZD4.3	MZD4.3		4-2-55
MZD4.7	MZD4.7		4-2-55
MZD43	MZD43		4-2-55
MZD47	MZD47		4-2-55
MZD5.1	MZD5.1		4-2-55
MZD5.6	MZD5.6		4-2-55
MZD51	MZD51		4-2-55
MZD56	MZD56		4-2-55
MZD6.2	MZD6.2		4-2-55
MZD6.8	MZD6.8		4-2-55
MZD62	MZD62		4-2-55
MZD68	MZD68		4-2-55
MZD7.5	MZD7.5		4-2-55
MZD75	MZD75		4-2-55
MZD8.2	MZD8.2		4-2-55
MZD82	MZD82		4-2-55
MZD9.1	MZD9.1		4-2-55
MZD91	MZD91		4-2-55
MZP4728A	MZP4728A		4-2-56

Industry Part Number	Motorola Direct Replacement	Motorola Similar Replacement	Page Number
MZP4729A	MZP4729A		4-2-56
MZP4730A	MZP4730A		4-2-56
MZP4731A	MZP4731A		4-2-56
MZP4732A	MZP4732A		4-2-56
MZP4733A	MZP4733A		4-2-56
MZP4734A	MZP4734A		4-2-56
MZP4735A	MZP4735A		4-2-56
MZP4736A	MZP4736A		4-2-56
MZP4737A	MZP4737A		4-2-56
MZP4738A	MZP4738A		4-2-56
MZP4739A	MZP4739A		4-2-56
MZP4740A	MZP4740A		4-2-56
MZP4741A	MZP4741A		4-2-56
MZP4742A	MZP4742A		4-2-56
MZP4743A	MZP4743A		4-2-56
MZP4744A	MZP4744A		4-2-56
MZP4745A	MZP4745A		4-2-56
MZP4746A	MZP4746A		4-2-56
MZP4747A	MZP4747A		4-2-56
MZP4748A	MZP4748A		4-2-56
MZP4749A	MZP4749A		4-2-56
MZP4750A	MZP4750A		4-2-56
MZP4751A	MZP4751A		4-2-56
MZP4752A	MZP4752A		4-2-56
MZP4753A	MZP4753A		4-2-56
MZP4754A	MZP4754A		4-2-56
MZP4755A	MZP4755A		4-2-56
MZP4756A	MZP4756A		4-2-56
MZP4757A	MZP4757A		4-2-56
MZP4758A	MZP4758A		4-2-56
MZP4759A	MZP4759A		4-2-56
MZP4760A	MZP4760A		4-2-56
MZP4761A	MZP4761A		4-2-56
MZP4762A	MZP4762A		4-2-56
MZP4763A	MZP4763A		4-2-56
MZP4764A	MZP4764A		4-2-56
MZPY10	MZPY10		4-2-46
MZPY100	MZPY100		4-2-46
MZPY11	MZPY11		4-2-46
MZPY12	MZPY12		4-2-46
MZPY13	MZPY13		4-2-46
MZPY15	MZPY15		4-2-46
MZPY16	MZPY16		4-2-46
MZPY18	MZPY18		4-2-46
MZPY20	MZPY20		4-2-46
MZPY22	MZPY22		4-2-46
MZPY24	MZPY24		4-2-46
MZPY27	MZPY27		4-2-46
MZPY3.9	MZPY3.9		4-2-46
MZPY30	MZPY30		4-2-46
MZPY33	MZPY33		4-2-46

CF = consult factory representative

CROSS-REFERENCE (continued)

Industry Part Number	Motorola Direct Replacement	Motorola Similar Replacement	Page Number
MZPY36	MZPY36		4-2-46
MZPY39	MZPY39		4-2-46
MZPY4.3	MZPY4.3		4-2-46
MZPY4.7	MZPY4.7		4-2-46
MZPY43	MZPY43		4-2-46
MZPY47	MZPY47		4-2-46
MZPY5.1	MZPY5.1		4-2-46
MZPY5.6	MZPY5.6		4-2-46
MZPY51	MZPY51		4-2-46
MZPY56	MZPY56		4-2-46
MZPY6.2	MZPY6.2		4-2-46
MZPY6.8	MZPY6.8		4-2-46
MZPY62	MZPY62		4-2-46
MZPY68	MZPY68		4-2-46
MZPY7.5	MZPY7.5		4-2-46
MZPY75	MZPY75		4-2-46
MZPY8.2	MZPY8.2		4-2-46
MZPY82	MZPY82		4-2-46
MZPY9.1	MZPY9.1		4-2-46
MZPY91	MZPY91		4-2-46
P5KE100A		P6KE120A	4-1-34
P5KE100CA		P6KE120CA	4-1-34
P5KE10A		P6KE12A	4-1-33
P5KE10CA		P6KE12CA	4-1-33
P5KE110A		P6KE130A	4-1-34
P5KE110CA		P6KE130CA	4-1-34
P5KE11A		P6KE13A	4-1-33
P5KE11CA		P6KE13CA	4-1-33
P5KE120A		P6KE150A	4-1-34
P5KE120CA		P6KE150CA	4-1-34
P5KE12A		P6KE15A	4-1-33
P5KE12CA		P6KE15CA	4-1-33
P5KE130A		P6KE160	4-1-34
P5KE130CA		P6KE160CA	4-1-34
P5KE13A		P6KE15A	4-1-33
P5KE13CA		P6KE15CA	4-1-33
P5KE14A		P6KE18A	4-1-33
P5KE14CA		P6KE18CA	4-1-33
P5KE150A		P6KE180A	4-1-34
P5KE150CA		P6KE180CA	4-1-34
P5KE15A		P6KE18A	4-1-33
P5KE15CA		P6KE18CA	4-1-33
P5KE160A		P6KE200A	4-1-34
P5KE160CA		P6KE200CA	4-1-34
P5KE16A		P6KE20A	4-1-33
P5KE16CA		P6KE20CA	4-1-33
P5KE170A		P6KE200A	4-1-34
P5KE170CA		P6KE200CA	4-1-34
P5KE17A		P6KE20A	4-1-33
P5KE17CA		P6KE20CA	4-1-33
P5KE18A		P6KE22A	4-1-33

Industry Part Number	Motorola Direct Replacement	Motorola Similar Replacement	Page Number
P5KE18CA		P6KE22CA	4-1-33
P5KE20A		P6KE24A	4-1-33
P5KE20CA		P6KE24CA	4-1-33
P5KE22A		P6KE27A	4-1-33
P5KE22CA		P6KE27CA	4-1-33
P5KE24A		P6KE30A	4-1-33
P5KE24CA		P6KE30CA	4-1-33
P5KE26A		P6KE33A	4-1-33
P5KE26CA		P6KE33CA	4-1-33
P5KE28A		P6KE33A	4-1-33
P5KE28CA		P6KE33CA	4-1-33
P5KE30A		P6KE36A	4-1-33
P5KE30CA		P6KE36CA	4-1-33
P5KE33A		P6KE39A	4-1-33
P5KE33CA		P6KE39CA	4-1-33
P5KE36A		P6KE43A	4-1-33
P5KE36CA		P6KE43CA	4-1-33
P5KE40A		P6KE47A	4-1-33
P5KE40CA		P6KE47CA	4-1-33
P5KE43A		P6KE51A	4-1-33
P5KE43CA		P6KE51CA	4-1-33
P5KE45A		P6KE56A	4-1-33
P5KE45CA		P6KE56CA	4-1-33
P5KE48A		P6KE56A	4-1-33
P5KE48CA		P6KE56CA	4-1-33
P5KE5.0A		P6KE6.8A	4-1-33
P5KE5.0CA		P6KE6.8CA	4-1-33
P5KE51A		P6KE62A	4-1-33
P5KE51CA		P6KE62CA	4-1-33
P5KE54A		P6KE68A	4-1-34
P5KE54CA		P6KE68CA	4-1-34
P5KE58A		P6KE68A	4-1-34
P5KE58CA		P6KE68CA	4-1-34
P5KE6.0A		P6KE7.5A	4-1-33
P5KE6.0CA		P6KE7.5CA	4-1-33
P5KE6.5A		P6KE7.5A	4-1-33
P5KE6.5CA		P6KE7.5CA	4-1-33
P5KE60A		P6KE75A	4-1-34
P5KE60CA		P6KE75CA	4-1-34
P5KE64A		P6KE75A	4-1-34
P5KE64CA		P6KE75CA	4-1-34
P5KE7.0A		P6KE8.2A	4-1-33
P5KE7.0CA		P6KE8.2CA	4-1-33
P5KE7.5A		P6KE9.1A	4-1-33
P5KE7.5CA		P6KE9.1CA	4-1-33
P5KE70A		P6KE82A	4-1-34
P5KE70CA		P6KE82CA	4-1-34
P5KE75A		P6KE91A	4-1-34
P5KE75CA		P6KE91CA	4-1-34
P5KE78A		P6KE91A	4-1-34
P5KE78CA		P6KE91CA	4-1-34



CF = consult factory representative

CROSS-REFERENCE (continued)

Industry Part Number	Motorola Direct Replacement	Motorola Similar Replacement	Page Number
P5KE8.0A		P6KE10A	4-1-33
P5KE8.0CA		P6KE10CA	4-1-33
P5KE8.5A		P6KE10A	4-1-33
P5KE8.5CA		P6KE10CA	4-1-33
P5KE85A		P6KE100A	4-1-34
P5KE85CA		P6KE100CA	4-1-34
P5KE9.0A		P6KE11A	4-1-33
P5KE9.0CA		P6KE11CA	4-1-33
P5KE90A		P6KE110A	4-1-34
P5KE90CA		P6KE110CA	4-1-34
P6KE10	P6KE10		4-1-33
P6KE100	P6KE100		4-1-34
P6KE100A	P6KE100A		4-1-34
P6KE100C	P6KE100C		4-1-34
P6KE100CA	P6KE100CA		4-1-34
P6KE100CP		P6KE100CA	4-1-34
P6KE100P		P6KE100A	4-1-34
P6KE10A	P6KE10A		4-1-33
P6KE10C	P6KE10C		4-1-33
P6KE10CA	P6KE10CA		4-1-33
P6KE10CP		P6KE10CA	4-1-33
P6KE10P		P6KE10A	4-1-33
P6KE11	P6KE11		4-1-33
P6KE110	P6KE110		4-1-34
P6KE110A	P6KE110A		4-1-34
P6KE110C	P6KE110C		4-1-34
P6KE110CA	P6KE110CA		4-1-34
P6KE110CP		P6KE110CA	4-1-34
P6KE110P		P6KE110A	4-1-34
P6KE11A	P6KE11A		4-1-33
P6KE11C	P6KE11C		4-1-33
P6KE11CA	P6KE11CA		4-1-33
P6KE11CP		P6KE11CA	4-1-33
P6KE11P		P6KE11A	4-1-33
P6KE12	P6KE12		4-1-33
P6KE120	P6KE120		4-1-34
P6KE120A	P6KE120A		4-1-34
P6KE120C	P6KE120C		4-1-34
P6KE120CA	P6KE120CA		4-1-34
P6KE120CP		P6KE120CA	4-1-34
P6KE120P		P6KE120A	4-1-34
P6KE12A	P6KE12A		4-1-33
P6KE12C	P6KE12C		4-1-33
P6KE12CA	P6KE12CA		4-1-33
P6KE12CP		P6KE12CA	4-1-33
P6KE12P		P6KE12A	4-1-33
P6KE13	P6KE13		4-1-33
P6KE130	P6KE130		4-1-34
P6KE130A	P6KE130A		4-1-34
P6KE130C	P6KE130C		4-1-34
P6KE130CA	P6KE130CA		4-1-34

Industry Part Number	Motorola Direct Replacement	Motorola Similar Replacement	Page Number
P6KE130CP		P6KE130CA	4-1-34
P6KE130P		P6KE130A	4-1-34
P6KE13A	P6KE13A		4-1-33
P6KE13C	P6KE13C		4-1-33
P6KE13CA	P6KE13CA		4-1-33
P6KE13CP		P6KE13CA	4-1-33
P6KE13P		P6KE13A	4-1-33
P6KE15	P6KE15		4-1-33
P6KE150	P6KE150		4-1-34
P6KE150A	P6KE150A		4-1-34
P6KE150C	P6KE150C		4-1-34
P6KE150CA	P6KE150CA		4-1-34
P6KE150CP		P6KE150CA	4-1-34
P6KE150P		P6KE150A	4-1-34
P6KE15A	P6KE15A		4-1-33
P6KE15C	P6KE15C		4-1-33
P6KE15CA	P6KE15CA		4-1-33
P6KE15CP		P6KE15CA	4-1-33
P6KE15P		P6KE15A	4-1-33
P6KE16	P6KE16		4-1-33
P6KE160	P6KE160		4-1-34
P6KE160A	P6KE160A		4-1-34
P6KE160C	P6KE160C		4-1-34
P6KE160CA	P6KE160CA		4-1-34
P6KE160CP		P6KE160CA	4-1-34
P6KE160P		P6KE160A	4-1-34
P6KE16A	P6KE16A		4-1-33
P6KE16C	P6KE16C		4-1-33
P6KE16CA	P6KE16CA		4-1-33
P6KE16CP		P6KE16CA	4-1-33
P6KE16P		P6KE16A	4-1-33
P6KE170	P6KE170		4-1-34
P6KE170A	P6KE170A		4-1-34
P6KE170C	P6KE170C		4-1-34
P6KE170CA	P6KE170CA		4-1-34
P6KE170CP		P6KE170CA	4-1-34
P6KE170P		P6KE170A	4-1-34
P6KE18	P6KE18		4-1-33
P6KE180	P6KE180		4-1-34
P6KE180A	P6KE180A		4-1-34
P6KE180C	P6KE180C		4-1-34
P6KE180CA	P6KE180CA		4-1-34
P6KE180CP		P6KE180CA	4-1-34
P6KE180P		P6KE180A	4-1-34
P6KE18A	P6KE18A		4-1-33
P6KE18C	P6KE18C		4-1-33
P6KE18CA	P6KE18CA		4-1-33
P6KE18CP		P6KE18CA	4-1-33
P6KE18P		P6KE18A	4-1-33
P6KE20	P6KE20		4-1-33
P6KE200	P6KE200		4-1-34

CF = consult factory representative

CROSS-REFERENCE (continued)

Industry Part Number	Motorola Direct Replacement	Motorola Similar Replacement	Page Number
P6KE200A	P6KE200A		4-1-34
P6KE200C	P6KE200C		4-1-34
P6KE200CA	P6KE200CA		4-1-34
P6KE200CP		P6KE200CA	4-1-34
P6KE200P		P6KE200A	4-1-34
P6KE20A	P6KE20A		4-1-33
P6KE20C	P6KE20C		4-1-33
P6KE20CA	P6KE20CA		4-1-33
P6KE20CP		P6KE20CA	4-1-33
P6KE20P		P6KE20A	4-1-33
P6KE22	P6KE22		4-1-33
P6KE220CP		1.5KE220CA	4-1-44
P6KE220P		1.5KE220A	4-1-44
P6KE22A	P6KE22A		4-1-33
P6KE22C	P6KE22C		4-1-33
P6KE22CA	P6KE22CA		4-1-33
P6KE22CP		P6KE22CA	4-1-33
P6KE22P		P6KE22A	4-1-33
P6KE24	P6KE24		4-1-33
P6KE24A	P6KE24A		4-1-33
P6KE24C	P6KE24C		4-1-33
P6KE24CA	P6KE24CA		4-1-33
P6KE24CP		P6KE24CA	4-1-33
P6KE24P		P6KE24A	4-1-33
P6KE250CP		1.5KE250CA	4-1-44
P6KE250P		1.5KE250A	4-1-44
P6KE27	P6KE27		4-1-33
P6KE27A	P6KE27A		4-1-33
P6KE27C	P6KE27C		4-1-33
P6KE27CA	P6KE27CA		4-1-33
P6KE27CP		P6KE27CA	4-1-33
P6KE27P		P6KE27A	4-1-33
P6KE30	P6KE30		4-1-33
P6KE30A	P6KE30A		4-1-33
P6KE30C	P6KE30C		4-1-33
P6KE30CA	P6KE30CA		4-1-33
P6KE30CP		P6KE30CA	4-1-33
P6KE30P		P6KE30A	4-1-33
P6KE33	P6KE33		4-1-33
P6KE33A	P6KE33A		4-1-33
P6KE33C	P6KE33C		4-1-33
P6KE33CA	P6KE33CA		4-1-33
P6KE33CP		P6KE33CA	4-1-33
P6KE33P		P6KE33A	4-1-33
P6KE36	P6KE36		4-1-33
P6KE36A	P6KE36A		4-1-33
P6KE36C	P6KE36C		4-1-33
P6KE36CA	P6KE36CA		4-1-33
P6KE36CP		P6KE36CA	4-1-33
P6KE36P		P6KE36A	4-1-33
P6KE39	P6KE39		4-1-33

Industry Part Number	Motorola Direct Replacement	Motorola Similar Replacement	Page Number
P6KE39A	P6KE39A		4-1-33
P6KE39C	P6KE39C		4-1-33
P6KE39CA	P6KE39CA		4-1-33
P6KE39CP		P6KE39CA	4-1-33
P6KE39P		P6KE39A	4-1-33
P6KE43	P6KE43		4-1-33
P6KE43A	P6KE43A		4-1-33
P6KE43C	P6KE43C		4-1-33
P6KE43CA	P6KE43CA		4-1-33
P6KE43CP		P6KE43CA	4-1-33
P6KE43P		P6KE43A	4-1-33
P6KE47	P6KE47		4-1-33
P6KE47A	P6KE47A		4-1-33
P6KE47C	P6KE47C		4-1-33
P6KE47CA	P6KE47CA		4-1-33
P6KE47CP		P6KE47CA	4-1-33
P6KE47P		P6KE47A	4-1-33
P6KE51	P6KE51		4-1-33
P6KE51A	P6KE51A		4-1-33
P6KE51C	P6KE51C		4-1-33
P6KE51CA	P6KE51CA		4-1-33
P6KE51CP		P6KE51CA	4-1-33
P6KE51P		P6KE51A	4-1-33
P6KE56	P6KE56		4-1-33
P6KE56A	P6KE56A		4-1-33
P6KE56C	P6KE56C		4-1-33
P6KE56CA	P6KE56CA		4-1-33
P6KE56CP		P6KE56CA	4-1-33
P6KE56P		P6KE56A	4-1-33
P6KE6.8	P6KE6.8		4-1-33
P6KE6.8A	P6KE6.8A		4-1-33
P6KE6.8C	P6KE6.8C		4-1-33
P6KE6.8CA	P6KE6.8CA		4-1-33
P6KE62	P6KE62		4-1-33
P6KE62A	P6KE62A		4-1-33
P6KE62C	P6KE62C		4-1-33
P6KE62CA	P6KE62CA		4-1-33
P6KE62CP		P6KE62CA	4-1-33
P6KE62P		P6KE62A	4-1-33
P6KE68	P6KE68		4-1-34
P6KE68A	P6KE68A		4-1-34
P6KE68C	P6KE68C		4-1-34
P6KE68CA	P6KE68CA		4-1-34
P6KE68CP		P6KE68CA	4-1-34
P6KE68P		P6KE68A	4-1-34
P6KE6V8A		P6KE6.8A	4-1-33
P6KE6V8CA		P6KE6.8CA	4-1-33
P6KE6V8CP		P6KE6.8CA	4-1-33
P6KE6V8P		P6KE6.8A	4-1-33
P6KE7.5	P6KE7.5		4-1-33
P6KE7.5A	P6KE7.5A		4-1-33



CF = consult factory representative

CROSS-REFERENCE (continued)

Industry Part Number	Motorola Direct Replacement	Motorola Similar Replacement	Page Number
P6KE7.5C	P6KE7.5C		4-1-33
P6KE7.5CA	P6KE7.5CA		4-1-33
P6KE75	P6KE75		4-1-34
P6KE75A	P6KE75A		4-1-34
P6KE75C	P6KE75C		4-1-34
P6KE75CA	P6KE75CA		4-1-34
P6KE75CP		P6KE75CA	4-1-34
P6KE75P		P6KE75A	4-1-34
P6KE7V5A		P6KE7.5A	4-1-33
P6KE7V5CA		P6KE7.5CA	4-1-33
P6KE7V5CP		P6KE7.5CA	4-1-33
P6KE7V5P		P6KE7.5A	4-1-33
P6KE8.2	P6KE8.2		4-1-33
P6KE8.2A	P6KE8.2A		4-1-33
P6KE8.2C	P6KE8.2C		4-1-33
P6KE8.2CA	P6KE8.2CA		4-1-33
P6KE82	P6KE82		4-1-34
P6KE82A	P6KE82A		4-1-34
P6KE82C	P6KE82C		4-1-34
P6KE82CA	P6KE82CA		4-1-34
P6KE82CP		P6KE82CA	4-1-34
P6KE82P		P6KE82A	4-1-34
P6KE8V2A		P6KE8.2A	4-1-33
P6KE8V2CA		P6KE8.2CA	4-1-33
P6KE8V2CP		P6KE8.2CA	4-1-33
P6KE8V2P		P6KE8.2A	4-1-33
P6KE9.1	P6KE9.1		4-1-33
P6KE9.1A	P6KE9.1A		4-1-33
P6KE9.1C	P6KE9.1C		4-1-33
P6KE9.1CA	P6KE9.1CA		4-1-33
P6KE91	P6KE91		4-1-34
P6KE91A	P6KE91A		4-1-34
P6KE91C	P6KE91C		4-1-34
P6KE91CA	P6KE91CA		4-1-34
P6KE91CP		P6KE91CA	4-1-34
P6KE91P		P6KE91A	4-1-34
P6KE9V1A		P6KE9.1A	4-1-33
P6KE9V1CA		P6KE9.1CA	4-1-33
P6KE9V1CP		P6KE9.1CA	4-1-33
P6KE9V1P		P6KE9.1A	4-1-33
P6SMB100AT3	P6SMB100AT3		4-1-60
P6SMB10AT3	P6SMB10AT3		4-1-60
P6SMB110AT3	P6SMB110AT3		4-1-60
P6SMB11AT3	P6SMB11AT3		4-1-60
P6SMB120AT3	P6SMB120AT3		4-1-60
P6SMB12AT3	P6SMB12AT3		4-1-60
P6SMB130AT3	P6SMB130AT3		4-1-60
P6SMB13AT3	P6SMB13AT3		4-1-60
P6SMB150AT3	P6SMB150AT3		4-1-60
P6SMB15AT3	P6SMB15AT3		4-1-60
P6SMB160AT3	P6SMB160AT3		4-1-60

Industry Part Number	Motorola Direct Replacement	Motorola Similar Replacement	Page Number
P6SMB16AT3	P6SMB16AT3		4-1-60
P6SMB170AT3	P6SMB170AT3		4-1-60
P6SMB180AT3	P6SMB180AT3		4-1-60
P6SMB18AT3	P6SMB18AT3		4-1-60
P6SMB200AT3	P6SMB200AT3		4-1-60
P6SMB20AT3	P6SMB20AT3		4-1-60
P6SMB22AT3	P6SMB22AT3		4-1-60
P6SMB24AT3	P6SMB24AT3		4-1-60
P6SMB27AT3	P6SMB27AT3		4-1-60
P6SMB30AT3	P6SMB30AT3		4-1-60
P6SMB33AT3	P6SMB33AT3		4-1-60
P6SMB36AT3	P6SMB36AT3		4-1-60
P6SMB39AT3	P6SMB39AT3		4-1-60
P6SMB43AT3	P6SMB43AT3		4-1-60
P6SMB47AT3	P6SMB47AT3		4-1-60
P6SMB51AT3	P6SMB51AT3		4-1-60
P6SMB56AT3	P6SMB56AT3		4-1-60
P6SMB6.8AT3	P6SMB6.8AT3		4-1-60
P6SMB62AT3	P6SMB62AT3		4-1-60
P6SMB68AT3	P6SMB68AT3		4-1-60
P6SMB7.5AT3	P6SMB7.5AT3		4-1-60
P6SMB75AT3	P6SMB75AT3		4-1-60
P6SMB8.2AT3	P6SMB8.2AT3		4-1-60
P6SMB82AT3	P6SMB82AT3		4-1-60
P6SMB9.1AT3	P6SMB9.1AT3		4-1-60
P6SMB91AT3	P6SMB91AT3		4-1-60
P7KE10		1N6275	4-1-43
P7KE100		1N6299	4-1-44
P7KE100C		1.5KE150C	4-1-44
P7KE10C		1.5KE15C	4-1-43
P7KE25		1N6284	4-1-43
P7KE25C		1.5KE36C	4-1-43
P7KE43		1N6289	4-1-44
P7KE43C		1.5KE56C	4-1-44
P7T-10		1N6276	4-1-43
P7T-10B		1.5KE16C	4-1-43
P7T-110		1N6299	4-1-44
P7T-110B		1.5KE150C	4-1-44
P7T-27		1N6283	4-1-43
P7T-27B		1.5KE33C	4-1-43
P7T-43		1N6290	4-1-44
P7T-43B		1.5KE62C	4-1-44
PF8Z10		1N6271	4-1-43
PF8Z100		1N6295	4-1-44
PF8Z12		1N6273	4-1-43
PF8Z120		1N6297	4-1-44
PF8Z15		1N6275	4-1-43
PF8Z150		1N6299	4-1-44
PF8Z18		1N6277	4-1-43
PF8Z180		1N6302	4-1-44
PF8Z22		1N6279	4-1-43

CF = consult factory representative

CROSS-REFERENCE (continued)

Industry Part Number	Motorola Direct Replacement	Motorola Similar Replacement	Page Number
PF8Z27		1N6281	4-1-43
PF8Z33		1N6283	4-1-43
PF8Z39		1N6285	4-1-43
PF8Z47		1N6287	4-1-43
PF8Z56		1N6289	4-1-44
PF8Z62		1N6290	4-1-44
PF8Z68		1N6291	4-1-44
PF8Z6V8		1N6267	4-1-43
PF8Z82		1N6293	4-1-44
PF8Z8V2		1N6269	4-1-43
PFZ10		1N6271	4-1-43
PFZ100		1N6295	4-1-44
PFZ100A		1N6295A	4-1-44
PFZ10A		1N6271A	4-1-43
PFZ11		1N6272	4-1-43
PFZ110		1N6296	4-1-44
PFZ110A		1N6296A	4-1-44
PFZ11A		1N6272A	4-1-43
PFZ12		1N6273	4-1-43
PFZ120		1N6297	4-1-44
PFZ120A		1N6297A	4-1-44
PFZ12A		1N6273A	4-1-43
PFZ13		1N6274	4-1-43
PFZ130		1N6298	4-1-44
PFZ130A		1N6298A	4-1-44
PFZ13A		1N6274A	4-1-43
PFZ15		1N6275	4-1-43
PFZ150		1N6299	4-1-44
PFZ150A		1N6299A	4-1-44
PFZ15A		1N6275A	4-1-43
PFZ16		1N6276	4-1-43
PFZ160		1N6300	4-1-44
PFZ160A		1N6300A	4-1-44
PFZ16A		1N6276A	4-1-43
PFZ170		1N6301	4-1-44
PFZ170A		1N6301A	4-1-44
PFZ18		1N6277	4-1-43
PFZ180		1N6302	4-1-44
PFZ180A		1N6302A	4-1-44
PFZ18A		1N6277A	4-1-43
PFZ20		1N6278	4-1-43
PFZ200		1N6303	4-1-44
PFZ200A		1N6303A	4-1-44
PFZ20A		1N6278A	4-1-43
PFZ22		1N6279	4-1-43
PFZ220		1.5KE220	4-1-44
PFZ220A		1.5KE220A	4-1-44
PFZ22A		1N6279A	4-1-43
PFZ24		1N6280	4-1-43
PFZ24A		1N6280A	4-1-43
PFZ250		1.5KE250	4-1-44

Industry Part Number	Motorola Direct Replacement	Motorola Similar Replacement	Page Number
PFZ250A		1.5KE250A	4-1-44
PFZ27		1N6281	4-1-43
PFZ27A		1N6281A	4-1-43
PFZ30		1N6282	4-1-43
PFZ30A		1N6282A	4-1-43
PFZ33		1N6283	4-1-43
PFZ33A		1N6283A	4-1-43
PFZ36		1N6284	4-1-43
PFZ36A		1N6284A	4-1-43
PFZ39		1N6285	4-1-43
PFZ39A		1N6285A	4-1-43
PFZ43		1N6286	4-1-43
PFZ43A		1N6286A	4-1-43
PFZ47		1N6287	4-1-43
PFZ47A		1N6287A	4-1-43
PFZ51		1N6288	4-1-43
PFZ51A		1N6288A	4-1-43
PFZ56		1N6289	4-1-44
PFZ56A		1N6289A	4-1-44
PFZ62		1N6290	4-1-44
PFZ62A		1N6290A	4-1-44
PFZ68		1N6291	4-1-44
PFZ68A		1N6291A	4-1-44
PFZ6V8		1N6267	4-1-43
PFZ6V8A		1N6267A	4-1-43
PFZ75		1N6292	4-1-44
PFZ75A		1N6292A	4-1-44
PFZ7V5		1N6268	4-1-43
PFZ7V5A		1N6268A	4-1-43
PFZ82		1N6293	4-1-44
PFZ82A		1N6293A	4-1-44
PFZ8V2		1N6269	4-1-43
PFZ8V2A		1N6269A	4-1-43
PFZ91		1N6294	4-1-44
PFZ91A		1N6294A	4-1-44
PFZ9V1		1N6270	4-1-43
PFZ9V1A		1N6270A	4-1-43
PFZD10		1.5KE10C	4-1-43
PFZD100		1.5KE100C	4-1-44
PFZD12		1.5KE12C	4-1-43
PFZD120		1.5KE120C	4-1-44
PFZD15		1.5KE15C	4-1-43
PFZD150		1.5KE150C	4-1-44
PFZD18		1.5KE18C	4-1-43
PFZD180		1.5KE180C	4-1-44
PFZD22		1.5KE22C	4-1-43
PFZD27		1.5KE27C	4-1-43
PFZD33		1.5KE33C	4-1-43
PFZD39		1.5KE39C	4-1-43
PFZD47		1.5KE47C	4-1-43
PFZD56		1.5KE56C	4-1-44

2

CF = consult factory representative

CROSS-REFERENCE (continued)

2

Industry Part Number	Motorola Direct Replacement	Motorola Similar Replacement	Page Number
PFZD62		1.5KE62C	4-1-44
PFZD68		1.5KE68C	4-1-44
PFZD6V8		1.5KE6.8C	4-1-43
PFZD82		1.5KE82C	4-1-44
PFZD8V2		1.5KE8.2C	4-1-43
PZD16		1.5KE16C	4-1-43
PZD160		1.5KE160C	4-1-44
PZD36		1.5KE36C	4-1-43
PZD62		1.5KE62C	4-1-44
SA10	SA10		4-1-26
SA100	SA100		4-1-27
SA100A	SA100A		4-1-27
SA100C	SA100C		4-1-27
SA100CA	SA100CA		4-1-27
SA10A	SA10A		4-1-26
SA10C	SA10C		4-1-26
SA10CA	SA10CA		4-1-26
SA11	SA11		4-1-26
SA110	SA110		4-1-27
SA110A	SA110A		4-1-27
SA110C	SA110C		4-1-27
SA110CA	SA110CA		4-1-27
SA11A	SA11A		4-1-26
SA11C	SA11C		4-1-26
SA11CA	SA11CA		4-1-26
SA12	SA12		4-1-26
SA120	SA120		4-1-27
SA120A	SA120A		4-1-27
SA120C	SA120C		4-1-27
SA120CA	SA120CA		4-1-27
SA12A	SA12A		4-1-26
SA12C	SA12C		4-1-26
SA12CA	SA12CA		4-1-26
SA13	SA13		4-1-26
SA130	SA130		4-1-27
SA130A	SA130A		4-1-27
SA130C	SA130C		4-1-27
SA130CA	SA130CA		4-1-27
SA13A	SA13A		4-1-26
SA13C	SA13C		4-1-26
SA13CA	SA13CA		4-1-26
SA14	SA14		4-1-26
SA14A	SA14A		4-1-26
SA14C	SA14C		4-1-26
SA14CA	SA14CA		4-1-26
SA15	SA15		4-1-26
SA150	SA150		4-1-27
SA150A	SA150A		4-1-27
SA150C	SA150C		4-1-27
SA150CA	SA150CA		4-1-27
SA15A	SA15A		4-1-26

Industry Part Number	Motorola Direct Replacement	Motorola Similar Replacement	Page Number
SA15C	SA15C		4-1-26
SA15CA	SA15CA		4-1-26
SA16	SA16		4-1-26
SA160	SA160		4-1-27
SA160A	SA160A		4-1-27
SA160C	SA160C		4-1-27
SA160CA	SA160CA		4-1-27
SA16A	SA16A		4-1-26
SA16C	SA16C		4-1-26
SA16CA	SA16CA		4-1-26
SA17	SA17		4-1-26
SA170	SA170		4-1-27
SA170A	SA170A		4-1-27
SA170C	SA170C		4-1-27
SA170CA	SA170CA		4-1-27
SA17A	SA17A		4-1-26
SA17C	SA17C		4-1-26
SA17CA	SA17CA		4-1-26
SA18	SA18		4-1-26
SA18A	SA18A		4-1-26
SA18C	SA18C		4-1-26
SA18CA	SA18CA		4-1-26
SA20	SA20		4-1-26
SA20A	SA20A		4-1-26
SA20C	SA20C		4-1-26
SA20CA	SA20CA		4-1-26
SA22	SA22		4-1-26
SA22A	SA22A		4-1-26
SA22C	SA22C		4-1-26
SA22CA	SA22CA		4-1-26
SA24	SA24		4-1-26
SA24A	SA24A		4-1-26
SA24C	SA24C		4-1-26
SA24CA	SA24CA		4-1-26
SA26	SA26		4-1-26
SA26A	SA26A		4-1-26
SA26C	SA26C		4-1-26
SA26CA	SA26CA		4-1-26
SA28	SA28		4-1-26
SA28A	SA28A		4-1-26
SA28C	SA28C		4-1-26
SA28CA	SA28CA		4-1-26
SA30	SA30		4-1-26
SA30A	SA30A		4-1-26
SA30C	SA30C		4-1-26
SA30CA	SA30CA		4-1-26
SA33	SA33		4-1-26
SA33A	SA33A		4-1-26
SA33C	SA33C		4-1-26
SA33CA	SA33CA		4-1-26
SA36	SA36		4-1-27

CF = consult factory representative

CROSS-REFERENCE (continued)

Industry Part Number	Motorola Direct Replacement	Motorola Similar Replacement	Page Number
SA36A	SA36A		4-1-27
SA36C	SA36C		4-1-27
SA36CA	SA36CA		4-1-27
SA40	SA40		4-1-27
SA40A	SA40A		4-1-27
SA40C	SA40C		4-1-27
SA40CA	SA40CA		4-1-27
SA43	SA43		4-1-27
SA43A	SA43A		4-1-27
SA43C	SA43C		4-1-27
SA43CA	SA43CA		4-1-27
SA45	SA45		4-1-27
SA45A	SA45A		4-1-27
SA45C	SA45C		4-1-27
SA45CA	SA45CA		4-1-27
SA48	SA48		4-1-27
SA48A	SA48A		4-1-27
SA48C	SA48C		4-1-27
SA48CA	SA48CA		4-1-27
SA5.0	SA5.0		4-1-26
SA5.0A	SA5.0A		4-1-26
SA5.0C			CF
SA5.0CA			CF
SA51	SA51		4-1-27
SA51A	SA51A		4-1-27
SA51C	SA51C		4-1-27
SA51CA	SA51CA		4-1-27
SA54	SA54		4-1-27
SA54A	SA54A		4-1-27
SA54C	SA54C		4-1-27
SA54CA	SA54CA		4-1-27
SA58	SA58		4-1-27
SA58A	SA58A		4-1-27
SA58C	SA58C		4-1-27
SA58CA	SA58CA		4-1-27
SA6.0	SA6.0		4-1-26
SA6.0A	SA6.0A		4-1-26
SA6.0C	SA6.0C		4-1-26
SA6.0CA	SA6.0CA		4-1-26
SA6.5	SA6.5		4-1-26
SA6.5A	SA6.5A		4-1-26
SA6.5C	SA6.5C		4-1-26
SA6.5CA	SA6.5CA		4-1-26
SA60	SA60		4-1-27
SA60A	SA60A		4-1-27
SA60C	SA60C		4-1-27
SA60CA	SA60CA		4-1-27
SA64	SA64		4-1-27
SA64A	SA64A		4-1-27
SA64C	SA64C		4-1-27
SA64CA	SA64CA		4-1-27

Industry Part Number	Motorola Direct Replacement	Motorola Similar Replacement	Page Number
SA7.0	SA7.0		4-1-26
SA7.0A	SA7.0A		4-1-26
SA7.0C	SA7.0C		4-1-26
SA7.0CA	SA7.0CA		4-1-26
SA7.5	SA7.5		4-1-26
SA7.5A	SA7.5A		4-1-26
SA7.5C	SA7.5C		4-1-26
SA7.5CA	SA7.5CA		4-1-26
SA70	SA70		4-1-27
SA70A	SA70A		4-1-27
SA70C	SA70C		4-1-27
SA70CA	SA70CA		4-1-27
SA75	SA75		4-1-27
SA75A	SA75A		4-1-27
SA75C	SA75C		4-1-27
SA75CA	SA75CA		4-1-27
SA78	SA78		4-1-27
SA78A	SA78A		4-1-27
SA78C	SA78C		4-1-27
SA78CA	SA78CA		4-1-27
SA8.0	SA8.0		4-1-26
SA8.0A	SA8.0A		4-1-26
SA8.0C	SA8.0C		4-1-26
SA8.0CA	SA8.0CA		4-1-26
SA8.5	SA8.5		4-1-26
SA8.5A	SA8.5A		4-1-26
SA8.5C	SA8.5C		4-1-26
SA8.5CA	SA8.5CA		4-1-26
SA85	SA85		4-1-27
SA85A	SA85A		4-1-27
SA85C	SA85C		4-1-27
SA85CA	SA85CA		4-1-27
SA9.0	SA9.0		4-1-26
SA9.0A	SA9.0A		4-1-26
SA9.0C	SA9.0C		4-1-26
SA9.0CA	SA9.0CA		4-1-26
SA90	SA90		4-1-27
SA90A	SA90A		4-1-27
SA90C	SA90C		4-1-27
SA90CA	SA90CA		4-1-27
SAB10		SA10A	4-1-26
SAB12		SA12A	4-1-26
SAB15		SA15A	4-1-26
SAB18		SA18A	4-1-26
SAB24		SA24A	4-1-26
SAB28		SA28A	4-1-26
SAB5.0		SA5.0A	4-1-26
SBL10		1N6276	4-1-43
SBL100		1N6299	4-1-44
SBL100C		1.5KE150C	4-1-44
SBL10C		1.5KE16C	4-1-43



CF = consult factory representative

CROSS-REFERENCE (continued)

2

Industry Part Number	Motorola Direct Replacement	Motorola Similar Replacement	Page Number
SBL25		1N6284	4-1-43
SBL25C		1.5KE36C	4-1-43
SBL43		1N6290	4-1-44
SBL43C		1.5KE62C	4-1-44
SM15T10		1.5SMC10AT3	4-1-66
SM15T10A		1.5SMC10AT3	4-1-66
SM15T12		1.5SMC12AT3	4-1-66
SM15T12A		1.5SMC12AT3	4-1-66
SM15T15		1.5SMC15AT3	4-1-66
SM15T15A		1.5SMC15AT3	4-1-66
SM15T18		1.5SMC18AT3	4-1-66
SM15T18A		1.5SMC18AT3	4-1-66
SM15T22		1.5SMC22AT3	4-1-66
SM15T22A		1.5SMC22AT3	4-1-66
SM15T24		1.5SMC24AT3	4-1-66
SM15T24A		1.5SMC24AT3	4-1-66
SM15T27		1.5SMC27AT3	4-1-66
SM15T27A		1.5SMC27AT3	4-1-66
SM15T30		1.5SMC30AT3	4-1-66
SM15T30A		1.5SMC30AT3	4-1-66
SM15T33		1.5SMC33AT3	4-1-66
SM15T33A		1.5SMC33AT3	4-1-66
SM15T36		1.5SMC36AT3	4-1-66
SM15T36A		1.5SMC36AT3	4-1-66
SM15T39		1.5SMC39AT3	4-1-66
SM15T39A		1.5SMC39AT3	4-1-66
SM15T68		1.5SMC68AT3	4-1-66
SM15T68A		1.5SMC68AT3	4-1-66
SM15T6V8		1.5SMC6.8AT3	4-1-66
SM15T6V8A		1.5SMC6.8AT3	4-1-66
SM15T7V5		1.5SMC7.5AT3	4-1-66
SM15T7V5A		1.5SMC7.5AT3	4-1-66
SM4T10		P6SMB10AT3	4-1-60
SM4T100		P6SMB100AT3	4-1-60
SM4T100A		P6SMB100AT3	4-1-60
SM4T10A		P6SMB10AT3	4-1-60
SM4T12		P6SMB12AT3	4-1-60
SM4T12A		P6SMB12AT3	4-1-60
SM4T15		P6SMB15AT3	4-1-60
SM4T150		P6SMB150AT3	4-1-60
SM4T150A		P6SMB150AT3	4-1-60
SM4T15A		P6SMB15AT3	4-1-60
SM4T18		P6SMB18AT3	4-1-60
SM4T18A		P6SMB18AT3	4-1-60
SM4T200		P6SMB200AT3	4-1-60
SM4T200A		P6SMB200AT3	4-1-60
SM4T22		P6SMB22AT3	4-1-60
SM4T22A		P6SMB22AT3	4-1-60
SM4T24		P6SMB24AT3	4-1-60
SM4T24A		P6SMB24AT3	4-1-60
SM4T27		P6SMB27AT3	4-1-60

Industry Part Number	Motorola Direct Replacement	Motorola Similar Replacement	Page Number
SM4T27A		P6SMB27AT3	4-1-60
SM4T30		P6SMB30AT3	4-1-60
SM4T30A		P6SMB30AT3	4-1-60
SM4T33		P6SMB33AT3	4-1-60
SM4T33A		P6SMB33AT3	4-1-60
SM4T36		P6SMB36AT3	4-1-60
SM4T36A		P6SMB36AT3	4-1-60
SM4T39		P6SMB39AT3	4-1-60
SM4T39A		P6SMB39AT3	4-1-60
SM4T68		P6SMB68AT3	4-1-60
SM4T68A		P6SMB68AT3	4-1-60
SM4T6V8		P6SMB6.8AT3	4-1-60
SM4T6V8A		P6SMB6.8AT3	4-1-60
SM4T7V5		P6SMB7.5AT3	4-1-60
SM4T7V5A		P6SMB7.5AT3	4-1-60
SM6T10		P6SMB10AT3	4-1-60
SM6T100		P6SMB100AT3	4-1-60
SM6T100A		P6SMB100AT3	4-1-60
SM6T10A		P6SMB10AT3	4-1-60
SM6T12		P6SMB12AT3	4-1-60
SM6T12A		P6SMB12AT3	4-1-60
SM6T15		P6SMB15AT3	4-1-60
SM6T150		P6SMB150AT3	4-1-60
SM6T150A		P6SMB150AT3	4-1-60
SM6T15A		P6SMB15AT3	4-1-60
SM6T18		P6SMB18AT3	4-1-60
SM6T18A		P6SMB18AT3	4-1-60
SM6T200		P6SMB200AT3	4-1-60
SM6T200A		P6SMB200AT3	4-1-60
SM6T22		P6SMB22AT3	4-1-60
SM6T22A		P6SMB22AT3	4-1-60
SM6T24		P6SMB24AT3	4-1-60
SM6T24A		P6SMB24AT3	4-1-60
SM6T27		P6SMB27AT3	4-1-60
SM6T27A		P6SMB27AT3	4-1-60
SM6T30		P6SMB30AT3	4-1-60
SM6T30A		P6SMB30AT3	4-1-60
SM6T33		P6SMB33AT3	4-1-60
SM6T33A		P6SMB33AT3	4-1-60
SM6T36		P6SMB36AT3	4-1-60
SM6T36A		P6SMB36AT3	4-1-60
SM6T39		P6SMB39AT3	4-1-60
SM6T39A		P6SMB39AT3	4-1-60
SM6T68		P6SMB68AT3	4-1-60
SM6T68A		P6SMB68AT3	4-1-60
SM6T6V8		P6SMB6.8AT3	4-1-60
SM6T6V8A		P6SMB6.8AT3	4-1-60
SM6T7V5		P6SMB7.5AT3	4-1-60
SM6T7V5A		P6SMB7.5AT3	4-1-60
SMBJ10	1SMB10AT3		4-1-59
SMBJ100	1SMB100AT3		4-1-59

CF = consult factory representative

CROSS-REFERENCE (continued)

Industry Part Number	Motorola Direct Replacement	Motorola Similar Replacement	Page Number
SMBJ100A	1SMB100AT3		4-1-59
SMBJ10A	1SMB10AT3		4-1-59
SMBJ11	1SMB11AT3		4-1-59
SMBJ110	1SMB110AT3		4-1-59
SMBJ110A	1SMB110AT3		4-1-59
SMBJ11A	1SMB11AT3		4-1-59
SMBJ12	1SMB12AT3		4-1-59
SMBJ120	1SMB120AT3		4-1-59
SMBJ120A	1SMB120AT3		4-1-59
SMBJ12A	1SMB12AT3		4-1-59
SMBJ13	1SMB13AT3		4-1-59
SMBJ130	1SMB130AT3		4-1-59
SMBJ130A	1SMB130AT3		4-1-59
SMBJ13A	1SMB13AT3		4-1-59
SMBJ14	1SMB14AT3		4-1-59
SMBJ14A	1SMB14AT3		4-1-59
SMBJ15	1SMB15AT3		4-1-59
SMBJ150	1SMB150AT3		4-1-59
SMBJ150A	1SMB150AT3		4-1-59
SMBJ15A	1SMB15AT3		4-1-59
SMBJ16	1SMB16AT3		4-1-59
SMBJ160	1SMB160AT3		4-1-59
SMBJ160A	1SMB160AT3		4-1-59
SMBJ16A	1SMB16AT3		4-1-59
SMBJ17	1SMB17AT3		4-1-59
SMBJ170	1SMB170AT3		4-1-59
SMBJ170A	1SMB170AT3		4-1-59
SMBJ17A	1SMB17AT3		4-1-59
SMBJ18	1SMB18AT3		4-1-59
SMBJ18A	1SMB18AT3		4-1-59
SMBJ20	1SMB20AT3		4-1-59
SMBJ20A	1SMB20AT3		4-1-59
SMBJ22	1SMB22AT3		4-1-59
SMBJ22A	1SMB22AT3		4-1-59
SMBJ24	1SMB24AT3		4-1-59
SMBJ24A	1SMB24AT3		4-1-59
SMBJ26	1SMB26AT3		4-1-59
SMBJ26A	1SMB26AT3		4-1-59
SMBJ28	1SMB28AT3		4-1-59
SMBJ28A	1SMB28AT3		4-1-59
SMBJ30	1SMB30AT3		4-1-59
SMBJ30A	1SMB30AT3		4-1-59
SMBJ33	1SMB33AT3		4-1-59
SMBJ33A	1SMB33AT3		4-1-59
SMBJ36	1SMB36AT3		4-1-59
SMBJ36A	1SMB36AT3		4-1-59
SMBJ40	1SMB40AT3		4-1-59
SMBJ40A	1SMB40AT3		4-1-59
SMBJ43	1SMB43AT3		4-1-59
SMBJ43A	1SMB43AT3		4-1-59
SMBJ45	1SMB45AT3		4-1-59

Industry Part Number	Motorola Direct Replacement	Motorola Similar Replacement	Page Number
SMBJ45A	1SMB45AT3		4-1-59
SMBJ48	1SMB48AT3		4-1-59
SMBJ48A	1SMB48AT3		4-1-59
SMBJ5.0	1SMB5.0AT3		4-1-59
SMBJ5.0A	1SMB5.0AT3		4-1-59
SMBJ51	1SMB51AT3		4-1-59
SMBJ51A	1SMB51AT3		4-1-59
SMBJ54	1SMB54AT3		4-1-59
SMBJ54A	1SMB54AT3		4-1-59
SMBJ58	1SMB58AT3		4-1-59
SMBJ58A	1SMB58AT3		4-1-59
SMBJ6.0	1SMB6.0AT3		4-1-59
SMBJ6.0A	1SMB6.0AT3		4-1-59
SMBJ6.5	1SMB6.5AT3		4-1-59
SMBJ6.5A	1SMB6.5AT3		4-1-59
SMBJ60	1SMB60AT3		4-1-59
SMBJ60A	1SMB60AT3		4-1-59
SMBJ64	1SMB64AT3		4-1-59
SMBJ64A	1SMB64AT3		4-1-59
SMBJ7.0	1SMB7.0AT3		4-1-59
SMBJ7.0A	1SMB7.0AT3		4-1-59
SMBJ7.5	1SMB7.5AT3		4-1-59
SMBJ7.5A	1SMB7.5AT3		4-1-59
SMBJ70	1SMB70AT3		4-1-59
SMBJ70A	1SMB70AT3		4-1-59
SMBJ75	1SMB75AT3		4-1-59
SMBJ75A	1SMB75AT3		4-1-59
SMBJ78	1SMB78AT3		4-1-59
SMBJ78A	1SMB78AT3		4-1-59
SMBJ8.0	1SMB8.0AT3		4-1-59
SMBJ8.0A	1SMB8.0AT3		4-1-59
SMBJ8.5	1SMB8.5AT3		4-1-59
SMBJ8.5A	1SMB8.5AT3		4-1-59
SMBJ85	1SMB85AT3		4-1-59
SMBJ85A	1SMB85AT3		4-1-59
SMBJ9.0	1SMB9.0AT3		4-1-59
SMBJ9.0A	1SMB9.0AT3		4-1-59
SMBJ90	1SMB90AT3		4-1-59
SMBJ90A	1SMB90AT3		4-1-59
SMCJ10	1SMC10AT3		4-1-65
SMCJ10A	1SMC10AT3		4-1-65
SMCJ11	1SMC11AT3		4-1-65
SMCJ11A	1SMC11AT3		4-1-65
SMCJ12	1SMC12AT3		4-1-65
SMCJ12A	1SMC12AT3		4-1-65
SMCJ13	1SMC13AT3		4-1-65
SMCJ13A	1SMC13AT3		4-1-65
SMCJ14	1SMC14AT3		4-1-65
SMCJ14A	1SMC14AT3		4-1-65
SMCJ15	1SMC15AT3		4-1-65
SMCJ15A	1SMC15AT3		4-1-65



CF = consult factory representative

CROSS-REFERENCE (continued)

Industry Part Number	Motorola Direct Replacement	Motorola Similar Replacement	Page Number
SMCJ16	1SMC16AT3		4-1-65
SMCJ16A	1SMC16AT3		4-1-65
SMCJ17	1SMC17AT3		4-1-65
SMCJ17A	1SMC17AT3		4-1-65
SMCJ18	1SMC18AT3		4-1-65
SMCJ18A	1SMC18AT3		4-1-65
SMCJ20	1SMC20AT3		4-1-65
SMCJ20A	1SMC20AT3		4-1-65
SMCJ22	1SMC22AT3		4-1-65
SMCJ22A	1SMC22AT3		4-1-65
SMCJ24	1SMC24AT3		4-1-65
SMCJ24A	1SMC24AT3		4-1-65
SMCJ26	1SMC26AT3		4-1-65
SMCJ26A	1SMC26AT3		4-1-65
SMCJ28	1SMC28AT3		4-1-65
SMCJ28A	1SMC28AT3		4-1-65
SMCJ30	1SMC30AT3		4-1-65
SMCJ30A	1SMC30AT3		4-1-65
SMCJ33	1SMC33AT3		4-1-65
SMCJ33A	1SMC33AT3		4-1-65
SMCJ36	1SMC36AT3		4-1-65
SMCJ36A	1SMC36AT3		4-1-65
SMCJ40	1SMC40AT3		4-1-65
SMCJ40A	1SMC40AT3		4-1-65
SMCJ43	1SMC43AT3		4-1-65
SMCJ43A	1SMC43AT3		4-1-65
SMCJ45	1SMC45AT3		4-1-65
SMCJ45A	1SMC45AT3		4-1-65
SMCJ48	1SMC48AT3		4-1-65
SMCJ48A	1SMC48AT3		4-1-65
SMCJ5.0	1SMC5.0AT3		4-1-65
SMCJ5.0A	1SMC5.0AT3		4-1-65
SMCJ51	1SMC51AT3		4-1-65
SMCJ51A	1SMC51AT3		4-1-65
SMCJ54	1SMC54AT3		4-1-65
SMCJ54A	1SMC54AT3		4-1-65
SMCJ58	1SMC58AT3		4-1-65
SMCJ58A	1SMC58AT3		4-1-65
SMCJ6.0	1SMC6.0AT3		4-1-65
SMCJ6.0A	1SMC6.0AT3		4-1-65
SMCJ6.5	1SMC6.5AT3		4-1-65
SMCJ6.5A	1SMC6.5AT3		4-1-65
SMCJ60	1SMC60AT3		4-1-65
SMCJ60A	1SMC60AT3		4-1-65
SMCJ64	1SMC64AT3		4-1-65
SMCJ64A	1SMC64AT3		4-1-65
SMCJ7.0	1SMC7.0AT3		4-1-65
SMCJ7.0A	1SMC7.0AT3		4-1-65
SMCJ7.5	1SMC7.5AT3		4-1-65
SMCJ7.5A	1SMC7.5AT3		4-1-65
SMCJ70	1SMC70AT3		4-1-65

Industry Part Number	Motorola Direct Replacement	Motorola Similar Replacement	Page Number
SMCJ70A	1SMC70AT3		4-1-65
SMCJ75	1SMC75AT3		4-1-65
SMCJ75A	1SMC75AT3		4-1-65
SMCJ78	1SMC78AT3		4-1-65
SMCJ78A	1SMC78AT3		4-1-65
SMCJ8.0	1SMC8.0AT3		4-1-65
SMCJ8.0A	1SMC8.0AT3		4-1-65
SMCJ8.5	1SMC8.5AT3		4-1-65
SMCJ8.5A	1SMC8.5AT3		4-1-65
SMCJ9.0	1SMC9.0AT3		4-1-65
SMCJ9.0A	1SMC9.0AT3		4-1-65
SMMJ10		1SMC10AT3	4-1-65
SMMJ10A		1SMC10AT3	4-1-65
SMMJ11		1SMC11AT3	4-1-65
SMMJ11A		1SMC11AT3	4-1-65
SMMJ12		1SMC12AT3	4-1-65
SMMJ12A		1SMC12AT3	4-1-65
SMMJ13		1SMC13AT3	4-1-65
SMMJ13A		1SMC13AT3	4-1-65
SMMJ14		1SMC14AT3	4-1-65
SMMJ14A		1SMC14AT3	4-1-65
SMMJ15		1SMC15AT3	4-1-65
SMMJ15A		1SMC15AT3	4-1-65
SMMJ16		1SMC16AT3	4-1-65
SMMJ16A		1SMC16AT3	4-1-65
SMMJ17		1SMC17AT3	4-1-65
SMMJ17A		1SMC17AT3	4-1-65
SMMJ18		1SMC18AT3	4-1-65
SMMJ18A		1SMC18AT3	4-1-65
SMMJ20		1SMC20AT3	4-1-65
SMMJ20A		1SMC20AT3	4-1-65
SMMJ22		1SMC22AT3	4-1-65
SMMJ22A		1SMC22AT3	4-1-65
SMMJ24		1SMC24AT3	4-1-65
SMMJ24A		1SMC24AT3	4-1-65
SMMJ26		1SMC26AT3	4-1-65
SMMJ26A		1SMC26AT3	4-1-65
SMMJ28		1SMC28AT3	4-1-65
SMMJ28A		1SMC28AT3	4-1-65
SMMJ30		1SMC30AT3	4-1-65
SMMJ30A		1SMC30AT3	4-1-65
SMMJ33		1SMC33AT3	4-1-65
SMMJ33A		1SMC33AT3	4-1-65
SMMJ36		1SMC36AT3	4-1-65
SMMJ36A		1SMC36AT3	4-1-65
SMMJ40		1SMC40AT3	4-1-65
SMMJ40A		1SMC40AT3	4-1-65
SMMJ43		1SMC43AT3	4-1-65
SMMJ43A		1SMC43AT3	4-1-65
SMMJ45		1SMC45AT3	4-1-65
SMMJ45A		1SMC45AT3	4-1-65

CF = consult factory representative

CROSS-REFERENCE (continued)

Industry Part Number	Motorola Direct Replacement	Motorola Similar Replacement	Page Number	Industry Part Number	Motorola Direct Replacement	Motorola Similar Replacement	Page Number
SMMJ48		1SMC48AT3	4-1-65	SMSJ14A		1SMB14AT3	4-1-59
SMMJ48A		1SMC48AT3	4-1-65	SMSJ15		1SMB15AT3	4-1-59
SMMJ5.0		1SMC5.0AT3	4-1-65	SMSJ150		1SMB150AT3	4-1-59
SMMJ5.0A		1SMC5.0AT3	4-1-65	SMSJ150A		1SMB150AT3	4-1-59
SMMJ51		1SMC51AT3	4-1-65	SMSJ15A		1SMB15AT3	4-1-59
SMMJ51A		1SMC51AT3	4-1-65	SMSJ16		1SMB16AT3	4-1-59
SMMJ54		1SMC54AT3	4-1-65	SMSJ160		1SMB160AT3	4-1-59
SMMJ54A		1SMC54AT3	4-1-65	SMSJ160A		1SMB160AT3	4-1-59
SMMJ58		1SMC58AT3	4-1-65	SMSJ16A		1SMB16AT3	4-1-59
SMMJ58A		1SMC58AT3	4-1-65	SMSJ17		1SMB17AT3	4-1-59
SMMJ6.0		1SMC6.0AT3	4-1-65	SMSJ170		1SMB170AT3	4-1-59
SMMJ6.0A		1SMC6.0AT3	4-1-65	SMSJ170A		1SMB170AT3	4-1-59
SMMJ6.5		1SMC6.5AT3	4-1-65	SMSJ17A		1SMB17AT3	4-1-59
SMMJ6.5A		1SMC6.5AT3	4-1-65	SMSJ18		1SMB18AT3	4-1-59
SMMJ60		1SMC60AT3	4-1-65	SMSJ18A		1SMB18AT3	4-1-59
SMMJ60A		1SMC60AT3	4-1-65	SMSJ20		1SMB20AT3	4-1-59
SMMJ64		1SMC64AT3	4-1-65	SMSJ20A		1SMB20AT3	4-1-59
SMMJ64A		1SMC64AT3	4-1-65	SMSJ22		1SMB22AT3	4-1-59
SMMJ7.0		1SMC7.0AT3	4-1-65	SMSJ22A		1SMB22AT3	4-1-59
SMMJ7.0A		1SMC7.0AT3	4-1-65	SMSJ24		1SMB24AT3	4-1-59
SMMJ7.5		1SMC7.5AT3	4-1-65	SMSJ24A		1SMB24AT3	4-1-59
SMMJ7.5A		1SMC7.5AT3	4-1-65	SMSJ26		1SMB26AT3	4-1-59
SMMJ70		1SMC70AT3	4-1-65	SMSJ26A		1SMB26AT3	4-1-59
SMMJ70A		1SMC70AT3	4-1-65	SMSJ28		1SMB28AT3	4-1-59
SMMJ75		1SMC75AT3	4-1-65	SMSJ28A		1SMB28AT3	4-1-59
SMMJ75A		1SMC75AT3	4-1-65	SMSJ30		1SMB30AT3	4-1-59
SMMJ78		1SMC78AT3	4-1-65	SMSJ30A		1SMB30AT3	4-1-59
SMMJ78A		1SMC78AT3	4-1-65	SMSJ33		1SMB33AT3	4-1-59
SMMJ8.0		1SMC8.0AT3	4-1-65	SMSJ33A		1SMB33AT3	4-1-59
SMMJ8.0A		1SMC8.0AT3	4-1-65	SMSJ36		1SMB36AT3	4-1-59
SMMJ8.5		1SMC8.5AT3	4-1-65	SMSJ36A		1SMB36AT3	4-1-59
SMMJ8.5A		1SMC8.5AT3	4-1-65	SMSJ40		1SMB40AT3	4-1-59
SMMJ9.0		1SMC9.0AT3	4-1-65	SMSJ40A		1SMB40AT3	4-1-59
SMMJ9.0A		1SMC9.0AT3	4-1-65	SMSJ43		1SMB43AT3	4-1-59
SMSJ10		1SMB10AT3	4-1-59	SMSJ43A		1SMB43AT3	4-1-59
SMSJ100		1SMB100AT3	4-1-59	SMSJ45		1SMB45AT3	4-1-59
SMSJ100A		1SMB100AT3	4-1-59	SMSJ45A		1SMB45AT3	4-1-59
SMSJ10A		1SMB10AT3	4-1-59	SMSJ48		1SMB48AT3	4-1-59
SMSJ11		1SMB11AT3	4-1-59	SMSJ48A		1SMB48AT3	4-1-59
SMSJ110		1SMB110AT3	4-1-59	SMSJ5.0		1SMB5.0AT3	4-1-59
SMSJ110A		1SMB110AT3	4-1-59	SMSJ5.0A		1SMB5.0AT3	4-1-59
SMSJ11A		1SMB11AT3	4-1-59	SMSJ51		1SMB51AT3	4-1-59
SMSJ12		1SMB12AT3	4-1-59	SMSJ51A		1SMB51AT3	4-1-59
SMSJ120		1SMB120AT3	4-1-59	SMSJ54		1SMB54AT3	4-1-59
SMSJ120A		1SMB120AT3	4-1-59	SMSJ54A		1SMB54AT3	4-1-59
SMSJ12A		1SMB12AT3	4-1-59	SMSJ58		1SMB58AT3	4-1-59
SMSJ13		1SMB13AT3	4-1-59	SMSJ58A		1SMB58AT3	4-1-59
SMSJ130		1SMB130AT3	4-1-59	SMSJ6.0		1SMB6.0AT3	4-1-59
SMSJ130A		1SMB130AT3	4-1-59	SMSJ6.0A		1SMB6.0AT3	4-1-59
SMSJ13A		1SMB13AT3	4-1-59	SMSJ6.5		1SMB6.5AT3	4-1-59
SMSJ14		1SMB14AT3	4-1-59	SMSJ6.5A		1SMB6.5AT3	4-1-59

CF = consult factory representative



CROSS-REFERENCE (continued)

Industry Part Number	Motorola Direct Replacement	Motorola Similar Replacement	Page Number
SMSJ60		1SMB60AT3	4-1-59
SMSJ60A		1SMB60AT3	4-1-59
SMSJ64		1SMB64AT3	4-1-59
SMSJ64A		1SMB64AT3	4-1-59
SMSJ7.0		1SMB7.0AT3	4-1-59
SMSJ7.0A		1SMB7.0AT3	4-1-59
SMSJ7.5		1SMB7.5AT3	4-1-59
SMSJ7.5A		1SMB7.5AT3	4-1-59
SMSJ70		1SMB70AT3	4-1-59
SMSJ70A		1SMB70AT3	4-1-59
SMSJ75		1SMB75AT3	4-1-59
SMSJ75A		1SMB75AT3	4-1-59
SMSJ78		1SMB78AT3	4-1-59
SMSJ78A		1SMB78AT3	4-1-59
SMSJ8.0		1SMB8.0AT3	4-1-59
SMSJ8.0A		1SMB8.0AT3	4-1-59
SMSJ8.5		1SMB8.5AT3	4-1-59
SMSJ8.5A		1SMB8.5AT3	4-1-59
SMSJ85		1SMB85AT3	4-1-59
SMSJ85A		1SMB85AT3	4-1-59
SMSJ9.0		1SMB9.0AT3	4-1-59
SMSJ9.0A		1SMB9.0AT3	4-1-59
SMSJ90		1SMB90AT3	4-1-59
SMSJ90A		1SMB90AT3	4-1-59
SMZJ3789A		1SMB5925BT3	4-2-78
SMZJ3789B		1SMB5925BT3	4-2-78
SMZJ3790A		1SMB5926BT3	4-2-78
SMZJ3790B		1SMB5926BT3	4-2-78
SMZJ3791A		1SMB5927BT3	4-2-78
SMZJ3791B		1SMB5927BT3	4-2-78
SMZJ3792A		1SMB5928BT3	4-2-78
SMZJ3792B		1SMB5928BT3	4-2-78
SMZJ3793A		1SMB5929BT3	4-2-79
SMZJ3793B		1SMB5929BT3	4-2-79
SMZJ3794A		1SMB5930BT3	4-2-79
SMZJ3794B		1SMB5930BT3	4-2-79
SMZJ3795A		1SMB5931BT3	4-2-79
SMZJ3795B		1SMB5931BT3	4-2-79
SMZJ3796A		1SMB5932BT3	4-2-79
SMZJ3796B		1SMB5932BT3	4-2-79
SMZJ3797A		1SMB5933BT3	4-2-79
SMZJ3797B		1SMB5933BT3	4-2-79
SMZJ3798A		1SMB5934BT3	4-2-79
SMZJ3798B		1SMB5934BT3	4-2-79
SMZJ3799A		1SMB5935BT3	4-2-79
SMZJ3799B		1SMB5935BT3	4-2-79
SMZJ3800A		1SMB5936BT3	4-2-79
SMZJ3800B		1SMB5936BT3	4-2-79
SMZJ3801A		1SMB5937BT3	4-2-79
SMZJ3801B		1SMB5937BT3	4-2-79
SMZJ3802A		1SMB5938BT3	4-2-79

Industry Part Number	Motorola Direct Replacement	Motorola Similar Replacement	Page Number
SMZJ3802B		1SMB5938BT3	4-2-79
SMZJ3803A		1SMB5939BT3	4-2-79
SMZJ3803B		1SMB5939BT3	4-2-79
SMZJ3804A		1SMB5940BT3	4-2-79
SMZJ3804B		1SMB5940BT3	4-2-79
SMZJ3805A		1SMB5941BT3	4-2-79
SMZJ3805A		1SMB5941BT3	4-2-79
SMZJ3806A		1SMB5942BT3	4-2-79
SMZJ3806B		1SMB5942BT3	4-2-79
SMZJ3807A		1SMB5943BT3	4-2-79
SMZJ3807B		1SMB5943BT3	4-2-79
SMZJ3808A		1SMB5944BT3	4-2-79
SMZJ3808B		1SMB5944BT3	4-2-79
SMZJ3809A		1SMB5945BT3	4-2-79
SMZJ3809B		1SMB5945BT3	4-2-79
SMZJ5347A,B		P6SMB10AT3	4-1-60
SMZJ5348A,B		P6SMB11AT3	4-1-60
SMZJ5349A,B		P6SMB12AT3	4-1-60
SMZJ5350A,B		P6SMB13AT3	4-1-60
SMZJ5351A,B		P6SMB15AT3	4-1-60
SMZJ5352A,B		P6SMB15AT3	4-1-60
SMZJ5353A,B		P6SMB16AT3	4-1-60
SMZJ5354A,B		P6SMB18AT3	4-1-60
SMZJ5355A,B		P6SMB18AT3	4-1-60
SMZJ5356A,B		P6SMB20AT3	4-1-60
SMZJ5357A,B		P6SMB20AT3	4-1-60
SMZJ5358A,B		P6SMB22AT3	4-1-60
SMZJ5359A,B		P6SMB24AT3	4-1-60
SMZJ5360A,B		P6SMB27AT3	4-1-60
SMZJ5361A,B		P6SMB27AT3	4-1-60
SMZJ5362A,B		P6SMB30AT3	4-1-60
SMZJ5363A,B		P6SMB30AT3	4-1-60
SMZJ5364A,B		P6SMB33AT3	4-1-60
SMZJ5365A,B		P6SMB36AT3	4-1-60
SMZJ5366A,B		P6SMB39AT3	4-1-60
SMZJ5367A,B		P6SMB43AT3	4-1-60
SMZJ5368A,B		P6SMB47AT3	4-1-60
SMZJ5369A,B		P6SMB51AT3	4-1-60
SMZJ5370A,B		P6SMB56AT3	4-1-60
SMZJ5371A,B		P6SMB62AT3	4-1-60
SMZJ5372A,B		P6SMB62AT3	4-1-60
SMZJ5373A,B		P6SMB68AT3	4-1-60
SMZJ5374A,B		P6SMB75AT3	4-1-60
SOV10		SA10A	4-1-26
SOV12		SA12A	4-1-26
SOV15		SA15A	4-1-26
SOV18		SA18A	4-1-26
SOV24		SA26A	4-1-26
SOV28		SA28A	4-1-26
SOV5.0		SA5.0A	4-1-26
TS-7		1N5908	4-1-42

CF = consult factory representative

CROSS-REFERENCE (continued)

Industry Part Number	Motorola Direct Replacement	Motorola Similar Replacement	Page Number
TVS305		SA5.0A	4-1-26
TVS310		SA10A	4-1-26
TVS312		SA12A	4-1-26
TVS315		SA15A	4-1-26
TVS318		SA18A	4-1-26
TVS324		SA24A	4-1-26
TVS328		SA28A	4-1-26
TVS348		SA48A	4-1-27
TVS360		SA60A	4-1-27
TVS410		SA100A	4-1-27
TVS505		SA5.0A	4-1-26
TVS510		SA10A	4-1-26
TVS512		SA12A	4-1-26
TVS515		SA15A	4-1-26
TVS518		SA18A	4-1-26
TVS524		SA24A	4-1-26
TVS528		SA28A	4-1-26
ZPD10	ZPD10		4-2-36
ZPD11	ZPD11		4-2-36
ZPD12	ZPD12		4-2-36
ZPD13	ZPD13		4-2-36
ZPD15	ZPD15		4-2-36
ZPD16	ZPD16		4-2-36

Industry Part Number	Motorola Direct Replacement	Motorola Similar Replacement	Page Number
ZPD18	ZPD18		4-2-36
ZPD2.7	ZPD2.7		4-2-36
ZPD20	ZPD20		4-2-36
ZPD22	ZPD22		4-2-36
ZPD24	ZPD24		4-2-36
ZPD27	ZPD27		4-2-36
ZPD3.0	ZPD3.0		4-2-36
ZPD3.3	ZPD3.3		4-2-36
ZPD3.6	ZPD3.6		4-2-36
ZPD3.9	ZPD3.9		4-2-36
ZPD30	ZPD30		4-2-36
ZPD33	ZPD33		4-2-36
ZPD4.3	ZPD4.3		4-2-36
ZPD4.7	ZPD4.7		4-2-36
ZPD5.1	ZPD5.1		4-2-36
ZPD5.6	ZPD5.6		4-2-36
ZPD6.2	ZPD6.2		4-2-36
ZPD6.8	ZPD6.8		4-2-36
ZPD7.5	ZPD7.5		4-2-36
ZPD8.2	ZPD8.2		4-2-36
ZPD9.1	ZPD9.1		4-2-36

2

CF = consult factory representative

Preferred Part Numbers Guide

3

This guide is the combined list of the Motorola preferred device type numbers from each product category. These are identified as preferred on their respective Data Sheets in Section 4. They are designated as preferred based on sourcing from the die-voltage-package combinations that have had or are expected to have significant volume compared with others in the same product category. The device type number may not be high volume itself but being from a high volume product line improves its odds of being supportable.

Where several device types have similar specifications, for example, 1N5231B and 1N751A, and are selected from the same die-voltage-package combination (5.1V – DO35) the better specified device (1N5231B) is deemed to be the preferred device and recommended for new designs. When a die-voltage-package combination does not have any device types designated as preferred it is because its product line has relatively low volume compared with other product lines in the same wattage-package family.

Since usage levels can change, high volume applications should be discussed with a factory representative before final selection.

TVS/ZENER PREFERRED PARTS LIST

DEVICE TYPE	ZENER BREAK-DOWN VOLTAGE (VOLTS)	POWER RATING	APPLICATION	MOUNTING TYPE	PACKAGE OUTLINE	CASE MATERIAL	PAGE #
1.5KE10CA	10	1.5 kW SURGE	TVS-BIDIR.	AXIAL THRU-HOLE	CASE 41	PLASTIC	4-1-43
1.5KE12CA	12	1.5 kW SURGE	TVS-BIDIR.	AXIAL THRU-HOLE	CASE 41	PLASTIC	4-1-43
1.5KE18CA	18	1.5 kW SURGE	TVS-BIDIR.	AXIAL THRU-HOLE	CASE 41	PLASTIC	4-1-43
1.5KE36CA	36	1.5 kW SURGE	TVS-BIDIR.	AXIAL THRU-HOLE	CASE 41	PLASTIC	4-1-43
1.5SMC36AT3	36	1.5 kW SURGE	TVS-UNIDIR.	SURFACE MOUNTED	SMC	PLASTIC	4-1-66
1.5SMC56AT3	56	1.5 kW SURGE	TVS-UNIDIR.	SURFACE MOUNTED	SMC	PLASTIC	4-1-66
1.5SMC62AT3	62	1.5 kW SURGE	TVS-UNIDIR.	SURFACE MOUNTED	SMC	PLASTIC	4-1-66
1N4689	5.1	500 mWDC	VOLTAGE REG.	AXIAL THRU-HOLE	DO-35	GLASS	4-2-30
1N4728A	3.3	1 WDC	VOLTAGE REG.	AXIAL THRU-HOLE	DO-41	GLASS	4-2-44
1N4731A	4.3	1 WDC	VOLTAGE REG.	AXIAL THRU-HOLE	DO-41	GLASS	4-2-44
1N4732A	4.7	1 WDC	VOLTAGE REG.	AXIAL THRU-HOLE	DO-41	GLASS	4-2-44
1N4733A	5.1	1 WDC	VOLTAGE REG.	AXIAL THRU-HOLE	DO-41	GLASS	4-2-44
1N4734A	5.6	1 WDC	VOLTAGE REG.	AXIAL THRU-HOLE	DO-41	GLASS	4-2-44
1N4735A	6.2	1 WDC	VOLTAGE REG.	AXIAL THRU-HOLE	DO-41	GLASS	4-2-44
1N4736A	6.8	1 WDC	VOLTAGE REG.	AXIAL THRU-HOLE	DO-41	GLASS	4-2-44
1N4738A	8.2	1 WDC	VOLTAGE REG.	AXIAL THRU-HOLE	DO-41	GLASS	4-2-44
1N4739A	9.1	1 WDC	VOLTAGE REG.	AXIAL THRU-HOLE	DO-41	GLASS	4-2-44
1N4740A	10	1 WDC	VOLTAGE REG.	AXIAL THRU-HOLE	DO-41	GLASS	4-2-44
1N4741A	11	1 WDC	VOLTAGE REG.	AXIAL THRU-HOLE	DO-41	GLASS	4-2-44
1N4742A	12	1 WDC	VOLTAGE REG.	AXIAL THRU-HOLE	DO-41	GLASS	4-2-44
1N4743A	13	1 WDC	VOLTAGE REG.	AXIAL THRU-HOLE	DO-41	GLASS	4-2-44
1N4744A	15	1 WDC	VOLTAGE REG.	AXIAL THRU-HOLE	DO-41	GLASS	4-2-44
1N4745A	16	1 WDC	VOLTAGE REG.	AXIAL THRU-HOLE	DO-41	GLASS	4-2-44
1N4746A	18	1 WDC	VOLTAGE REG.	AXIAL THRU-HOLE	DO-41	GLASS	4-2-44
1N4747A	20	1 WDC	VOLTAGE REG.	AXIAL THRU-HOLE	DO-41	GLASS	4-2-44
1N4749A	24	1 WDC	VOLTAGE REG.	AXIAL THRU-HOLE	DO-41	GLASS	4-2-44
1N4750A	27	1 WDC	VOLTAGE REG.	AXIAL THRU-HOLE	DO-41	GLASS	4-2-44
1N4751A	30	1 WDC	VOLTAGE REG.	AXIAL THRU-HOLE	DO-41	GLASS	4-2-44
1N5221B	2.4	500 mWDC	VOLTAGE REG.	AXIAL THRU-HOLE	DO-35	GLASS	4-2-31
1N5223B	2.7	500 mWDC	VOLTAGE REG.	AXIAL THRU-HOLE	DO-35	GLASS	4-2-31
1N5226B	3.3	500 mWDC	VOLTAGE REG.	AXIAL THRU-HOLE	DO-35	GLASS	4-2-31
1N5228B	3.9	500 mWDC	VOLTAGE REG.	AXIAL THRU-HOLE	DO-35	GLASS	4-2-31
1N5229B	4.3	500 mWDC	VOLTAGE REG.	AXIAL THRU-HOLE	DO-35	GLASS	4-2-31

* MAXIMUM REVERSE STAND-OFF VOLTAGE

TVS/ZENER PREFERRED PARTS LIST

DEVICE TYPE	ZENER BREAK-DOWN VOLTAGE (VOLTS)	POWER RATING	APPLICATION	MOUNTING TYPE	PACKAGE OUTLINE	CASE MATERIAL	PAGE #
1N5230B	4.7	500 mWDC	VOLTAGE REG.	AXIAL THRU-HOLE	DO-35	GLASS	4-2-31
1N5231B	5.1	500 mWDC	VOLTAGE REG.	AXIAL THRU-HOLE	DO-35	GLASS	4-2-31
1N5232B	5.6	500 mWDC	VOLTAGE REG.	AXIAL THRU-HOLE	DO-35	GLASS	4-2-31
1N5233B	6	500 mWDC	VOLTAGE REG.	AXIAL THRU-HOLE	DO-35	GLASS	4-2-31
1N5234B	6.2	500 mWDC	VOLTAGE REG.	AXIAL THRU-HOLE	DO-35	GLASS	4-2-31
1N5235B	6.8	500 mWDC	VOLTAGE REG.	AXIAL THRU-HOLE	DO-35	GLASS	4-2-31
1N5236B	7.5	500 mWDC	VOLTAGE REG.	AXIAL THRU-HOLE	DO-35	GLASS	4-2-31
1N5237B	8.2	500 mWDC	VOLTAGE REG.	AXIAL THRU-HOLE	DO-35	GLASS	4-2-31
1N5239B	9.1	500 mWDC	VOLTAGE REG.	AXIAL THRU-HOLE	DO-35	GLASS	4-2-31
1N5240B	10	500 mWDC	VOLTAGE REG.	AXIAL THRU-HOLE	DO-35	GLASS	4-2-31
1N5242B	12	500 mWDC	VOLTAGE REG.	AXIAL THRU-HOLE	DO-35	GLASS	4-2-31
1N5243B	13	500 mWDC	VOLTAGE REG.	AXIAL THRU-HOLE	DO-35	GLASS	4-2-31
1N5244B	14	500 mWDC	VOLTAGE REG.	AXIAL THRU-HOLE	DO-35	GLASS	4-2-31
1N5245B	15	500 mWDC	VOLTAGE REG.	AXIAL THRU-HOLE	DO-35	GLASS	4-2-31
1N5246B	16	500 mWDC	VOLTAGE REG.	AXIAL THRU-HOLE	DO-35	GLASS	4-2-31
1N5248B	18	500 mWDC	VOLTAGE REG.	AXIAL THRU-HOLE	DO-35	GLASS	4-2-31
1N5250B	20	500 mWDC	VOLTAGE REG.	AXIAL THRU-HOLE	DO-35	GLASS	4-2-31
1N5252B	24	500 mWDC	VOLTAGE REG.	AXIAL THRU-HOLE	DO-35	GLASS	4-2-31
1N5254B	27	500 mWDC	VOLTAGE REG.	AXIAL THRU-HOLE	DO-35	GLASS	4-2-31
1N5256B	30	500 mWDC	VOLTAGE REG.	AXIAL THRU-HOLE	DO-35	GLASS	4-2-31
1N5257B	33	500 mWDC	VOLTAGE REG.	AXIAL THRU-HOLE	DO-35	GLASS	4-2-31
1N5258B	36	500 mWDC	VOLTAGE REG.	AXIAL THRU-HOLE	DO-35	GLASS	4-2-31
1N5333B	3.3	5 WDC	VOLTAGE REG.	AXIAL THRU-HOLE	CASE 17	PLASTIC	4-2-59
1N5338B	5.1	5 WDC	VOLTAGE REG.	AXIAL THRU-HOLE	CASE 17	PLASTIC	4-2-59
1N5339B	5.6	5 WDC	VOLTAGE REG.	AXIAL THRU-HOLE	CASE 17	PLASTIC	4-2-59
1N5342B	6.8	5 WDC	VOLTAGE REG.	AXIAL THRU-HOLE	CASE 17	PLASTIC	4-2-59
1N5343B	7.5	5 WDC	VOLTAGE REG.	AXIAL THRU-HOLE	CASE 17	PLASTIC	4-2-59
1N5344B	8.2	5 WDC	VOLTAGE REG.	AXIAL THRU-HOLE	CASE 17	PLASTIC	4-2-59
1N5347B	10	5 WDC	VOLTAGE REG.	AXIAL THRU-HOLE	CASE 17	PLASTIC	4-2-59
1N5349B	12	5 WDC	VOLTAGE REG.	AXIAL THRU-HOLE	CASE 17	PLASTIC	4-2-59
1N5350B	13	5 WDC	VOLTAGE REG.	AXIAL THRU-HOLE	CASE 17	PLASTIC	4-2-59
1N5352B	15	5 WDC	VOLTAGE REG.	AXIAL THRU-HOLE	CASE 17	PLASTIC	4-2-59
1N5353B	16	5 WDC	VOLTAGE REG.	AXIAL THRU-HOLE	CASE 17	PLASTIC	4-2-59
1N5355B	18	5 WDC	VOLTAGE REG.	AXIAL THRU-HOLE	CASE 17	PLASTIC	4-2-59
1N5357B	20	5 WDC	VOLTAGE REG.	AXIAL THRU-HOLE	CASE 17	PLASTIC	4-2-59
1N5359B	24	5 WDC	VOLTAGE REG.	AXIAL THRU-HOLE	CASE 17	PLASTIC	4-2-59

* MAXIMUM REVERSE STAND-OFF VOLTAGE

TVS/ZENER PREFERRED PARTS LIST

DEVICE TYPE	ZENER BREAK-DOWN VOLTAGE (VOLTS)	POWER RATING	APPLICATION	MOUNTING TYPE	PACKAGE OUTLINE	CASE MATERIAL	PAGE #
1N5360B	25	5 WDC	VOLTAGE REG.	AXIAL THRU-HOLE	CASE 17	PLASTIC	4-2-59
1N5361B	27	5 WDC	VOLTAGE REG.	AXIAL THRU-HOLE	CASE 17	PLASTIC	4-2-59
1N5363B	30	5 WDC	VOLTAGE REG.	AXIAL THRU-HOLE	CASE 17	PLASTIC	4-2-59
1N5364B	33	5 WDC	VOLTAGE REG.	AXIAL THRU-HOLE	CASE 17	PLASTIC	4-2-59
1N5365B	36	5 WDC	VOLTAGE REG.	AXIAL THRU-HOLE	CASE 17	PLASTIC	4-2-59
1N5366B	39	5 WDC	VOLTAGE REG.	AXIAL THRU-HOLE	CASE 17	PLASTIC	4-2-59
1N5368B	47	5 WDC	VOLTAGE REG.	AXIAL THRU-HOLE	CASE 17	PLASTIC	4-2-59
1N5372B	62	5 WDC	VOLTAGE REG.	AXIAL THRU-HOLE	CASE 17	PLASTIC	4-2-59
1N5383B	150	5 WDC	VOLTAGE REG.	AXIAL THRU-HOLE	CASE 17	PLASTIC	4-2-60
1N5908	5 *	1.5 kW SURGE	TVS-UNIDIR.	AXIAL THRU-HOLE	CASE 41	PLASTIC	4-1-42
1N5918B	5.1	1.5 WDC	VOLTAGE REG.	AXIAL THRU-HOLE	DO-41	PLASTIC	4-2-51
1N5920B	6.2	1.5 WDC	VOLTAGE REG.	AXIAL THRU-HOLE	DO-41	PLASTIC	4-2-51
1N5929B	15	1.5 WDC	VOLTAGE REG.	AXIAL THRU-HOLE	DO-41	PLASTIC	4-2-51
1N5934B	24	1.5 WDC	VOLTAGE REG.	AXIAL THRU-HOLE	DO-41	PLASTIC	4-2-51
1N5936B	30	1.5 WDC	VOLTAGE REG.	AXIAL THRU-HOLE	DO-41	PLASTIC	4-2-51
1N5941B	47	1.5 WDC	VOLTAGE REG.	AXIAL THRU-HOLE	DO-41	PLASTIC	4-2-51
1N5988B	3.3	500 mWDC	VOLTAGE REG.	AXIAL THRU-HOLE	DO-35	GLASS	4-2-33
1N5993B	5.1	500 mWDC	VOLTAGE REG.	AXIAL THRU-HOLE	DO-35	GLASS	4-2-33
1N5994B	5.6	500 mWDC	VOLTAGE REG.	AXIAL THRU-HOLE	DO-35	GLASS	4-2-33
1N5998B	8.2	500 mWDC	VOLTAGE REG.	AXIAL THRU-HOLE	DO-35	GLASS	4-2-33
1N6007B	20	500 mWDC	VOLTAGE REG.	AXIAL THRU-HOLE	DO-35	GLASS	4-2-33
1N6267A	6.8	1.5 kW SURGE	TVS-UNIDIR.	AXIAL THRU-HOLE	CASE 41	PLASTIC	4-1-43
1N6280A	24	1.5 kW SURGE	TVS-UNIDIR.	AXIAL THRU-HOLE	CASE 41	PLASTIC	4-1-43
1N6282A	30	1.5 kW SURGE	TVS-UNIDIR.	AXIAL THRU-HOLE	CASE 41	PLASTIC	4-1-43
1N6283A	33	1.5 kW SURGE	TVS-UNIDIR.	AXIAL THRU-HOLE	CASE 41	PLASTIC	4-1-43
1N6284A	36	1.5 kW SURGE	TVS-UNIDIR.	AXIAL THRU-HOLE	CASE 41	PLASTIC	4-1-43
1N6288A	51	1.5 kW SURGE	TVS-UNIDIR.	AXIAL THRU-HOLE	CASE 41	PLASTIC	4-1-43
1N6290A	62	1.5 kW SURGE	TVS-UNIDIR.	AXIAL THRU-HOLE	CASE 41	PLASTIC	4-1-44
1N6373	5 *	1.5 kW SURGE	TVS-UNIDIR.	AXIAL THRU-HOLE	CASE 41	PLASTIC	4-1-46
1N6376	12 *	1.5 kW SURGE	TVS-UNIDIR.	AXIAL THRU-HOLE	CASE 41	PLASTIC	4-1-46
1N6382	8 *	1.5 kW SURGE	TVS-BIDIR.	AXIAL THRU-HOLE	CASE 41	PLASTIC	4-1-46
1N6385	15 *	1.5 kW SURGE	TVS-BIDIR.	AXIAL THRU-HOLE	CASE 41	PLASTIC	4-1-46
1N821	6.2	400 mWDC	VOLTAGE REF.	AXIAL THRU-HOLE	DO-35	GLASS	4-3-10
1N823	6.2	400 mWDC	VOLTAGE REF.	AXIAL THRU-HOLE	DO-35	GLASS	4-3-10
1N825	6.2	400 mWDC	VOLTAGE REF.	AXIAL THRU-HOLE	DO-35	GLASS	4-3-10
1SMB5918BT3	5.1	1.5 WDC	VOLTAGE REG.	SURFACE MOUNTED	SMB	PLASTIC	4-2-78

* MAXIMUM REVERSE STAND-OFF VOLTAGE

TVS/ZENER PREFERRED PARTS LIST

DEVICE TYPE	ZENER BREAK-DOWN VOLTAGE (VOLTS)	POWER RATING	APPLICATION	MOUNTING TYPE	PACKAGE OUTLINE	CASE MATERIAL	PAGE #
1SMB5920BT3	6.2	1.5 WDC	VOLTAGE REG.	SURFACE MOUNTED	SMB	PLASTIC	4-2-78
1SMB5925BT3	10	1.5 WDC	VOLTAGE REG.	SURFACE MOUNTED	SMB	PLASTIC	4-2-78
1SMB5927BT3	12	1.5 WDC	VOLTAGE REG.	SURFACE MOUNTED	SMB	PLASTIC	4-2-78
1SMB5929BT3	15	1.5 WDC	VOLTAGE REG.	SURFACE MOUNTED	SMB	PLASTIC	4-2-78
1SMB5931BT3	18	1.5 WDC	VOLTAGE REG.	SURFACE MOUNTED	SMB	PLASTIC	4-2-78
1SMB5934BT3	24	1.5 WDC	VOLTAGE REG.	SURFACE MOUNTED	SMB	PLASTIC	4-2-78
1SMB5936BT3	30	1.5 WDC	VOLTAGE REG.	SURFACE MOUNTED	SMB	PLASTIC	4-2-78
BZX84C10L	10	225 mWDC	VOLTAGE REG.	SURFACE MOUNTED	SOT-23	PLASTIC	4-2-65
BZX84C12L	12	225 mWDC	VOLTAGE REG.	SURFACE MOUNTED	SOT-23	PLASTIC	4-2-65
BZX84C15L	15	225 mWDC	VOLTAGE REG.	SURFACE MOUNTED	SOT-23	PLASTIC	4-2-65
BZX84C30L	30	225 mWDC	VOLTAGE REG.	SURFACE MOUNTED	SOT-23	PLASTIC	4-2-65
BZX84C4V7L	4.7	225 mWDC	VOLTAGE REG.	SURFACE MOUNTED	SOT-23	PLASTIC	4-2-65
BZX84C5V1L	5.1	225 mWDC	VOLTAGE REG.	SURFACE MOUNTED	SOT-23	PLASTIC	4-2-65
BZX84C5V6L	5.6	225 mWDC	VOLTAGE REG.	SURFACE MOUNTED	SOT-23	PLASTIC	4-2-65
BZX84C6V2L	6.2	225 mWDC	VOLTAGE REG.	SURFACE MOUNTED	SOT-23	PLASTIC	4-2-65
BZX84C6V8L	6.8	225 mWDC	VOLTAGE REG.	SURFACE MOUNTED	SOT-23	PLASTIC	4-2-65
BZX84C8V2L	8.2	225 mWDC	VOLTAGE REG.	SURFACE MOUNTED	SOT-23	PLASTIC	4-2-65
BZX84C9V1L	9.1	225 mWDC	VOLTAGE REG.	SURFACE MOUNTED	SOT-23	PLASTIC	4-2-65
MLL5231B	5.1	500 mWDC	VOLTAGE REG.	SURF. MT. LEADLESS	DO-34	GLASS	4-2-75
MLL5233B	6	500 mWDC	VOLTAGE REG.	SURF. MT. LEADLESS	DO-34	GLASS	4-2-75
MLL5244B	14	500 mWDC	VOLTAGE REG.	SURF. MT. LEADLESS	DO-34	GLASS	4-2-75
MLL5252B	24	500 mWDC	VOLTAGE REG.	SURF. MT. LEADLESS	DO-34	GLASS	4-2-75
MMBZ5226BL	3.3	225 mWDC	VOLTAGE REG.	SURFACE MOUNTED	SOT-23	PLASTIC	4-2-66
MMBZ5229BL	4.3	225 mWDC	VOLTAGE REG.	SURFACE MOUNTED	SOT-23	PLASTIC	4-2-66
MMBZ5230BL	4.7	225 mWDC	VOLTAGE REG.	SURFACE MOUNTED	SOT-23	PLASTIC	4-2-66
MMBZ5231BL	5.1	225 mWDC	VOLTAGE REG.	SURFACE MOUNTED	SOT-23	PLASTIC	4-2-66
MMBZ5232BL	5.6	225 mWDC	VOLTAGE REG.	SURFACE MOUNTED	SOT-23	PLASTIC	4-2-66
MMBZ5234BL	6.2	225 mWDC	VOLTAGE REG.	SURFACE MOUNTED	SOT-23	PLASTIC	4-2-66
MMBZ5235BL	6.8	225 mWDC	VOLTAGE REG.	SURFACE MOUNTED	SOT-23	PLASTIC	4-2-66
MMBZ5236BL	7.5	225 mWDC	VOLTAGE REG.	SURFACE MOUNTED	SOT-23	PLASTIC	4-2-66
MMBZ5237BL	8.2	225 mWDC	VOLTAGE REG.	SURFACE MOUNTED	SOT-23	PLASTIC	4-2-66
MMBZ5239BL	9.1	225 mWDC	VOLTAGE REG.	SURFACE MOUNTED	SOT-23	PLASTIC	4-2-66
MMBZ5240BL	10	225 mWDC	VOLTAGE REG.	SURFACE MOUNTED	SOT-23	PLASTIC	4-2-66
MMBZ5242BL	12	225 mWDC	VOLTAGE REG.	SURFACE MOUNTED	SOT-23	PLASTIC	4-2-66
MMBZ5245BL	15	225 mWDC	VOLTAGE REG.	SURFACE MOUNTED	SOT-23	PLASTIC	4-2-66
MMBZ5254BL	27	225 mWDC	VOLTAGE REG.	SURFACE MOUNTED	SOT-23	PLASTIC	4-2-66

* MAXIMUM REVERSE STAND-OFF VOLTAGE



TVS/ZENER PREFERRED PARTS LIST

DEVICE TYPE	ZENER BREAK-DOWN VOLTAGE (VOLTS)	POWER RATING	APPLICATION	MOUNTING TYPE	PACKAGE OUTLINE	CASE MATERIAL	PAGE #
MMBZ5255BL	28	225 mWDC	VOLTAGE REG.	SURFACE MOUNTED	SOT-23	PLASTIC	4-2-86
MR2535L	20*	110 A SURGE	TVS-UNIDIR.	AXIAL THRU-HOLE	CASE 194-04	PLASTIC	4-1-48
MZP4733A	5.1	1 WDC	VOLTAGE REG.	AXIAL THRU-HOLE	DO-41	PLASTIC	4-2-56
MZP4735A	6.2	1 WDC	VOLTAGE REG.	AXIAL THRU-HOLE	DO-41	PLASTIC	4-2-56
MZP4744A	15	1 WDC	VOLTAGE REG.	AXIAL THRU-HOLE	DO-41	PLASTIC	4-2-56
MZP4745A	16	1 WDC	VOLTAGE REG.	AXIAL THRU-HOLE	DO-41	PLASTIC	4-2-56
MZP4746A	18	1 WDC	VOLTAGE REG.	AXIAL THRU-HOLE	DO-41	PLASTIC	4-2-56
MZP4749A	24	1 WDC	VOLTAGE REG.	AXIAL THRU-HOLE	DO-41	PLASTIC	4-2-56
MZP4751A	30	1 WDC	VOLTAGE REG.	AXIAL THRU-HOLE	DO-41	PLASTIC	4-2-56
P6KE11CA	11	600 W SURGE	TVS-BIDIR.	AXIAL THRU-HOLE	CASE 17	PLASTIC	4-1-33
P6KE13A	13	600 W SURGE	TVS-UNIDIR.	AXIAL THRU-HOLE	CASE 17	PLASTIC	4-1-33
P6KE15A	15	600 W SURGE	TVS-UNIDIR.	AXIAL THRU-HOLE	CASE 17	PLASTIC	4-1-33
P6KE20CA	20	600 W SURGE	TVS-BIDIR.	AXIAL THRU-HOLE	CASE 17	PLASTIC	4-1-33
P6KE22CA	22	600 W SURGE	TVS-BIDIR.	AXIAL THRU-HOLE	CASE 17	PLASTIC	4-1-33
P6KE27A	27	600 W SURGE	TVS-UNIDIR.	AXIAL THRU-HOLE	CASE 17	PLASTIC	4-1-33
P6KE27CA	27	600 W SURGE	TVS-BIDIR.	AXIAL THRU-HOLE	CASE 17	PLASTIC	4-1-33
P6KE30CA	30	600 W SURGE	TVS-BIDIR.	AXIAL THRU-HOLE	CASE 17	PLASTIC	4-1-33
P6KE33A	33	600 W SURGE	TVS-UNIDIR.	AXIAL THRU-HOLE	CASE 17	PLASTIC	4-1-33
P6KE36A	36	600 W SURGE	TVS-UNIDIR.	AXIAL THRU-HOLE	CASE 17	PLASTIC	4-1-33
P6KE6.8A	6.8	600 W SURGE	TVS-UNIDIR.	AXIAL THRU-HOLE	CASE 17	PLASTIC	4-1-33
P6KE62A	62	600 W SURGE	TVS-UNIDIR.	AXIAL THRU-HOLE	CASE 17	PLASTIC	4-1-33
P6KE7.5CA	7.5	600 W SURGE	TVS-BIDIR.	AXIAL THRU-HOLE	CASE 17	PLASTIC	4-1-33
P6SMB13AT3	13	600 W SURGE	TVS-UNIDIR.	SURFACE MOUNTED	SMB	PLASTIC	4-1-60
P6SMB15AT3	15	600 W SURGE	TVS-UNIDIR.	SURFACE MOUNTED	SMB	PLASTIC	4-1-60
P6SMB27AT3	27	600 W SURGE	TVS-UNIDIR.	SURFACE MOUNTED	SMB	PLASTIC	4-1-60
P6SMB30AT3	30	600 W SURGE	TVS-UNIDIR.	SURFACE MOUNTED	SMB	PLASTIC	4-1-60
P6SMB33AT3	33	600 W SURGE	TVS-UNIDIR.	SURFACE MOUNTED	SMB	PLASTIC	4-1-60
P6SMB36AT3	36	600 W SURGE	TVS-UNIDIR.	SURFACE MOUNTED	SMB	PLASTIC	4-1-60
P6SMB51AT3	51	600 W SURGE	TVS-UNIDIR.	SURFACE MOUNTED	SMB	PLASTIC	4-1-60
P6SMB62AT3	62	600 W SURGE	TVS-UNIDIR.	SURFACE MOUNTED	SMB	PLASTIC	4-1-60
SA12A	12 *	500 W SURGE	TVS-UNIDIR.	AXIAL THRU-HOLE	CASE 59-04	PLASTIC	4-1-26
SA12CA	12 *	500 W SURGE	TVS-BIDIR.	AXIAL THRU-HOLE	CASE 59-04	PLASTIC	4-1-26
SA13A	13 *	500 W SURGE	TVS-UNIDIR.	AXIAL THRU-HOLE	CASE 59-04	PLASTIC	4-1-26
SA13CA	13 *	500 W SURGE	TVS-BIDIR.	AXIAL THRU-HOLE	CASE 59-04	PLASTIC	4-1-26
SA15A	15 *	500 W SURGE	TVS-UNIDIR.	AXIAL THRU-HOLE	CASE 59-04	PLASTIC	4-1-26
SA15CA	15 *	500 W SURGE	TVS-BIDIR.	AXIAL THRU-HOLE	CASE 59-04	PLASTIC	4-1-26

* MAXIMUM REVERSE STAND-OFF VOLTAGE

3

TVS/ZENER PREFERRED PARTS LIST

DEVICE TYPE	ZENER BREAK-DOWN VOLTAGE (VOLTS)	POWER RATING	APPLICATION	MOUNTING TYPE	PACKAGE OUTLINE	CASE MATERIAL	PAGE #
SA18CA	18 *	500 W SURGE	TVS-BIDIR.	AXIAL THRU-HOLE	CASE 59-04	PLASTIC	4-1-26
SA24CA	24 *	500 W SURGE	TVS-BIDIR.	AXIAL THRU-HOLE	CASE 59-04	PLASTIC	4-1-26
SA5.0A	5 *	500 W SURGE	TVS-UNIDIR.	AXIAL THRU-HOLE	CASE 59-04	PLASTIC	4-1-26
SA6.0A	6 *	500 W SURGE	TVS-UNIDIR.	AXIAL THRU-HOLE	CASE 59-04	PLASTIC	4-1-26
SA6.5CA	6.5 *	500 W SURGE	TVS-BIDIR.	AXIAL THRU-HOLE	CASE 59-04	PLASTIC	4-1-26

* MAXIMUM REVERSE STAND-OFF VOLTAGE

NEW ARRANGEMENT/FEATURES

There are four important changes from previous editions of this book.

DATA SHEET SEQUENCE

No longer strictly alphanumeric. Now data sheets are grouped together by category based on application, construction, ratings, etc. Users can now compare devices that are electrical selections from the same basic product. (A master alphanumeric listing is provided in the Index in the front of the book.)

GENERAL DATA SHEETS

Device type series that are just electrical selections from the same basic product are grouped together by category. Technical data and graphs applicable to all the device type series within a category are combined into a General Data Sheet at the beginning of each category.

Following each General Data Sheet are the familiar electrical parameters and limits table for each device type series. Both the General Data Sheet and the electrical table must be considered together.

When a category contains only one device type series, the general data remains within the one data sheet.

PREFERRED DEVICE TYPES

For the first time, preferred device type numbers are designated on the electrical tables. An arrow and bold facing indicates the preferred part based on sourcing from the die-voltage combinations that have had or are expected to have significant volume compared to others in the category. The device type number may not be high volume itself but being from a high volume production line improves its odds of being supportable. Since usage levels can change, high volume applications should be discussed with a factory representative before final selection.

MULTIPLE PACKAGE QUANTITIES (MPQ)

In recent years, customers have been requiring full reel and full box shipments for taped products. Elimination of partial shipments benefits both the customer and the supplier. Motorola has established MPQs on all transient voltage suppressor and zener diode product categories for taped products. All orders and releases must be in whole number multiples of the MPQ set for each product category. At the beginning of each category of data sheets, the MPQ for the various tape options are listed.

Note: MPQs for bulk packaged parts are now being defined.

Selector Guides and Data Sheets

4

SECTION 4.1 TRANSIENT VOLTAGE SUPPRESSORS

4.1

SECTION 4.2 ZENER VOLTAGE REGULATOR DIODES

4.2

SECTION 4.3 ZENER VOLTAGE REFERENCE DIODES

4.3

Each Section includes:

- Selector Guide
- Data Sheet Category Listing
- Alphanumeric Part Numbers Listing
- Data Sheets

NOTE:

Case outlines, footprints, and tape packaging information are separately listed in Section 5, Packaging Information.

4

4.1

Section 4.1

Transient Voltage Suppressors

Section	Page
4.1.1 Selector Guide	4-1-2
4.1.2 Data Sheet Category Listing	4-1-17
4.1.3 Alphanumeric Part Number Listing ...	4-1-18
4.1.4 Data Sheets	4-1-24

Section 4.1.1 Selector Guide

Transient Voltage Suppressors

4

4.1

SELECTOR GUIDE

Transient Voltage Suppressors

General-Purpose

Transient Voltage Suppressors are designed for applications requiring protection of voltage sensitive electronic devices in danger of destruction by high energy voltage transients. Many of the zener voltage regulator diodes are in fact used in circuits as transient voltage suppressors. The purpose of this section is to present the families of Motorola Zeners that are specified with the key transient voltage suppressor parameters and limits, e.g., maximum clamping voltage at maximum surge current rating and working peak reverse (stand-off) voltage.

Selection sequence:

1. select the package type (axial or surface mount)
2. select the peak surge power expected for the application
3. select the working peak reverse stand-off voltage (or the breakdown voltage)
4. select the maximum reverse clamping voltage

Consult the factory for special electrical selections if there is no standard device type available to fit the application.

AXIAL LEADED FOR THRU-HOLE DESIGNS

PEAK POWER DISSIPATION* — 500 WATTS @ 1 ms SURGE (FIGURE 1) — CASE 59-04 (See Section 4.1.4 for complete data)

ELECTRICAL CHARACTERISTICS (T _A = 25°C unless otherwise noted) V _F = 3.5 V Max, I _F = 35 A Pulse (except bidirectional devices).							
Working Peak Reverse Voltage V _{RWM} (Volts)	Device**	Breakdown Voltage		Maximum Reverse Leakage @ I _T Pulse (mA)	Maximum Reverse Surge Current I _{RSM} Figure 1 (Amps)	Maximum Reverse Voltage @ I _{RSM} (Clamping Voltage) V _{RSM} (Volts)	
		V _{BR} (Volts)					
		Min	Max				
5	SA5.0	6.4	7.3	10	600	52	9.6
5	SA5.0A	6.4	7	10	600	54.3	9.2
6	SA6.0	6.67	8.15	10	600	43.9	11.4
6	SA6.0A	6.67	7.37	10	600	48.5	10.3
6.5	SA6.5	7.22	8.82	10	400	40.7	12.3
6.5	SA6.5A	7.22	7.98	10	400	44.7	11.2
7	SA7.0	7.78	9.51	10	150	37.8	13.3
7	SA7.0A	7.78	8.6	10	150	41.7	12
7.5	SA7.5	8.33	10.2	1	50	35	14.3
7.5	SA7.5A	8.33	9.21	1	50	38.8	12.9
8	SA8.0	8.89	10.9	1	25	33.3	15
8	SA8.0A	8.89	9.83	1	25	36.7	13.6
8.5	SA8.5	9.44	11.5	1	5	31.4	15.9
8.5	SA8.5A	9.44	10.4	1	5	34.7	14.4
9	SA9.0	10	12.2	1	1	29.5	16.9
9	SA9.0A	10	11.1	1	1	32.5	15.4
10	SA10	11.1	13.6	1	1	26.6	18.8
10	SA10A	11.1	12.3	1	1	29.4	17
11	SA11	12.2	14.9	1	1	24.9	20.1
11	SA11A	12.2	13.5	1	1	27.4	18.2
12	SA12	13.3	16.3	1	1	22.7	22
12	SA12A	13.3	14.7	1	1	25.1	19.9
13	SA13	14.4	17.6	1	1	21	23.8
13	SA13A	14.4	15.9	1	1	23.2	21.5
14	SA14	15.6	19.1	1	1	19.4	25.8
14	SA14A	15.6	17.2	1	1	21.5	23.2
15	SA15	16.7	20.4	1	1	18.8	26.9
15	SA15A	16.7	18.5	1	1	20.6	24.4
16	SA16	17.8	21.8	1	1	17.6	28.8
16	SA16A	17.8	19.7	1	1	19.2	26
17	SA17	18.9	23.1	1	1	16.4	30.5
17	SA17A	18.9	20.9	1	1	18.1	27.6

* Steady state power dissipation = 3 watt max rating

** For bidirectional types use C or CA suffix. Have cathode polarity band on each end. (consult factory for availability)

(continued)

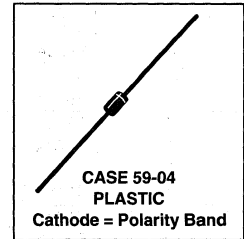

4

4.1

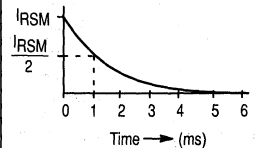

Surge Current Characteristics

Figure 1

SELECTOR GUIDE

AXIAL LEADED FOR THRU-HOLE DESIGNS (continued) (See Section 4.1.4 for complete data)

PEAK POWER DISSIPATION* — 500 WATTS @ 1 ms SURGE (FIGURE 1) — CASE 59-04 (continued)

ELECTRICAL CHARACTERISTICS (T _A = 25°C unless otherwise noted) V _F = 3.5 V Max, I _F = 35 A Pulse (except bidirectional devices).							
Working Peak Reverse Voltage V _{RWM} (Volts)	Device**	Breakdown Voltage			Maximum Reverse Leakage @ V _{RWM} I _R (µA)	Maximum Reverse Surge Current I _{RSM} Figure 1 (Amps)	Maximum Reverse Voltage @ I _{RSM} (Clamping Voltage) V _{RSM} (Volts)
		V _{BR} (Volts)		@ I _T Pulse (mA)			
		Min	Max				
18	SA18	20	24.4	1	1	15.5	32.2
18	SA18A	20	22.1	1	1	17.2	29.2
20	SA20	22.2	27.1	1	1	13.9	35.8
20	SA20A	22.2	24.5	1	1	15.4	32.4
22	SA22	24.4	29.8	1	1	12.7	39.4
22	SA22A	24.4	26.9	1	1	14.1	35.5
24	SA24	26.7	32.6	1	1	11.6	43
24	SA24A	26.7	29.5	1	1	12.8	38.9
26	SA26	28.9	35.3	1	1	10.7	46.6
26	SA26A	28.9	31.9	1	1	11.9	42.1
28	SA28	31.1	38	1	1	9.9	50
28	SA28A	31.1	34.4	1	1	11	45.4
30	SA30	33.3	40.7	1	1	9.3	53.5
30	SA30A	33.3	36.8	1	1	10.3	48.4
33	SA33	36.7	44.9	1	1	8.5	59
33	SA33A	36.7	40.6	1	1	9.4	53.3
36	SA36	40	48.9	1	1	7.8	64.3
36	SA36A	40	44.2	1	1	8.6	58.1
40	SA40	44.4	54.3	1	1	7	71.4
40	SA40A	44.4	49.1	1	1	7.8	64.5
43	SA43	47.8	58.4	1	1	6.5	76.7
43	SA43A	47.8	52.8	1	1	7.2	69.4
45	SA45	50	61.1	1	1	6.2	80.3
45	SA45A	50	55.3	1	1	6.9	72.7
48	SA48	53.3	65.1	1	1	5.8	85.5
48	SA48A	53.3	58.9	1	1	6.5	77.4
51	SA51	56.7	69.3	1	1	5.5	91.1
51	SA51A	56.7	62.7	1	1	6.1	82.4
54	SA54	60	73.3	1	1	5.2	96.3
54	SA54A	60	66.3	1	1	5.7	87.1
58	SA58	64.4	78.7	1	1	4.9	103
58	SA58A	64.4	71.2	1	1	5.3	93.6
60	SA60	66.7	81.5	1	1	4.7	107
60	SA60A	66.7	73.7	1	1	5.2	96.8
64	SA64	71.1	86.9	1	1	4.4	114
64	SA64A	71.1	78.6	1	1	4.9	103
70	SA70	77.8	95.1	1	1	4	125
70	SA70A	77.8	86	1	1	4.4	113
75	SA75	83.3	102	1	1	3.7	134
75	SA75A	83.3	92.1	1	1	4.1	121
78	SA78	86.7	106	1	1	3.6	139
78	SA78A	86.7	95.8	1	1	4	126
85	SA85	94.4	115	1	1	3.3	151
85	SA85A	94.4	104	1	1	3.6	137
90	SA90	100	122	1	1	3.1	160
90	SA90A	100	111	1	1	3.4	146
100	SA100	111	136	1	1	2.8	179
100	SA100A	111	123	1	1	3.1	162

* Steady state power dissipation = 3 watt max rating (continued)
 ** For bidirectional types use C or CA suffix. Have cathode polarity band on each end. (consult factory for availability)

TRANSIENT VOLTAGE SUPPRESSORS AND ZENER DIODES

SELECTOR GUIDE

AXIAL LEADED FOR THRU-HOLE DESIGNS (continued)

PEAK POWER DISSIPATION* — 500 WATTS @ 1 ms SURGE (FIGURE 1) — CASE 59-04 (continued)
 (See Section 4.1.4 for complete data)

ELECTRICAL CHARACTERISTICS (T _A = 25°C unless otherwise noted) V _F = 3.5 V Max, I _F = 35 A Pulse (except bidirectional devices).							
Working Peak Reverse Voltage V _{RWM} (Volts)	Device**	Breakdown Voltage			Maximum Reverse Leakage @ V _{RWM} I _R (μA)	Maximum Reverse Surge Current I _{RSM} Figure 1 (Amps)	Maximum Reverse Voltage @ I _{RSM} (Clamping Voltage) V _{RSM} (Volts)
		V _{BR} (Volts)		@ I _T Pulse (mA)			
		Min	Max				
110	SA110	122	149	1	1	2.6	196
110	SA110A	122	135	1	1	2.8	177
120	SA120	133	163	1	1	2.3	214
120	SA120A	133	147	1	1	2.5	193
130	SA130	144	176	1	1	2.2	231
130	SA130A	144	159	1	1	2.4	209
150	SA150	167	204	1	1	1.9	268
150	SA150A	167	185	1	1	2.1	243
160	SA160	178	218	1	1	1.7	287
160	SA160A	178	197	1	1	1.9	259
170	SA170	189	231	1	1	1.6	304
170	SA170A	189	209	1	1	1.8	275

* Steady state power dissipation = 3 watt max rating

** For bidirectional types use C or CA suffix. Have cathode polarity band on each end. (consult factory for availability)

PEAK POWER DISSIPATION* — 600 WATTS @ 1 ms SURGE (FIGURE 1) — CASE 17-02
 (See Section 4.1.4 for complete data)

ELECTRICAL CHARACTERISTICS (T _A = 25°C unless otherwise noted) V _F = 3.5 V Max, I _F = 50 A Pulse (except bidirectional devices).						
Breakdown Voltage**		Device***†	Working Peak Reverse Voltage V _{RWM} (Volts)	Maximum Reverse Leakage @ V _{RWM} I _R (μA)	Maximum Reverse Surge Current I _{RSM} Figure 1 (Amps)	Maximum Reverse Voltage @ I _{RSM} (Clamping Voltage) V _{RSM} (Volts)
V _{BR} (Volts)	@ I _T Pulse					
Nom	(mA)					
6.8	10	P6KE6.8	5.5	1000	56	10.8
6.8	10	P6KE6.8A	5.8	1000	57	10.5
7.5	10	P6KE7.5	6.05	500	51	11.7
7.5	10	P6KE7.5A	6.4	500	53	11.3
8.2	10	P6KE8.2	6.63	200	48	12.5
8.2	10	P6KE8.2A	7.02	200	50	12.1
9.1	1	P6KE9.1	7.37	50	44	13.8
9.1	1	P6KE9.1A	7.78	50	45	13.4
10	1	P6KE10	8.1	10	40	15
10	1	P6KE10A	8.55	10	41	14.5
11	1	P6KE11	8.92	5	37	16.2
11	1	P6KE11A	9.4	5	38	15.6
12	1	P6KE12	9.72	5	35	17.3
12	1	P6KE12A	10.2	5	36	16.7
13	1	P6KE13	10.5	5	32	19
13	1	P6KE13A	11.1	5	33	18.2
15	1	P6KE15	12.1	5	27	22
15	1	P6KE15A	12.8	5	28	21.2
16	1	P6KE16	12.9	5	26	23.5
16	1	P6KE16A	13.6	5	27	22.5
18	1	P6KE18	14.5	5	23	26.5
18	1	P6KE18A	15.3	5	24	25.2
20	1	P6KE20	16.2	5	21	29.1
20	1	P6KE20A	17.1	5	22	27.7

* Steady state power dissipation = 5 watts max rating

(continued)

** Breakdown voltage tolerance is ±10% for no suffix, and ±5% for A suffix

*** For bidirectional types use C or CA suffix. Have cathode polarity band on each end. (consult factory for availability)

† UL recognition for classification of protectors (QVG2) under the UL standard for safety 497B for entire series including C & CA suffixes.

4

4.1

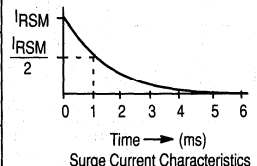
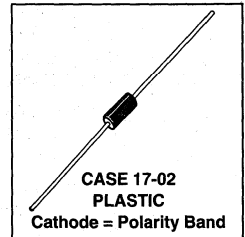

Figure 1

SELECTOR GUIDE

AXIAL LEADED FOR THRU-HOLE DESIGNS (continued) (See Section 4.1.4 for complete data)

PEAK POWER DISSIPATION* — 600 WATTS @ 1 ms SURGE (FIGURE 1) — CASE 17-02 (continued)

ELECTRICAL CHARACTERISTICS (T _A = 25°C unless otherwise noted) V _F = 3.5 V Max, I _F = 50 A Pulse (except bidirectional devices).						
Breakdown Voltage**		Device***†	Working Peak Reverse Voltage V _{RWM} (Volts)	Maximum Reverse Leakage @ V _{RWM} I _R (µA)	Maximum Reverse Surge Current I _{RSM} Figure 1 (Amps)	Maximum Reverse Voltage @ I _{RSM} (Clamping Voltage) V _{RSM} (Volts)
VBR (Volts)	@ I _T Pulse (mA)					
Nom						
22	1	P6KE22	17.8	5	19	31.9
22	1	P6KE22A	18.8	5	20	30.6
24	1	P6KE24	19.4	5	17	34.7
24	1	P6KE24A	20.5	5	18	33.2
27	1	P6KE27	21.8	5	15	39.1
27	1	P6KE27A	23.1	5	16	37.5
30	1	P6KE30	24.3	5	14	43.5
30	1	P6KE30A	25.6	5	14.4	41.4
33	1	P6KE33	26.8	5	12.6	47.7
33	1	P6KE33A	28.2	5	13.2	45.7
36	1	P6KE36	29.1	5	11.6	52
36	1	P6KE36A	30.8	5	12	49.9
39	1	P6KE39	31.6	5	10.6	56.4
39	1	P6KE39A	33.3	5	11.2	53.9
43	1	P6KE43	34.8	5	9.6	61.9
43	1	P6KE43A	36.8	5	10.1	59.3
47	1	P6KE47	38.1	5	8.9	67.8
47	1	P6KE47A	40.2	5	9.3	64.8
51	1	P6KE51	41.3	5	8.2	73.5
51	1	P6KE51A	43.6	5	8.6	70.1
56	1	P6KE56	45.4	5	7.4	80.5
56	1	P6KE56A	47.8	5	7.8	77
62	1	P6KE62	50.2	5	6.8	89
62	1	P6KE62A	53	5	7.1	85
68	1	P6KE68	55.1	5	6.1	98
68	1	P6KE68A	58.1	5	6.5	92
75	1	P6KE75	60.7	5	5.5	108
75	1	P6KE75A	64.1	5	5.8	103
82	1	P6KE82	66.4	5	5.1	118
82	1	P6KE82A	70.1	5	5.3	113
91	1	P6KE91	73.7	5	4.5	131
91	1	P6KE91A	77.8	5	4.8	125
100	1	P6KE100	81	5	4.2	144
100	1	P6KE100A	85.5	5	4.4	137
110	1	P6KE110	89.2	5	3.8	158
110	1	P6KE110A	94	5	4	152
120	1	P6KE120	97.2	5	3.5	173
120	1	P6KE120A	102	5	3.6	165
130	1	P6KE130	105	5	3.2	187
130	1	P6KE130A	111	5	3.3	179

* Steady state power dissipation = 5 watts max rating

(continued)

** Breakdown voltage tolerance is ±10% for no suffix and ±5% for A suffix

*** For bidirectional types use C or CA suffix. Have cathode polarity band on each end. (consult factory for availability)

† UL recognition for classification of protectors (QVGV2) under the UL standard for safety 497B for entire series including C & CA suffixes.

SELECTOR GUIDE

AXIAL LEADED FOR THRU-HOLE DESIGNS (continued) (See Section 4.1.4 for complete data)

PEAK POWER DISSIPATION* — 600 WATTS @ 1 ms SURGE (FIGURE 1) — CASE 17-02 (continued)

ELECTRICAL CHARACTERISTICS ($T_A = 25^\circ\text{C}$ unless otherwise noted) $V_F = 3.5\text{ V Max}$, $I_F = 50\text{ A Pulse}$ (except bidirectional devices).						
Breakdown Voltage**		Device***†	Working Peak Reverse Voltage V_{RWM} (Volts)	Maximum Reverse Leakage @ V_{RWM} I_R (μA)	Maximum Reverse Surge Current I_{RSM} Figure 1 (Amps)	Maximum Reverse Voltage @ I_{RSM} (Clamping Voltage) V_{RSM} (Volts)
V_{BR} (Volts)	@ I_T Pulse (mA)					
Nom						
150	1	P6KE150	121	5	2.8	215
150	1	P6KE150A	128	5	2.9	207
160	1	P6KE160	130	5	2.6	230
160	1	P6KE160A	136	5	2.7	219
170	1	P6KE170	138	5	2.5	244
170	1	P6KE170A	145	5	2.6	234
180	1	P6KE180	146	5	2.3	258
180	1	P6KE180A	154	5	2.4	246
200	1	P6KE200	162	5	2.1	287
200	1	P6KE200A	171	5	2.2	274

* Steady state power dissipation = 5 watts max rating

** Breakdown voltage tolerance is $\pm 10\%$ for no suffix and $\pm 5\%$ for A suffix

*** For bidirectional types use C or CA suffix. Have cathode polarity band on each end. (consult factory for availability)

† UL recognition for classification of protectors (QVGV2) under the UL standard for safety 497B for entire series including C & CA suffixes.

SELECTOR GUIDE

AXIAL LEADED FOR THRU-HOLE DESIGNS (continued) (See Section 4.1.4 for complete data)

PEAK POWER DISSIPATION* — 1500 WATTS @ 1 ms SURGE (FIGURE 1) — CASE 41A-02

ELECTRICAL CHARACTERISTICS (T _A = 25°C unless otherwise noted) V _F = 3.5 V Max, I _F = 100 A Pulse (C suffix denotes standard back to back bidirectional versions. Test both polarities)									
Maximum Reverse Stand-Off Voltage V _{RWM} (Volts)	JEDEC** Device	Device**	Breakdown Voltage		Maximum Reverse Leakage @ V _{RWM} I _R (μA)	Maximum Reverse Surge Current Figure 1 I _{RSM} (Amps)	Maximum Reverse Voltage @ I _{RSM} (Clamping Voltage) V _{RSM} (Volts)	Clamping Voltage***	
			V _{BR} Volts Min	@ I _T Pulse (mA)				Peak Pulse Current @ I _{pp1} = 1 A Figure 1 V _{C1} (Volts max)	Peak Pulse Current @ I _{pp2} = 10 A Figure 1 V _{C2} (Volts max)
5	1N5908		6	1	300	120	8.5	7.6 @ 30 A	8 @ 60 A
5	1N6373	ICTE-5/MPTE-5	6	1	300	160	9.4	7.1	7.5
8	1N6374	ICTE-8/MPTE-8	9.4	1	25	100	15	11.3	11.5
8	1N6382	ICTE-8C/MPTE-8C	9.4	1	25	100	15	11.4	11.6
10	1N6375	ICTE-10/MPTE-10	11.7	1	2	90	16.7	13.7	14.1
10	1N6383	ICTE-10C/MPTE-10C	11.7	1	2	90	16.7	14.1	14.5
12	1N6376	ICTE-12/MPTE-12	14.1	1	2	70	21.2	16.1	16.5
12	1N6384	ICTE-12C/MPTE-12C	14.1	1	2	70	21.2	16.7	17.1
15	1N6377	ICTE-15/MPTE-15	17.6	1	2	60	25	20.1	20.6
15	1N6385	ICTE-15C/MPTE-15C	17.6	1	2	60	25	20.8	21.4
18	1N6378	ICTE-18/MPTE-18	21.2	1	2	50	30	24.2	25.2
18	1N6386	ICTE-18C/MPTE-18C	21.2	1	2	50	30	24.8	25.5
22	1N6379	ICTE-22/MPTE-22	25.9	1	2	40	37.5	29.8	32
22	1N6387	ICTE-22C/MPTE-22C	25.9	1	2	40	37.5	30.8	32
36	1N6380	ICTE-36/MPTE-36	42.4	1	2	23	65.2	50.6	54.3
36	1N6388	ICTE-36C/MPTE-36C	42.4	1	2	23	65.2	50.6	54.3
45	1N6381	ICTE-45/MPTE-45	52.9	1	2	19	78.9	63.3	70
45	1N6389	ICTE-45C/MPTE-45C	52.9	1	2	19	78.9	63.3	70

4

4.1

* Steady state power dissipation = 5 watts max rating.
 *** 1N6382 thru 1N6389 and C suffix ICTE/MPTE device types are bidirectional. Have cathode polarity band on each end. All other device types are unidirectional only. (Consult factory for availability).
 *** Clamping voltage peak pulse currents for 1N5908 are 30 Amps and 60 Amps.

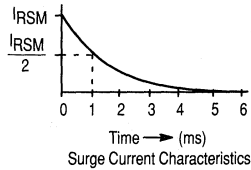
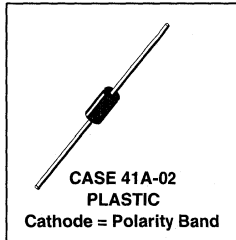

Figure 1

SELECTOR GUIDE

AXIAL LEADED FOR THRU-HOLE DESIGNS (continued) (See Section 4.1.4 for complete data)

PEAK POWER DISSIPATION* — 1500 WATTS @ 1 ms SURGE (FIGURE 1) — CASE 41A-02

ELECTRICAL CHARACTERISTICS (T _A = 25°C unless otherwise noted) V _F = 3.5 V Max, I _F = 100 A Pulse							
Breakdown Voltage**		JEDEC Device	Device***†	Working Peak Reverse Voltage V _{RWM} (Volts)	Maximum Reverse Leakage @ V _{RWM} I _R (μA)	Maximum Reverse Surge Current Figure 1 I _{RSM} (Amps)	Maximum Reverse Voltage @ I _{RSM} (Clamping Voltage) V _{RSM} (Volts)
V _{BR} Volts	@ I _T Pulse						
Nom	(mA)						
6.8	10	1N6267	1.5KE6.8	5.5	1000	139	10.8
6.8	10	1N6267A	1.5KE6.8A	5.8	1000	143	10.5
7.5	10	1N6268	1.5KE7.5	6.05	500	128	11.7
7.5	10	1N6268A	1.5KE7.5A	6.4	500	132	11.3
8.2	10	1N6269	1.5KE8.2	6.63	200	120	12.5
8.2	10	1N6269A	1.5KE8.2A	7.02	200	124	12.1
9.1	1	1N6270	1.5KE9.1	7.37	50	109	13.8
9.1	1	1N6270A	1.5KE9.1A	7.78	50	112	13.4
10	1	1N6271	1.5KE10	8.1	10	100	15
10	1	1N6271A	1.5KE10A	8.55	10	103	14.5
11	1	1N6272	1.5KE11	8.92	5	93	16.2
11	1	1N6272A	1.5KE11A	9.4	5	96	15.6
12	1	1N6273	1.5KE12	9.72	5	87	17.3
12	1	1N6273A	1.5KE12A	10.2	5	90	16.7
13	1	1N6274	1.5KE13	10.5	5	79	19
13	1	1N6274A	1.5KE13A	11.1	5	82	18.2
15	1	1N6275	1.5KE15	12.1	5	68	22
15	1	1N6275A	1.5KE15A	12.8	5	71	21.2
16	1	1N6276	1.5KE16	12.9	5	64	23.5
16	1	1N6276A	1.5KE16A	13.6	5	67	22.5
18	1	1N6277	1.5KE18	14.5	5	56.5	26.5
18	1	1N6277A	1.5KE18A	15.3	5	59.5	25.2
20	1	1N6278	1.5KE20	16.2	5	51.5	29.1
20	1	1N6278A	1.5KE20A	17.1	5	54	27.7
22	1	1N6279	1.5KE22	17.8	5	47	31.9
22	1	1N6279A	1.5KE22A	18.8	5	49	30.6
24	1	1N6280	1.5KE24	19.4	5	43	34.7
24	1	1N6280A	1.5KE24A	20.5	5	45	33.2
27	1	1N6281	1.5KE27	21.8	5	38.5	39.1
27	1	1N6281A	1.5KE27A	23.1	5	40	37.5
30	1	1N6282	1.5KE30	24.3	5	34.5	43.5
30	1	1N6282A	1.5KE30A	25.6	5	36	41.4
33	1	1N6283	1.5KE33	26.8	5	31.5	47.7
33	1	1N6283A	1.5KE33A	28.2	5	33	45.7
36	1	1N6284	1.5KE36	29.1	5	29	52
36	1	1N6284A	1.5KE36A	30.8	5	30	49.9
39	1	1N6285	1.5KE39	31.6	5	26.5	56.4
39	1	1N6285A	1.5KE39A	33.3	5	28	53.9
43	1	1N6286	1.5KE43	34.8	5	24	61.9
43	1	1N6286A	1.5KE43A	36.8	5	25.3	59.3
47	1	1N6287	1.5KE47	38.1	5	22.2	67.8
47	1	1N6287A	1.5KE47A	40.2	5	23.2	64.8
51	1	1N6288	1.5KE51	41.3	5	20.4	73.5
51	1	1N6288A	1.5KE51A	43.6	5	21.4	70.1

* Steady state power dissipation = 5 watts max rating

(continued)

** Breakdown voltage tolerance is ±10% for no suffix and ±5% for A suffix

*** For bidirectional types use C or CA suffix on 1.5KE series only. Have cathode polarity band on each end. Consult factory for availability.

† (1N6267-6303A series do not have C or CA option).

‡ UL recognition for classification of protectors (QVG2) under the UL standard for safety 497B for 1.5KE6.8,A,C,CA thru 1.5KE250,A,C,CA.

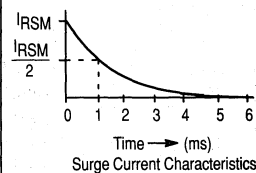
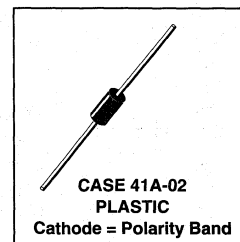

Figure 1

4

4.1

SELECTOR GUIDE

AXIAL LEADED FOR THRU-HOLE DESIGNS (continued) (See Section 4.1.4 for complete data)

PEAK POWER DISSIPATION* — 1500 WATTS @ 1 ms SURGE (FIGURE 1) — CASE 41A-02 (continued)

ELECTRICAL CHARACTERISTICS — continued ($T_A = 25^\circ\text{C}$ unless otherwise noted) $V_F = 3.5\text{ V Max}$, $I_F = 100\text{ A Pulse}$							
Breakdown Voltage**		JEDEC Device	Device***†	Working Peak Reverse Voltage V_{RWM} (Volts)	Maximum Reverse Leakage @ V_{RWM} I_R (μA)	Maximum Reverse Surge Current Figure 1 I_{RSM} (Amps)	Maximum Reverse Voltage @ I_{RSM} (Clamping Voltage) V_{RSM} (Volts)
V_{BR} Volts	@ I_T Pulse (mA)						
Nom							
56	1	1N6289	1.5KE56	45.4	5	18.6	80.5
56	1	1N6289A	1.5KE56A	47.8	5	19.5	77
62	1	1N6290	1.5KE62	50.2	5	16.9	89
62	1	1N6290A	1.5KE62A	53	5	17.7	85
68	1	1N6291	1.5KE68	55.1	5	15.3	98
68	1	1N6291A	1.5KE68A	58.1	5	16.3	92
75	1	1N6292	1.5KE75	60.7	5	13.9	108
75	1	1N6292A	1.5KE75A	64.1	5	14.6	103
82	1	1N6293	1.5KE82	66.4	5	12.7	118
82	1	1N6293A	1.5KE82A	70.1	5	13.3	113
91	1	1N6294	1.5KE91	73.7	5	11.4	131
91	1	1N6294A	1.5KE91A	77.8	5	12	125
100	1	1N6295	1.5KE100	81	5	10.4	144
100	1	1N6295A	1.5KE100A	85.5	5	11	137
110	1	1N6296	1.5KE110	89.2	5	9.5	158
110	1	1N6296A	1.5KE110A	94	5	9.9	152
120	1	1N6297	1.5KE120	97.2	5	8.7	173
120	1	1N6297A	1.5KE120A	102	5	9.1	165
130	1	1N6298	1.5KE130	105	5	8	187
130	1	1N6298A	1.5KE130A	111	5	8.4	179
150	1	1N6299	1.5KE150	121	5	7	215
150	1	1N6299A	1.5KE150A	128	5	7.2	207
160	1	1N6300	1.5KE160	130	5	6.5	230
160	1	1N6300A	1.5KE160A	136	5	6.8	219
170	1	1N6301	1.5KE170	138	5	6.2	244
170	1	1N6301A	1.5KE170A	145	5	6.4	234
180	1	1N6302	1.5KE180	146	5	5.8	258
180	1	1N6302A	1.5KE180A	154	5	6.1	246
200	1	1N6303	1.5KE200	162	5	5.2	287
200	1	1N6303A	1.5KE200A	171	5	5.5	274
220	1		1.5KE220	175	5	4.3	344
220	1		1.5KE220A	185	5	4.6	328
250	1		1.5KE250	202	5	5	360
250	1		1.5KE250A	214	5	5	344

* Steady state power dissipation = 5 watts max rating

** Breakdown voltage tolerance is $\pm 10\%$ for no suffix and $\pm 5\%$ for A suffix

*** For bidirectional types use C or CA suffix on 1.5KE series only. Have cathode polarity band on each end. Consult factory for availability. (1N6267-6303A series do not have C or CA option).

† UL recognition for classification of protectors (QVGV2) under the UL standard for safety 497B for 1.5KE6.8,A,C,CA thru 1.5KE250,A,C,CA.

SELECTOR GUIDE

TRANSIENT VOLTAGE SUPPRESSORS (continued)

GENERAL PURPOSE (continued)

Surface Mount Packages

**PEAK POWER DISSIPATION — 40 WATTS @ 1 ms SURGE (FIGURE 1) — CASE 318-07
MMBZ15VDLT1* — SOT-23 BIPOLAR (for ESD protection)
(See Section 4.1.4 for complete data)**

ELECTRICAL CHARACTERISTICS ($T_A = 25^\circ\text{C}$ unless otherwise noted)								
Breakdown Voltage				Working Peak Reverse Voltage V_{RWM} (Volts)	Maximum Reverse Leakage Current I_{RWM} I_R (nA)	Maximum Reverse Surge Current I_{RSM}^\dagger (Amps)	Maximum Reverse Voltage @ I_{RSM}^\dagger (Clamping Voltage) V_{RSM} (Volts)	Maximum Temperature Coefficient of V_{BR} (mV/°C)
$V_{BR}^{\dagger\dagger}$ (Volts)			@ I_T (mA)					
Min	Nom	Max						
14.3	15	15.8	1.0	12.8	100	1.9	21.2	12

† Surge current waveform per Figure 1.
 †† V_{BR} measured at pulse test current I_T at an ambient temperature of 25°C.
 * T1 suffix designates tape and reel of 3000 units.

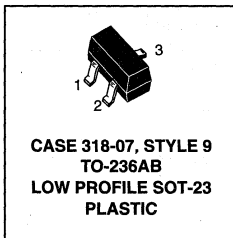

Pinout: Terminal 1 — Anode
 Terminal 2 — Anode
 Terminal 3 — Cathode

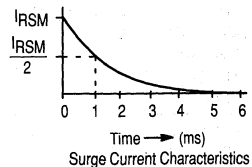
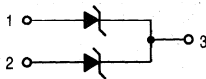

Figure 1

4

4.1

SELECTOR GUIDE

SURFACE MOUNT PACKAGES (continued) (See Section 4.1.4 for complete data)

PEAK POWER DISSIPATION — 600 WATTS @ 1 ms SURGE (FIGURE 1) — CASE 403A-03

ELECTRICAL CHARACTERISTICS (T _A = 25°C unless otherwise noted).							
Reverse Stand-Off Voltage V _R Volts (1)	Device (2)	Breakdown Voltage		Maximum Clamping Voltage V _C @ I _{pp} Volts	Peak Pulse Current (See Figure 1) I _{pp} Amps	Maximum Reverse Leakage @ V _R I _R μA	Device Marking
		V _{BR} @ I _T					
		Volts Min	Pulse mA				
5	1SMB5.0AT3	6.4	10	9.2	65.2	800	KE
6	1SMB6.0AT3	6.67	10	10.3	58.3	800	KG
6.5	1SMB6.5AT3	7.22	10	11.2	53.6	500	KK
7	1SMB7.0AT3	7.78	10	12	50	200	KM
7.5	1SMB7.5AT3	8.33	1	12.9	46.5	100	KP
8	1SMB8.0AT3	8.89	1	13.6	44.1	50	KR
8.5	1SMB8.5AT3	9.44	1	14.4	41.7	10	KT
9	1SMB9.0AT3	10	1	15.4	39	5	KV
10	1SMB10AT3	11.1	1	17	35.3	5	KX
11	1SMB11AT3	12.2	1	18.2	33	5	KZ
12	1SMB12AT3	13.3	1	19.9	30.2	5	LE
13	1SMB13AT3	14.4	1	21.5	27.9	5	LG
14	1SMB14AT3	15.6	1	23.2	25.8	5	LK
15	1SMB15AT3	16.7	1	24.4	24	5	LM
16	1SMB16AT3	17.8	1	26	23.1	5	LP
17	1SMB17AT3	18.9	1	27.6	21.7	5	LR
18	1SMB18AT3	20	1	29.2	20.5	5	LT
20	1SMB20AT3	22.2	1	32.4	18.5	5	LV
22	1SMB22AT3	24.4	1	35.5	16.9	5	LX
24	1SMB24AT3	26.7	1	38.9	15.4	5	LZ
26	1SMB26AT3	28.9	1	42.1	14.2	5	ME
28	1SMB28AT3	31.1	1	45.4	13.2	5	MG
30	1SMB30AT3	33.3	1	48.4	12.4	5	MK
33	1SMB33AT3	36.7	1	53.3	11.3	5	MM
36	1SMB36AT3	40	1	58.1	10.3	5	MP
40	1SMB40AT3	44.4	1	64.5	9.3	5	MR
43	1SMB43AT3	47.8	1	69.4	8.6	5	MT
45	1SMB45AT3	50	1	72.7	8.3	5	MV
48	1SMB48AT3	53.3	1	77.4	7.7	5	MX
51	1SMB51AT3	56.7	1	82.4	7.3	5	MZ
54	1SMB54AT3	60	1	87.1	6.9	5	NE
58	1SMB58AT3	64.4	1	93.6	6.4	5	NG
60	1SMB60AT3	66.7	1	96.8	6.2	5	NK
64	1SMB64AT3	71.1	1	103	5.8	5	NM
70	1SMB70AT3	77.8	1	113	5.3	5	NP
75	1SMB75AT3	83.3	1	121	4.9	5	NR
78	1SMB78AT3	86.7	1	126	4.7	5	NT
85	1SMB85AT3	94.4	1	137	4.4	5	NV
90	1SMB90AT3	100	1	146	4.1	5	NX
100	1SMB100AT3	111	1	162	3.7	5	NZ
110	1SMB110AT3	122	1	177	3.4	5	PE
120	1SMB120AT3	133	1	193	3.1	5	PG
130	1SMB130AT3	144	1	209	2.9	5	PK
150	1SMB150AT3	167	1	243	2.5	5	PM
160	1SMB160AT3	178	1	259	2.3	5	PP
170	1SMB170AT3	189	1	275	2.2	5	PR

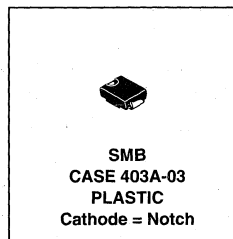

RECOMMENDED SOLDER PAD (FOOTPRINT)

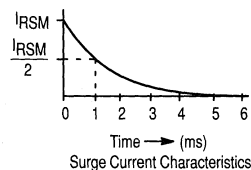
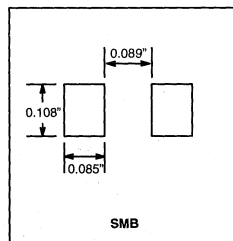

Figure 1

Note 1. A transient suppressor is normally selected according to the reverse "Stand Off Voltage" (V_R) which should be equal to or greater than the DC or continuous peak operating voltage level.

Note 2. T3 suffix designates tape and reel of 2500 units.

SELECTOR GUIDE

SURFACE MOUNT PACKAGES (continued) (See Section 4.1.4 for complete data)

PEAK POWER DISSIPATION — 600 WATTS @ 1 ms SURGE (FIGURE 1) — CASE 403A-03

ELECTRICAL CHARACTERISTICS (T _A = 25°C unless otherwise noted) V _F = 3.5 V Max, I _F = 50 A Pulse.							
Breakdown Voltage*		Device**	Working Peak Reverse Voltage V _{RWM} Volts	Maximum Reverse Leakage @ V _{RWM} I _R (μA)	Maximum Reverse Surge Current Figure 1 I _{RSM} (Amps)	Maximum Reverse Voltage @ I _{RSM} (Clamping Voltage) V _{RSM} (Volts)	Device Marking
V _{BR} @ I _T Pulse Volts							
Nom	mA						
6.8	10	P6SMB6.8AT3	5.8	1000	57	10.5	6V8A
7.5	10	P6SMB7.5AT3	6.4	500	53	11.3	7V5A
8.2	10	P6SMB8.2AT3	7.02	200	50	12.1	8V2A
9.1	1	P6SMB9.1AT3	7.78	50	45	13.4	9V1A
10	1	P6SMB10AT3	8.55	10	41	14.5	10A
11	1	P6SMB11AT3	9.4	5	38	15.6	11A
12	1	P6SMB12AT3	10.2	5	36	16.7	12A
13	1	P6SMB13AT3	11.1	5	33	18.2	13A
15	1	P6SMB15AT3	12.8	5	28	21.2	15A
16	1	P6SMB16AT3	13.6	5	27	22.5	16A
18	1	P6SMB18AT3	15.3	5	24	25.2	18A
20	1	P6SMB20AT3	17.1	5	22	27.7	20A
22	1	P6SMB22AT3	18.8	5	20	30.6	22A
24	1	P6SMB24AT3	20.5	5	18	33.2	24A
27	1	P6SMB27AT3	23.1	5	16	37.5	27A
30	1	P6SMB30AT3	25.6	5	14.4	41.4	30A
33	1	P6SMB33AT3	28.2	5	13.2	45.7	33A
36	1	P6SMB36AT3	30.8	5	12	49.9	36A
39	1	P6SMB39AT3	33.3	5	11.2	53.9	39A
43	1	P6SMB43AT3	36.8	5	10.1	59.3	43A
47	1	P6SMB47AT3	40.2	5	9.3	64.8	47A
51	1	P6SMB51AT3	43.6	5	8.6	70.1	51A
56	1	P6SMB56AT3	47.8	5	7.8	77	56A
62	1	P6SMB62AT3	53	5	7.1	85	62A
68	1	P6SMB68AT3	58.1	5	6.5	92	68A
75	1	P6SMB75AT3	64.1	5	5.8	103	75A
82	1	P6SMB82AT3	70.1	5	5.3	113	82A
91	1	P6SMB91AT3	77.8	5	4.8	125	91A
100	1	P6SMB100AT3	85.5	5	4.4	137	100A
110	1	P6SMB110AT3	94	5	4	152	110A
120	1	P6SMB120AT3	102	5	3.6	165	120A
130	1	P6SMB130AT3	111	5	3.3	179	130A
150	1	P6SMB150AT3	128	5	2.9	207	150A
160	1	P6SMB160AT3	136	5	2.7	219	160A
170	1	P6SMB170AT3	145	5	2.6	234	170A
180	1	P6SMB180AT3	154	5	2.4	246	180A
200	1	P6SMB200AT3	171	5	2.2	274	200A

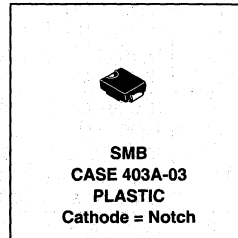

RECOMMENDED SOLDER PAD (FOOTPRINT)

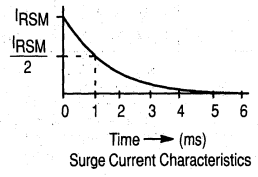
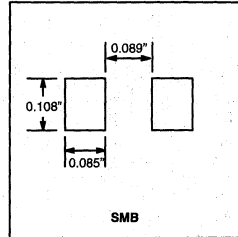

Figure 1

* Breakdown voltage tolerance is ±5% for A suffix.
 ** T3 suffix designates tape and reel of 2500 units.

4
4.1

SELECTOR GUIDE

SURFACE MOUNT PACKAGES (continued) (See Section 4.1.4 for complete data)

PEAK POWER DISSIPATION — 1500 WATTS @ 1 ms SURGE (FIGURE 1) — CASE 403-03

ELECTRICAL CHARACTERISTICS (T _A = 25°C unless otherwise noted)							
Reverse Stand-Off Voltage V _R Volts (1)	Device (2)	Breakdown Voltage		Maximum Clamping Voltage V _C @ I _{pp} Volts	Peak Pulse Current (See Figure 1) I _{pp} Amps	Maximum Reverse Leakage @ V _R I _R μA	Device Marking
		V _{BR} @ I _T					
		Volts Min	Pulse mA				
5	1SMC5.0AT3	6.4	10	9.2	163	1000	GDE
6	1SMC6.0AT3	6.67	10	10.3	145.6	1000	GDG
6.5	1SMC6.5AT3	7.22	10	11.2	133.9	500	GDK
7	1SMC7.0AT3	7.78	10	12	125	200	GDM
7.5	1SMC7.5AT3	8.33	1	12.9	116.3	100	GDP
8	1SMC8.0AT3	8.89	1	13.6	110.3	50	GDR
8.5	1SMC8.5AT3	9.44	1	14.4	104.2	20	GDT
9	1SMC9.0AT3	10	1	15.4	97.4	10	GDV
10	1SMC10AT3	11.1	1	17	88.2	5	GDX
11	1SMC11AT3	12.2	1	18.2	82.4	5	GDZ
12	1SMC12AT3	13.3	1	19.9	75.3	5	GEE
13	1SMC13AT3	14.4	1	21.5	69.7	5	GEG
14	1SMC14AT3	15.6	1	23.2	64.7	5	GEK
15	1SMC15AT3	16.7	1	24.4	61.5	5	GEM
16	1SMC16AT3	17.8	1	26	57.7	5	GEP
17	1SMC17AT3	18.9	1	27.6	53.3	5	GER
18	1SMC18AT3	20	1	29.2	51.4	5	GET
20	1SMC20AT3	22.2	1	32.4	46.3	5	GEV
22	1SMC22AT3	24.4	1	35.5	42.2	5	GEX
24	1SMC24AT3	26.7	1	38.9	38.6	5	GEZ
26	1SMC26AT3	28.9	1	42.1	35.6	5	GFE
28	1SMC28AT3	31.1	1	45.4	33	5	GFG
30	1SMC30AT3	33.3	1	48.4	31	5	GFK
33	1SMC33AT3	36.7	1	53.3	28.1	5	GFM
36	1SMC36AT3	40	1	58.1	25.8	5	GFP
40	1SMC40AT3	44.4	1	64.5	23.2	5	GFR
43	1SMC43AT3	47.8	1	69.4	21.6	5	GFT
45	1SMC45AT3	50	1	72.7	20.6	5	GFV
48	1SMC48AT3	53.3	1	77.4	19.4	5	GFY
51	1SMC51AT3	56.7	1	82.4	18.2	5	GFZ
54	1SMC54AT3	60	1	87.1	17.2	5	GGE
58	1SMC58AT3	64.4	1	93.6	16	5	GGG
60	1SMC60AT3	66.7	1	96.8	15.5	5	GGK
64	1SMC64AT3	71.1	1	103	14.6	5	GGM
70	1SMC70AT3	77.8	1	113	13.3	5	GGP
75	1SMC75AT3	83.3	1	121	12.4	5	GGR
78	1SMC78AT3	86.7	1	126	11.4	5	GGT

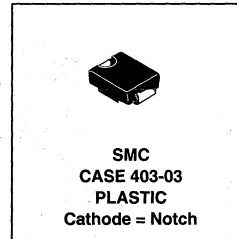

RECOMMENDED SOLDER PAD (FOOTPRINT)

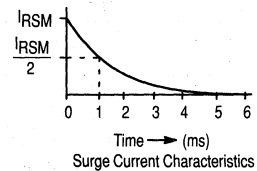
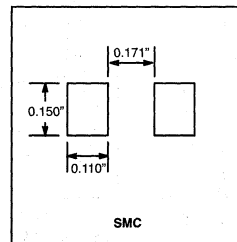

Note 1. A transient suppressor is normally selected according to the reverse "Stand Off Voltage" (V_R) which should be equal to or greater than the DC or continuous peak operating voltage level.

Note 2. T3 suffix designates tape and reel of 2500 units.

SELECTOR GUIDE

SURFACE MOUNT PACKAGES (continued) (See Section 4.1.4 for complete data)

PEAK POWER DISSIPATION — 1500 WATTS @ 1 ms SURGE (FIGURE 1) — CASE 403-03

ELECTRICAL CHARACTERISTICS (T _A = 25°C unless otherwise noted) V _F = 3.5 V Max, I _F = 100 A Pulse.								
Breakdown Voltage*		Device**	Working Peak Reverse Voltage V _{RWM} Volts	Maximum Reverse Leakage @ V _{RWM} I _R (μA)	Maximum Reverse Surge Current Figure 1 I _{RSM} (Amps)	Maximum Reverse Voltage @ I _{RSM} (Clamping Voltage) V _{RSM} (Volts)	Device Marking	
V _{BR} @ I _T Pulse Volts								
Nom	mA							
6.8	10	1.5SMC6.8AT3	5.8	1000	143	10.5	6V8A	
7.5	10	1.5SMC7.5AT3	6.4	500	132	11.3	7V5A	
8.2	10	1.5SMC8.2AT3	7.02	200	124	12.1	8V2A	
9.1	1	1.5SMC9.1AT3	7.78	50	112	13.4	9V1A	
10	1	1.5SMC10AT3	8.55	10	103	14.5	10A	
11	1	1.5SMC11AT3	9.4	5	96	15.6	11A	
12	1	1.5SMC12AT3	10.2	5	90	16.7	12A	
13	1	1.5SMC13AT3	11.1	5	82	18.2	13A	
15	1	1.5SMC15AT3	12.8	5	71	21.2	15A	
16	1	1.5SMC16AT3	13.6	5	67	22.5	16A	
18	1	1.5SMC18AT3	15.3	5	59.5	25.2	18A	
20	1	1.5SMC20AT3	17.1	5	54	27.7	20A	
22	1	1.5SMC22AT3	18.8	5	49	30.6	22A	
24	1	1.5SMC24AT3	20.5	5	45	33.2	24A	
27	1	1.5SMC27AT3	23.1	5	40	37.5	27A	
30	1	1.5SMC30AT3	25.6	5	36	41.4	30A	
33	1	1.5SMC33AT3	28.2	5	33	45.7	33A	
36	1	1.5SMC36AT3	30.8	5	30	49.9	36A	
39	1	1.5SMC39AT3	33.3	5	28	53.9	39A	
43	1	1.5SMC43AT3	36.8	5	25.3	59.3	43A	
47	1	1.5SMC47AT3	40.2	5	23.2	64.8	47A	
51	1	1.5SMC51AT3	43.6	5	21.4	70.1	51A	
56	1	1.5SMC56AT3	47.8	5	19.5	77	56A	
62	1	1.5SMC62AT3	53	5	17.7	85	62A	
68	1	1.5SMC68AT3	58.1	5	16.3	92	68A	
75	1	1.5SMC75AT3	64.1	5	14.6	103	75A	
82	1	1.5SMC82AT3	70.1	5	13.3	113	82A	
91	1	1.5SMC91AT3	77.8	5	12	125	91A	

* Breakdown voltage tolerance is ±5% for A suffix.

** T3 suffix designates tape and reel of 2500 units.

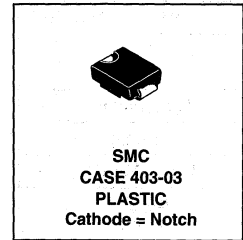

RECOMMENDED SOLDER PAD (FOOTPRINT)

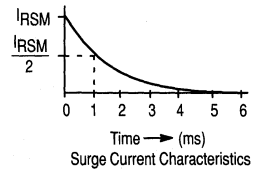
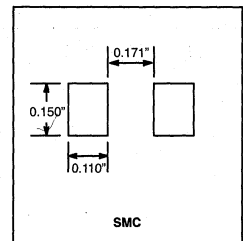

Figure 1

4

4.1

SELECTOR GUIDE

TRANSIENT VOLTAGE SUPPRESSORS (continued)

Automotive Transient Suppressors (See Section 4.1.4 for complete data)

Automotive transient suppressors are designed for protection against over-voltage conditions in the auto electrical system including the "LOAD DUMP" phenomenon that occurs when the battery open circuits while the car is running.

AUTOMOTIVE TRANSIENT SUPPRESSOR	
	CASE 194-04 MR2535L
V_{RRM} (Volts)	20
I_O (Amp)	35
$V_{(BR)}$ (Volts)	24–32
I_{RSM}^* (Amp)	110
T_C @ Rated I_O (°C)	150
T (°C)	175

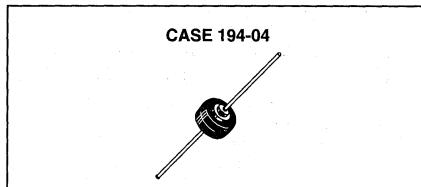

4

* Time constant = 10 ms, duty cycle \leq 1%, $T_C = 25^\circ\text{C}$.

Note: MR2535L is considered part of the rectifier product portfolio.

4.1

Section 4.1.2 Data Sheet Category Listing Transient Voltage Suppressors

Section	Data Sheets	Page	Section	Data Sheets	Page
4.1.4.1	AXIAL LEADED	4-1-24	4.1.4.2	SURFACE MOUNTED — SOT-23, SMB and SMC PACKAGES	4-1-51
4.1.4.1.1	500 Watt Peak Power	4-1-24	4.1.4.2.1	40 Watt Peak Power	4-1-51
	SA5.0 thru SA170A	4-1-25		MMBZ15VDLT1	4-1-52
4.1.4.1.2	600 Watt Peak Power	4-1-31	4.1.4.2.2	600 Watt Peak Power	4-1-55
	P6KE6.8 thru P6KE200A	4-1-32		General Data — 600 Watt	4-1-56
4.1.4.1.3	1500 Watt Peak Power	4-1-37		1SMB5.0AT3 thru	
	General Data — 1500 Watt ...	4-1-38		1SMB170AT3	4-1-59
	1N5908	4-1-42		P6SMB6.8AT3 thru	
	1N6267 thru 1N6303A,			P6SMB200AT3	4-1-60
	1.5KE6.8 thru 1.5KE250A ..	4-1-43	4.1.4.2.3	1500 Watt Peak Power	4-1-61
	1N6373 thru 1N6389,			General Data — 1500 Watt ...	4-1-62
	ICTE-5 thru ICTE-45C,			1SMC5.0AT3 thru	
	MPTE-5 thru MPTE-45C ...	4-1-46		1SMC78AT3	4-1-65
4.1.4.1.4	Automotive 110 Amp	4-1-47		1.5SMC6.8AT3 thru	
	MR2535L	4-1-48		1.5SMC91AT3	4-1-66

Section 4.1.3 Alphanumeric Part Number Listing Transient Voltage Suppressors

4

4.1

ALPHANUMERIC INDEX – TRANSIENT VOLTAGE SUPPRESSORS

DEVICE	PAGE	DEVICE	PAGE	DEVICE	PAGE
1N5908	4-1-42	1N6286A	4-1-43	1N6378	4-1-46
1N6267	4-1-43	1N6287	4-1-43	1N6379	4-1-46
1N6267A	4-1-43	1N6287A	4-1-43	1N6380	4-1-46
1N6268	4-1-43	1N6288	4-1-43	1N6381	4-1-46
1N6268A	4-1-43	1N6288A	4-1-43	1N6382	4-1-46
1N6269	4-1-43	1N6289	4-1-44	1N6383	4-1-46
1N6269A	4-1-43	1N6289A	4-1-44	1N6384	4-1-46
1N6270	4-1-43	1N6290	4-1-44	1N6385	4-1-46
1N6270A	4-1-43	1N6290A	4-1-44	1N6386	4-1-46
1N6271	4-1-43	1N6291	4-1-44	1N6387	4-1-46
1N6271A	4-1-43	1N6291A	4-1-44	1N6388	4-1-46
1N6272	4-1-43	1N6292	4-1-44	1N6389	4-1-46
1N6272A	4-1-43	1N6292A	4-1-44	1SMB5.0AT3	4-1-59
1N6273	4-1-43	1N6293	4-1-44	1SMB6.0AT3	4-1-59
1N6273A	4-1-43	1N6293A	4-1-44	1SMB6.5AT3	4-1-59
1N6274	4-1-43	1N6294	4-1-44	1SMB7.0AT3	4-1-59
1N6274A	4-1-43	1N6294A	4-1-44	1SMB7.5AT3	4-1-59
1N6275	4-1-43	1N6295	4-1-44	1SMB8.0AT3	4-1-59
1N6275A	4-1-43	1N6295A	4-1-44	1SMB8.5AT3	4-1-59
1N6276	4-1-43	1N6296	4-1-44	1SMB9.0AT3	4-1-59
1N6276A	4-1-43	1N6296A	4-1-44	1SMB10AT3	4-1-59
1N6277	4-1-43	1N6297	4-1-44	1SMB11AT3	4-1-59
1N6277A	4-1-43	1N6297A	4-1-44	1SMB12AT3	4-1-59
1N6278	4-1-43	1N6298	4-1-44	1SMB13AT3	4-1-59
1N6278A	4-1-43	1N6298A	4-1-44	1SMB14AT3	4-1-59
1N6279	4-1-43	1N6299	4-1-44	1SMB15AT3	4-1-59
1N6279A	4-1-43	1N6299A	4-1-44	1SMB16AT3	4-1-59
1N6280	4-1-43	1N6300	4-1-44	1SMB17AT3	4-1-59
1N6280A	4-1-43	1N6300A	4-1-44	1SMB18AT3	4-1-59
1N6281	4-1-43	1N6301	4-1-44	1SMB20AT3	4-1-59
1N6281A	4-1-43	1N6301A	4-1-44	1SMB22AT3	4-1-59
1N6282	4-1-43	1N6302	4-1-44	1SMB24AT3	4-1-59
1N6282A	4-1-43	1N6302A	4-1-44	1SMB26AT3	4-1-59
1N6283	4-1-43	1N6303	4-1-44	1SMB28AT3	4-1-59
1N6283A	4-1-43	1N6303A	4-1-44	1SMB30AT3	4-1-59
1N6284	4-1-43	1N6373	4-1-46	1SMB33AT3	4-1-59
1N6284A	4-1-43	1N6374	4-1-46	1SMB36AT3	4-1-59
1N6285	4-1-43	1N6375	4-1-46	1SMB40AT3	4-1-59
1N6285A	4-1-43	1N6376	4-1-46	1SMB43AT3	4-1-59
1N6286	4-1-43	1N6377	4-1-46	1SMB45AT3	4-1-59

4

4.1

ALPHANUMERIC INDEX (continued)

DEVICE	PAGE	DEVICE	PAGE	DEVICE	PAGE
1SMB48AT3	4-1-59	1SMC33AT3	4-1-65	1.5KE24A	4-1-43
1SMB51AT3	4-1-59	1SMC36AT3	4-1-65	1.5KE27	4-1-43
1SMB54AT3	4-1-59	1SMC40AT3	4-1-65	1.5KE27A	4-1-43
1SMB58AT3	4-1-59	1SMC43AT3	4-1-65	1.5KE30	4-1-43
1SMB60AT3	4-1-59	1SMC45AT3	4-1-65	1.5KE30A	4-1-43
1SMB64AT3	4-1-59	1SMC48AT3	4-1-65	1.5KE33	4-1-43
1SMB70AT3	4-1-59	1SMC51AT3	4-1-65	1.5KE33A	4-1-43
1SMB75AT3	4-1-59	1SMC54AT3	4-1-65	1.5KE36	4-1-43
1SMB78AT3	4-1-59	1SMC58AT3	4-1-65	1.5KE36A	4-1-43
1SMB85AT3	4-1-59	1SMC60AT3	4-1-65	1.5KE39	4-1-43
1SMB90AT3	4-1-59	1SMC64AT3	4-1-65	1.5KE39A	4-1-43
1SMB100AT3	4-1-59	1SMC70AT3	4-1-65	1.5KE43	4-1-43
1SMB110AT3	4-1-59	1SMC75AT3	4-1-65	1.5KE43A	4-1-43
1SMB120AT3	4-1-59	1SMC78AT3	4-1-65	1.5KE47	4-1-43
1SMB130AT3	4-1-59	1.5KE6.8	4-1-43	1.5KE47A	4-1-43
1SMB150AT3	4-1-59	1.5KE6.8A	4-1-43	1.5KE51	4-1-43
1SMB160AT3	4-1-59	1.5KE7.5	4-1-43	1.5KE51A	4-1-43
1SMB170AT3	4-1-59	1.5KE7.5A	4-1-43	1.5KE56	4-1-44
1SMC5.0AT3	4-1-65	1.5KE8.2	4-1-43	1.5KE56A	4-1-44
1SMC6.0AT3	4-1-65	1.5KE8.2A	4-1-43	1.5KE62	4-1-44
1SMC6.5AT3	4-1-65	1.5KE9.1	4-1-43	1.5KE62A	4-1-44
1SMC7.0AT3	4-1-65	1.5KE9.1A	4-1-43	1.5KE68	4-1-44
1SMC7.5AT3	4-1-65	1.5KE10	4-1-43	1.5KE68A	4-1-44
1SMC8.0AT3	4-1-65	1.5KE10A	4-1-43	1.5KE75	4-1-44
1SMC8.5AT3	4-1-65	1.5KE11	4-1-43	1.5KE75A	4-1-44
1SMC9.0AT3	4-1-65	1.5KE11A	4-1-43	1.5KE82	4-1-44
1SMC10AT3	4-1-65	1.5KE12	4-1-43	1.5KE82A	4-1-44
1SMC11AT3	4-1-65	1.5KE12A	4-1-43	1.5KE91	4-1-44
1SMC12AT3	4-1-65	1.5KE13	4-1-43	1.5KE91A	4-1-44
1SMC13AT3	4-1-65	1.5KE13A	4-1-43	1.5KE100	4-1-44
1SMC14AT3	4-1-65	1.5KE15	4-1-43	1.5KE100A	4-1-44
1SMC15AT3	4-1-65	1.5KE15A	4-1-43	1.5KE110	4-1-44
1SMC16AT3	4-1-65	1.5KE16	4-1-43	1.5KE110A	4-1-44
1SMC17AT3	4-1-65	1.5KE16A	4-1-43	1.5KE120	4-1-44
1SMC18AT3	4-1-65	1.5KE18	4-1-43	1.5KE120A	4-1-44
1SMC20AT3	4-1-65	1.5KE18A	4-1-43	1.5KE130	4-1-44
1SMC22AT3	4-1-65	1.5KE20	4-1-43	1.5KE130A	4-1-44
1SMC24AT3	4-1-65	1.5KE20A	4-1-43	1.5KE150	4-1-44
1SMC26AT3	4-1-65	1.5KE22	4-1-43	1.5KE150A	4-1-44
1SMC28AT3	4-1-65	1.5KE22A	4-1-43	1.5KE160	4-1-44
1SMC30AT3	4-1-65	1.5KE24	4-1-43	1.5KE160A	4-1-44

ALPHANUMERIC INDEX (continued)

DEVICE	PAGE	DEVICE	PAGE	DEVICE	PAGE
1.5KE170	4-1-44	ICTE-10	4-1-46	P6KE10	4-1-33
1.5KE170A	4-1-44	ICTE-10C	4-1-46	P6KE10A	4-1-33
1.5KE180	4-1-44	ICTE-12	4-1-46	P6KE11	4-1-33
1.5KE180A	4-1-44	ICTE-12C	4-1-46	P6KE11A	4-1-33
1.5KE200	4-1-44	ICTE-15	4-1-46	P6KE12	4-1-33
1.5KE200A	4-1-44	ICTE-15C	4-1-46	P6KE12A	4-1-33
1.5KE220	4-1-44	ICTE-18	4-1-46	P6KE13	4-1-33
1.5KE220A	4-1-44	ICTE-18C	4-1-46	P6KE13A	4-1-33
1.5KE250	4-1-44	ICTE-22	4-1-46	P6KE15	4-1-33
1.5KE250A	4-1-44	ICTE-22C	4-1-46	P6KE15A	4-1-33
1.5SMC6.8AT3	4-1-66	ICTE-36	4-1-46	P6KE16	4-1-33
1.5SMC7.5AT3	4-1-66	ICTE-36C	4-1-46	P6KE16A	4-1-33
1.5SMC8.2AT3	4-1-66	ICTE-45	4-1-46	P6KE18	4-1-33
1.5SMC9.1AT3	4-1-66	ICTE-45C	4-1-46	P6KE18A	4-1-33
1.5SMC10AT3	4-1-66	MMBZ15VDLT1	4-1-52	P6KE20	4-1-33
1.5SMC11AT3	4-1-66	MPTE-5	4-1-46	P6KE20A	4-1-33
1.5SMC12AT3	4-1-66	MPTE-8	4-1-46	P6KE22	4-1-33
1.5SMC13AT3	4-1-66	MPTE-8C	4-1-46	P6KE22A	4-1-33
1.5SMC15AT3	4-1-66	MPTE-10	4-1-46	P6KE24	4-1-33
1.5SMC16AT3	4-1-66	MPTE-10C	4-1-46	P6KE24A	4-1-33
1.5SMC18AT3	4-1-66	MPTE-12	4-1-46	P6KE27	4-1-33
1.5SMC20AT3	4-1-66	MPTE-12C	4-1-46	P6KE27A	4-1-33
1.5SMC22AT3	4-1-66	MPTE-15	4-1-46	P6KE30	4-1-33
1.5SMC24AT3	4-1-66	MPTE-15C	4-1-46	P6KE30A	4-1-33
1.5SMC27AT3	4-1-66	MPTE-18	4-1-46	P6KE33	4-1-33
1.5SMC30AT3	4-1-66	MPTE-18C	4-1-46	P6KE33A	4-1-33
1.5SMC33AT3	4-1-66	MPTE-22	4-1-46	P6KE36	4-1-33
1.5SMC36AT3	4-1-66	MPTE-22C	4-1-46	P6KE36A	4-1-33
1.5SMC39AT3	4-1-66	MPTE-36	4-1-46	P6KE39	4-1-33
1.5SMC43AT3	4-1-66	MPTE-36C	4-1-46	P6KE39A	4-1-33
1.5SMC47AT3	4-1-66	MPTE-45	4-1-46	P6KE43	4-1-33
1.5SMC51AT3	4-1-66	MPTE-45C	4-1-46	P6KE43A	4-1-33
1.5SMC56AT3	4-1-66	MR2535L	4-1-48	P6KE47	4-1-33
1.5SMC62AT3	4-1-66	P6KE6.8	4-1-33	P6KE47A	4-1-33
1.5SMC68AT3	4-1-66	P6KE6.8A	4-1-33	P6KE51	4-1-33
1.5SMC75AT3	4-1-66	P6KE7.5	4-1-33	P6KE51A	4-1-33
1.5SMC82AT3	4-1-66	P6KE7.5A	4-1-33	P6KE56A	4-1-33
1.5SMC91AT3	4-1-66	P6KE8.2	4-1-33	P6KE62	4-1-33
ICTE-5	4-1-46	P6KE8.2A	4-1-33	P6KE62A	4-1-33
ICTE-8	4-1-46	P6KE9.1	4-1-33	P6KE68	4-1-34
ICTE-8C	4-1-46	P6KE9.1A	4-1-33	P6KE68A	4-1-34

4

4.1

ALPHANUMERIC INDEX (continued)

DEVICE	PAGE	DEVICE	PAGE	DEVICE	PAGE
P6KE75	4-1-34	P6SMB36AT3	4-1-60	SA12A	4-1-26
P6KE75A	4-1-34	P6SMB39AT3	4-1-60	SA13	4-1-26
P6KE82	4-1-34	P6SMB43AT3	4-1-60	SA13A	4-1-26
P6KE82A	4-1-34	P6SMB47AT3	4-1-60	SA14	4-1-26
P6KE91	4-1-34	P6SMB51AT3	4-1-60	SA14A	4-1-26
P6KE91A	4-1-34	P6SMB56AT3	4-1-60	SA15	4-1-26
P6KE100	4-1-34	P6SMB62AT3	4-1-60	SA15A	4-1-26
P6KE100A	4-1-34	P6SMB68AT3	4-1-60	SA16	4-1-26
P6KE110	4-1-34	P6SMB75AT3	4-1-60	SA16A	4-1-26
P6KE110A	4-1-34	P6SMB82AT3	4-1-60	SA17	4-1-26
P6KE120	4-1-34	P6SMB91AT3	4-1-60	SA17A	4-1-26
P6KE120A	4-1-34	P6SMB100AT3	4-1-60	SA18	4-1-26
P6KE130	4-1-34	P6SMB110AT3	4-1-60	SA18A	4-1-26
P6KE130A	4-1-34	P6SMB120AT3	4-1-60	SA20	4-1-26
P6KE150	4-1-34	P6SMB130AT3	4-1-60	SA20A	4-1-26
P6KE150A	4-1-34	P6SMB150AT3	4-1-60	SA22	4-1-26
P6KE160	4-1-34	P6SMB160AT3	4-1-60	SA22A	4-1-26
P6KE160A	4-1-34	P6SMB170AT3	4-1-60	SA24	4-1-26
P6KE170	4-1-34	P6SMB180AT3	4-1-60	SA24A	4-1-26
P6KE170A	4-1-34	P6SMB200AT3	4-1-60	SA26	4-1-26
P6KE180	4-1-34	SA5.0	4-1-26	SA26A	4-1-26
P6KE180A	4-1-34	SA5.0A	4-1-26	SA28	4-1-26
P6KE200	4-1-34	SA6.0	4-1-26	SA28A	4-1-26
P6KE200A	4-1-34	SA6.0A	4-1-26	SA30	4-1-26
P6SMB6.8AT3	4-1-60	SA6.5	4-1-26	SA30A	4-1-26
P6SMB7.5AT3	4-1-60	SA6.5A	4-1-26	SA33	4-1-26
P6SMB8.2AT3	4-1-60	SA7.0	4-1-26	SA33A	4-1-26
P6SMB9.1AT3	4-1-60	SA7.0A	4-1-26	SA36	4-1-27
P6SMB10AT3	4-1-60	SA7.5	4-1-26	SA36A	4-1-27
P6SMB11AT3	4-1-60	SA7.5A	4-1-26	SA40	4-1-27
P6SMB12AT3	4-1-60	SA8.0	4-1-26	SA40A	4-1-27
P6SMB13AT3	4-1-60	SA8.0A	4-1-26	SA43	4-1-27
P6SMB15AT3	4-1-60	SA8.5	4-1-26	SA43A	4-1-27
P6SMB16AT3	4-1-60	SA8.5A	4-1-26	SA45	4-1-27
P6SMB18AT3	4-1-60	SA9.0	4-1-26	SA45A	4-1-27
P6SMB20AT3	4-1-60	SA9.0A	4-1-26	SA48	4-1-27
P6SMB22AT3	4-1-60	SA10	4-1-26	SA48A	4-1-27
P6SMB24AT3	4-1-60	SA10A	4-1-26	SA51	4-1-27
P6SMB27AT3	4-1-60	SA11	4-1-26	SA51A	4-1-27
P6SMB30AT3	4-1-60	SA11A	4-1-26	SA54	4-1-27
P6SMB33AT3	4-1-60	SA12	4-1-26	SA54A	4-1-27

ALPHANUMERIC INDEX (continued)

DEVICE	PAGE
SA58	4-1-27
SA58A	4-1-27
SA60	4-1-27
SA60A	4-1-27
SA64	4-1-27
SA64A	4-1-27
SA70	4-1-27
SA70A	4-1-27
SA75	4-1-27
SA75A	4-1-27

DEVICE	PAGE
SA78	4-1-27
SA78A	4-1-27
SA85	4-1-27
SA85A	4-1-27
SA90	4-1-27
SA90A	4-1-27
SA100	4-1-27
SA100A	4-1-27
SA110	4-1-27
SA110A	4-1-27

DEVICE	PAGE
SA120	4-1-27
SA120A	4-1-27
SA130	4-1-27
SA130A	4-1-27
SA150	4-1-27
SA150A	4-1-27
SA160	4-1-27
SA160A	4-1-27
SA170	4-1-27
SA170A	4-1-27

Section 4.1.4 Data Sheets

Transient Voltage Suppressors

Section 4.1.4.1 Axial Leaded

4

SECTION 4.1.4.1.1 500 WATT PEAK POWER

DATA SHEETS

Devices	Page No.
SA5.0 thru SA170A	4-1-25

MULTIPLE PACKAGE QUANTITY (MPQ) REQUIREMENTS

Package Option	Type No. Suffix	MPQ (Units)
Tape and Reel	RL	5K

4.1

Zener Transient Voltage Suppressors Unidirectional and Bidirectional

The SA5.0 series is designed to protect voltage sensitive components from high voltage, high energy transients. They have excellent clamping capability, high surge capability, low zener impedance and fast response time. The SA5.0 series is supplied in Motorola's exclusive, cost-effective, highly reliable Surmetic axial leaded package and is ideally-suited for use in communication systems, numerical controls, process controls, medical equipment, business machines, power supplies and many other industrial/consumer applications.

Specification Features:

- Stand-off Zener Voltage Range — 5 to 170 V
- Peak Power — 500 Watts @ 1 ms
- Maximum Clamp Voltage @ Peak Pulse Current
- Low Leakage < 1 μ A Above 8.5 Volts
- Maximum Temperature Coefficient Specified

Mechanical Characteristics:

CASE: Void-free, transfer-molded, thermosetting plastic

FINISH: All external surfaces are corrosion resistant and leads are readily solderable

POLARITY: Cathode indicated by polarity band. When operated in zener mode, will be positive with respect to anode

MOUNTING POSITION: Any

**SA5.0
 thru
 SA170A**

**MOSORB
 ZENER OVERVOLTAGE
 TRANSIENT
 SUPPRESSORS
 5-170 VOLT
 500 WATT PEAK POWER
 3 WATT STEADY STATE**

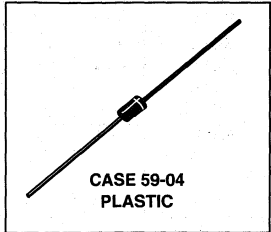

4

4.1

MAXIMUM RATINGS			
Rating	Symbol	Value	Unit
Peak Power Dissipation (1) @ $T_L \leq 25^\circ\text{C}$	P_{PK}	500	Watts
Steady State Power Dissipation @ $T_L \leq 75^\circ\text{C}$, Lead Length = 3/8" Derated above $T_L = 75^\circ\text{C}$	P_D	3	Watts
		30	mW/ $^\circ\text{C}$
Forward Surge Current (2) @ $T_A = 25^\circ\text{C}$	I_{FSM}	70	Amps
Operating and Storage Temperature Range	T_J, T_{stg}	- 55 to +175	$^\circ\text{C}$

Lead Temperature not less than 1/16" from the case for 10 seconds: 230 $^\circ\text{C}$

NOTES: 1. Nonrepetitive current pulse per Figure 4 and derated above $T_A = 25^\circ\text{C}$ per Figure 2.

2. 1/2 sine wave (or equivalent square wave), PW = 8.3 ms, duty cycle = 4 pulses per minute maximum.

SA5.0 thru SA170A

ELECTRICAL CHARACTERISTICS ($T_A = 25^\circ\text{C}$ unless otherwise noted) $V_F = 3.5\text{ V Max}$, $I_F^* = 35\text{ A}$ (except bidirectional devices).

Device	Breakdown Voltage		@ I_T (mA)	Working Peak Reverse Voltage V_{RWM}^{**} (Volts)	Maximum Reverse Leakage @ V_{RWM} I_R (μA)	Maximum Reverse Surge Current I_{RSM}^\dagger (Amps)	Maximum Reverse Voltage @ I_{RSM} (Clamping Voltage) V_{RSM} (Volts)	Maximum Voltage Temperature Variation of V_{BR} mV/ $^\circ\text{C}$
	$V_{BR}^{\dagger\dagger}$ (Volts)							
	Min	Max						
SA5.0	6.4	7.3	10	5	600	52	9.6	5
⇒ SA5.0A	6.4	7	10	5	600	54.3	9.2	5
SA6.0	6.67	8.15	10	6	600	43.9	11.4	5
⇒ SA6.0A	6.67	7.37	10	6	600	48.5	10.3	5
SA6.5	7.22	8.82	10	6.5	400	40.7	12.3	5
SA6.5A	7.22	7.98	10	6.5	400	44.7	11.2	5
SA7.0	7.78	9.51	10	7	150	37.8	13.3	6
SA7.0A	7.78	8.6	10	7	150	41.7	12	6
SA7.5	8.33	10.2	1	7.5	50	35	14.3	7
SA7.5A	8.33	9.21	1	7.5	50	38.8	12.9	7
SA8.0	8.89	10.9	1	8	25	33.3	15	7
SA8.0A	8.89	9.83	1	8	25	36.7	13.6	7
SA8.5	9.44	11.5	1	8.5	5	31.4	15.9	8
SA8.5A	9.44	10.4	1	8.5	5	34.7	14.4	8
SA9.0	10	12.2	1	9	1	29.5	16.9	9
SA9.0A	10	11.1	1	9	1	32.5	15.4	9
SA10	11.1	13.6	1	10	1	26.6	18.8	10
SA10A	11.1	12.3	1	10	1	29.4	17	10
SA11	12.2	14.9	1	11	1	24.9	20.1	11
SA11A	12.2	13.5	1	11	1	27.4	18.2	11
SA12	13.3	16.3	1	12	1	22.7	22	12
⇒ SA12A	13.3	14.7	1	12	1	25.1	19.9	12
SA13	14.4	17.6	1	13	1	21	23.8	13
⇒ SA13A	14.4	15.9	1	13	1	23.2	21.5	13
SA14	15.6	19.1	1	14	1	19.4	25.8	14
SA14A	15.6	17.2	1	14	1	21.5	23.2	14
SA15	16.7	20.4	1	15	1	18.8	26.9	16
⇒ SA15A	16.7	18.5	1	15	1	20.6	24.4	16
SA16	17.8	21.8	1	16	1	17.6	28.8	19
SA16A	17.8	19.7	1	16	1	19.2	26	17
SA17	18.9	23.1	1	17	1	16.4	30.5	20
SA17A	18.9	20.9	1	17	1	18.1	27.6	19
SA18	20	24.4	1	18	1	15.5	32.2	21
SA18A	20	22.1	1	18	1	17.2	29.2	20
SA20	22.2	27.1	1	20	1	13.9	35.8	25
SA20A	22.2	24.5	1	20	1	15.4	32.4	23
SA22	24.4	29.8	1	22	1	12.7	39.4	28
SA22A	24.4	26.9	1	22	1	14.1	35.5	25
SA24	26.7	32.6	1	24	1	11.6	43	31
SA24A	26.7	29.5	1	24	1	12.8	38.9	28
SA26	28.9	35.3	1	26	1	10.7	46.6	31
SA26A	28.9	31.9	1	26	1	11.9	42.1	30
SA28	31.1	38	1	28	1	9.9	50	35
SA28A	31.1	34.4	1	28	1	11	45.4	31
SA30	33.3	40.7	1	30	1	9.3	53.5	39
SA30A	33.3	36.8	1	30	1	10.3	48.4	36
SA33	36.7	44.9	1	33	1	8.5	59	42
SA33A	36.7	40.6	1	33	1	9.4	53.3	39

(continued)

⇒ Preferred part

FOR BIDIRECTIONAL APPLICATIONS

— USE C or CA SUFFIX

Preferred Bidirectional Devices —

SA6.5CA	SA13CA	SA18CA
SA12CA	SA15CA	SA24CA

SA5.0 thru SA170A

ELECTRICAL CHARACTERISTICS — continued ($T_A = 25^\circ\text{C}$ unless otherwise noted) $V_F = 3.5\text{ V Max}$, $I_F^* = 35\text{ A}$ (except bidirectional devices).								
Device	Breakdown Voltage			Working Peak Reverse Voltage V_{RWM}^{**} (Volts)	Maximum Reverse Leakage @ V_{RWM} I_R (μA)	Maximum Reverse Surge Current I_{RSM}^\dagger (Amps)	Maximum Reverse Voltage @ I_{RSM} (Clamping Voltage) V_{RSM} (Volts)	Maximum Voltage Temperature Variation of V_{BR} $\text{mV}/^\circ\text{C}$
	$V_{BR}^{\dagger\dagger}$ (Volts)		@ I_T (mA)					
	Min	Max						
SA36	40	48.9	1	36	1	7.8	64.3	46
SA36A	40	44.2	1	36	1	8.6	58.1	41
SA40	44.4	54.3	1	40	1	7	71.4	51
SA40A	44.4	49.1	1	40	1	7.8	64.5	46
SA43	47.8	58.4	1	43	1	6.5	76.7	55
SA43A	47.8	52.8	1	43	1	7.2	69.4	50
SA45	50	61.1	1	45	1	6.2	80.3	58
SA45A	50	55.3	1	45	1	6.9	72.7	52
SA48	53.3	65.1	1	48	1	5.8	85.5	63
SA48A	53.3	58.9	1	48	1	6.5	77.4	56
SA51	56.7	69.3	1	51	1	5.5	91.1	66
SA51A	56.7	62.7	1	51	1	6.1	82.4	61
SA54	60	73.3	1	54	1	5.2	96.3	71
SA54A	60	66.3	1	54	1	5.7	87.1	65
SA58	64.4	78.7	1	58	1	4.9	103	78
SA58A	64.4	71.2	1	58	1	5.3	93.6	70
SA60	66.7	81.5	1	60	1	4.7	107	80
SA60A	66.7	73.7	1	60	1	5.2	96.8	71
SA64	71.1	86.9	1	64	1	4.4	114	86
SA64A	71.1	78.6	1	64	1	4.9	103	76
SA70	77.8	95.1	1	70	1	4	125	94
SA70A	77.8	86	1	70	1	4.4	113	85
SA75	83.3	102	1	75	1	3.7	134	101
SA75A	83.3	92.1	1	75	1	4.1	121	91
SA78	86.7	106	1	78	1	3.6	139	105
SA78A	86.7	95.8	1	78	1	4	126	95
SA85	94.4	115	1	85	1	3.3	151	114
SA85A	94.4	104	1	85	1	3.6	137	103
SA90	100	122	1	90	1	3.1	160	121
SA90A	100	111	1	90	1	3.4	146	110
SA100	111	136	1	100	1	2.8	179	135
SA100A	111	123	1	100	1	3.1	162	123
SA110	122	149	1	110	1	2.6	196	148
SA110A	122	135	1	110	1	2.8	177	133
SA120	133	163	1	120	1	2.3	214	162
SA120A	133	147	1	120	1	2.5	193	146
SA130	144	176	1	130	1	2.2	231	175
SA130A	144	159	1	130	1	2.4	209	158
SA150	167	204	1	150	1	1.9	268	203
SA150A	167	185	1	150	1	2.1	243	184
SA160	178	218	1	160	1	1.7	287	217
SA160A	178	197	1	160	1	1.9	259	196
SA170	189	231	1	170	1	1.6	304	230
SA170A	189	209	1	170	1	1.8	275	208

* 1/2 sine wave (or equivalent square wave), PW = 8.3 ms, duty cycle = 4 pulses per minute maximum.

** MOSORB transient suppressors are normally selected according to the maximum reverse stand-off voltage (V_{RWM}), which should be equal to or greater than the dc or continuous peak operating voltage level.

† Surge current waveform per Figure 4 and derate per Figure 2.

†† V_{BR} measured at pulse test current I_T at an ambient temperature of 25°C .

FOR BIDIRECTIONAL APPLICATIONS — USE C or CA SUFFIX

SA5.0 thru SA170A

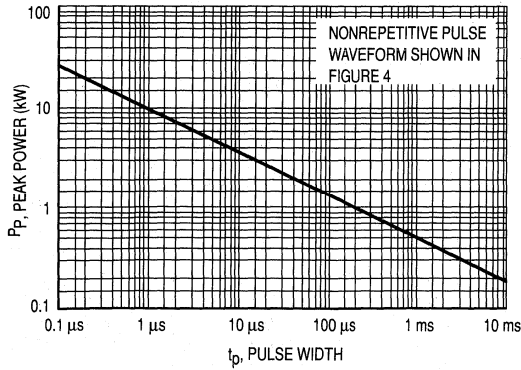

Figure 1. Pulse Rating Curve

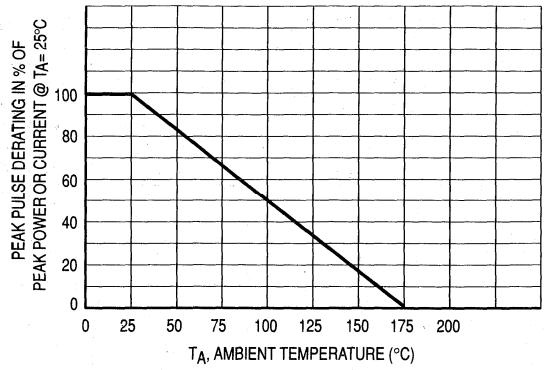

Figure 2. Pulse Derating Curve

4

4.1

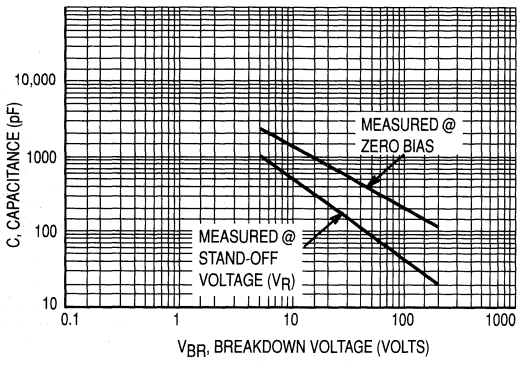

Figure 3. Capacitance versus Breakdown Voltage

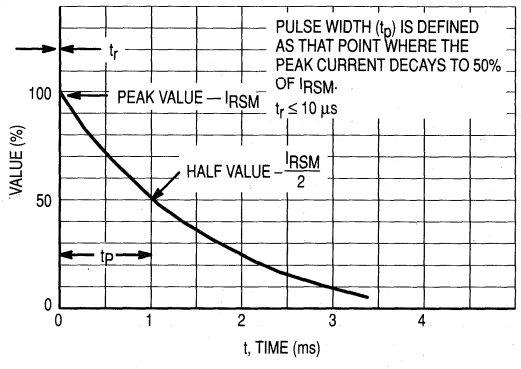

Figure 4. Pulse Waveform

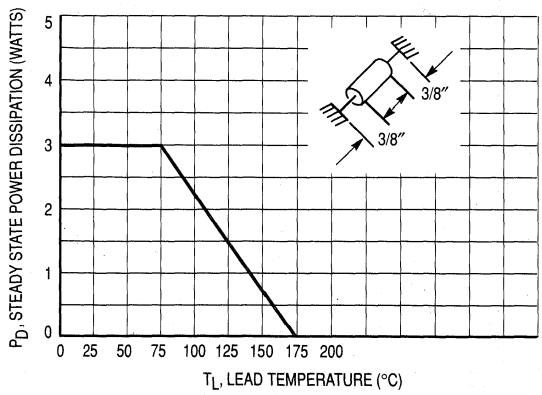

Figure 5. Steady State Power Derating

APPLICATION NOTES

RESPONSE TIME

In most applications, the transient suppressor device is placed in parallel with the equipment or component to be protected. In this situation, there is a time delay associated with the capacitance of the device and an overshoot condition associated with the inductance of the device and the inductance of the connection method. The capacitance effect is of minor importance in the parallel protection scheme because it only produces a time delay in the transition from the operating voltage to the clamp voltage as shown in Figure 6.

The inductive effects in the device are due to actual turn-on time (time required for the device to go from zero current to full current) and lead inductance. This inductive effect produces an overshoot in the voltage across the equipment or component being protected as shown in Figure 7. Minimizing this overshoot is very important in the application, since the main purpose for adding a transient suppressor is to clamp voltage spikes. The SA5.0 series has very good response time, typically < 1 ns and negligible inductance. However, external inductive effects could produce unacceptable overshoot. Proper circuit layout, minimum lead lengths and placing the suppressor device as close as possible to the equipment or components to be protected will minimize this overshoot.

Some input impedance represented by Z_{in} is essential to prevent overstress of the protection device. This impedance should be as high as possible, without restricting the circuit operation.

DUTY CYCLE DERATING

The data of Figure 1 applies for non-repetitive conditions and at a lead temperature of 25°C. If the duty cycle increases, the peak power must be reduced as indicated by the curves of Figure 8. Average power must be derated as the lead or ambient temperature rises above 25°C. The average power derating curve normally given on data sheets may be normalized and used for this purpose.

At first glance the derating curves of Figure 8 appear to be in error as the 10 ms pulse has a higher derating factor than the 10 μ s pulse. However, when the derating factor for a given pulse of Figure 8 is multiplied by the peak power value of Figure 1 for the same pulse, the results follow the expected trend.

TYPICAL PROTECTION CIRCUIT

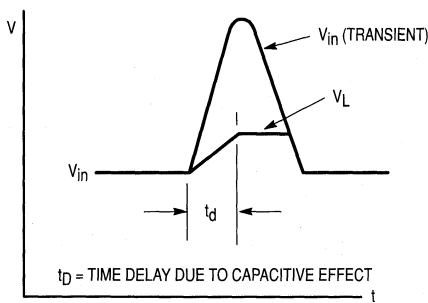
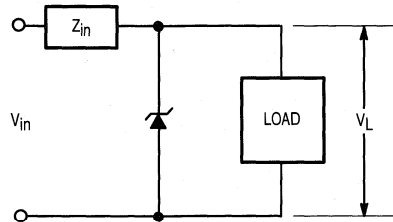

Figure 6.

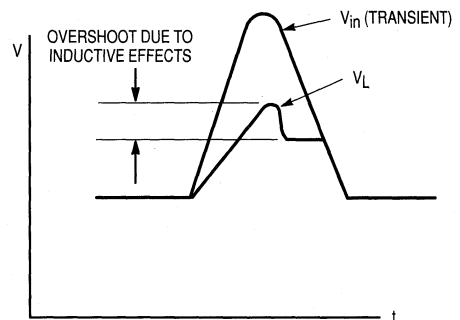

Figure 7.

SA5.0 thru SA170A

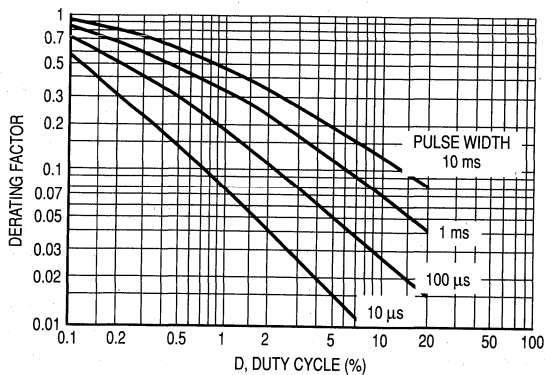

Figure 8. Typical Derating Factor for Duty Cycle

4

4.1

SECTION 4.1.4 DATA SHEETS
TRANSIENT VOLTAGE SUPPRESSORS — continued

Section 4.1.4.1 Axial Leaded — continued

SECTION 4.1.4.1.2 600 WATT PEAK POWER

DATA SHEETS

Devices	Page No.
P6KE6.8 thru P6KE200A	4-1-32

MULTIPLE PACKAGE QUANTITY (MPQ)
REQUIREMENTS

Package Option	Type No. Suffix	MPQ (Units)
Tape and Reel	RL	4K
Tape and Ammo	TA	2K

4

4.1

Zener Transient Voltage Suppressors Unidirectional and Bidirectional

**P6KE6.8, A
 thru
 P6KE200, A**

The P6KE6.8 series is designed to protect voltage sensitive components from high voltage, high energy transients. They have excellent clamping capability, high surge capability, low zener impedance and fast response time. The P6KE6.8 series is supplied in Motorola's exclusive, cost-effective, highly reliable Surmetic axial leaded package and is ideally-suited for use in communication systems, numerical controls, process controls, medical equipment, business machines, power supplies and many other industrial/consumer applications.

**ZENER OVERVOLTAGE
 TRANSIENT
 SUPPRESSORS
 6.8-200 VOLT
 600 WATT PEAK POWER
 5 WATTS STEADY STATE**

Specification Features:

- Standard Zener Voltage Range — 6.8 to 200 V
- Peak Power — 600 Watts @ 1 ms
- Maximum Clamp Voltage @ Peak Pulse Current
- Low Leakage < 5 μ A Above 10 V
- Maximum Temperature Coefficient Specified
- UL Recognition

Mechanical Characteristics:

CASE: Void-free, transfer-molded, thermosetting plastic

FINISH: All external surfaces are corrosion resistant and leads are readily solderable

POLARITY: Cathode indicated by polarity band. When operated in zener mode, will be positive with respect to anode

MOUNTING POSITION: Any

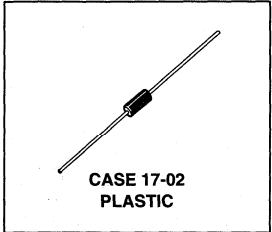

4

4.1

MAXIMUM RATINGS			
Rating	Symbol	Value	Unit
Peak Power Dissipation (1) @ $T_L \leq 25^\circ\text{C}$	P_{PK}	600	Watts
Steady State Power Dissipation @ $T_L \leq 75^\circ\text{C}$, Lead Length = 3/8" Derated above $T_L = 75^\circ\text{C}$	P_D	5	Watts
		50	mW/ $^\circ\text{C}$
Forward Surge Current (2) @ $T_A = 25^\circ\text{C}$	I_{FSM}	100	Amps
Operating and Storage Temperature Range	T_J, T_{stg}	- 65 to +175	$^\circ\text{C}$

Lead Temperature not less than 1/16" from the case for 10 seconds: 230°C

NOTES: 1. Nonrepetitive current pulse per Figure 4 and derated above $T_A = 25^\circ\text{C}$ per Figure 2.
 2. 1/2 sine wave (or equivalent square wave), PW = 8.3 ms, duty cycle = 4 pulses per minute maximum.

P6KE6.8, A thru P6KE200, A

ELECTRICAL CHARACTERISTICS (T _A = 25°C unless otherwise noted) V _F = 3.5 V Max, I _F ** = 50 A (except bidirectional devices).									
Device	Breakdown Voltage*				Working Peak Reverse Voltage V _{RWM} (Volts)	Maximum Reverse Leakage @ V _{RWM} I _R (μA)	Maximum Reverse Surge Current I _{RSM} [†] (Amps)	Maximum Reverse Voltage @ I _{RSM} (Clamping Voltage) V _{RSM} (Volts)	Maximum Temperature Coefficient of V _{BR} (%/°C)
	V _{BR} (Volts)			@ I _T					
	Min	Nom	Max						
P6KE6.8	6.12	6.8	7.48	10	5.5	1000	56	10.8	0.057
⇒ P6KE6.8A	6.45	6.8	7.14	10	5.8	1000	57	10.5	0.057
P6KE7.5	6.75	7.5	8.25	10	6.05	500	51	11.7	0.061
P6KE7.5A	7.13	7.5	7.88	10	6.4	500	53	11.3	0.061
P6KE8.2	7.38	8.2	9.02	10	6.63	200	48	12.5	0.065
P6KE8.2A	7.79	8.2	8.61	10	7.02	200	50	12.1	0.065
P6KE9.1	8.19	9.1	10	1	7.37	50	44	13.8	0.068
P6KE9.1A	8.65	9.1	9.55	1	7.78	50	45	13.4	0.068
P6KE10	9	10	11	1	8.1	10	40	15	0.073
P6KE10A	9.5	10	10.5	1	8.55	10	41	14.5	0.073
P6KE11	9.9	11	12.1	1	8.92	5	37	16.2	0.075
P6KE11A	10.5	11	11.6	1	9.4	5	38	15.6	0.075
P6KE12	10.8	12	13.2	1	9.72	5	35	17.3	0.078
P6KE12A	11.4	12	12.6	1	10.2	5	36	16.7	0.078
P6KE13	11.7	13	14.3	1	10.5	5	32	19	0.081
⇒ P6KE13A	12.4	13	13.7	1	11.1	5	33	18.2	0.081
P6KE15	13.5	15	16.5	1	12.1	5	27	22	0.084
⇒ P6KE15A	14.3	15	15.8	1	12.8	5	28	21.2	0.084
P6KE16	14.4	16	17.6	1	12.9	5	26	23.5	0.086
P6KE16A	15.2	16	16.8	1	13.6	5	27	22.5	0.086
P6KE18	16.2	18	19.8	1	14.5	5	23	26.5	0.088
P6KE18A	17.1	18	18.9	1	15.3	5	24	25.2	0.088
P6KE20	18	20	22	1	16.2	5	21	29.1	0.09
P6KE20A	19	20	21	1	17.1	5	22	27.7	0.09
P6KE22	19.8	22	24.2	1	17.8	5	19	31.9	0.092
P6KE22A	20.9	22	23.1	1	18.8	5	20	30.6	0.092
P6KE24	21.6	24	26.4	1	19.4	5	17	34.7	0.094
P6KE24A	22.8	24	25.2	1	20.5	5	18	33.2	0.094
P6KE27	24.3	27	29.7	1	21.8	5	15	39.1	0.096
⇒ P6KE27A	25.7	27	28.4	1	23.1	5	16	37.5	0.096
P6KE30	27	30	33	1	24.3	5	14	43.5	0.097
P6KE30A	28.5	30	31.5	1	25.6	5	14.4	41.4	0.097
P6KE33	29.7	33	36.3	1	26.8	5	12.6	47.7	0.098
⇒ P6KE33A	31.4	33	34.7	1	28.2	5	13.2	45.7	0.098
P6KE36	32.4	36	39.6	1	29.1	5	11.6	52	0.099
⇒ P6KE36A	34.2	36	37.8	1	30.8	5	12	49.9	0.099
P6KE39	35.1	39	42.9	1	31.6	5	10.6	56.4	0.1
P6KE39A	37.1	39	41	1	33.3	5	11.2	53.9	0.1
P6KE43	38.7	43	47.3	1	34.8	5	9.6	61.9	0.101
P6KE43A	40.9	43	45.2	1	36.8	5	10.1	59.3	0.101
P6KE47	42.3	47	51.7	1	38.1	5	8.9	67.8	0.101
P6KE47A	44.7	47	49.4	1	40.2	5	9.3	64.8	0.101
P6KE51	45.9	51	56.1	1	41.3	5	8.2	73.5	0.102
P6KE51A	48.5	51	53.6	1	43.6	5	8.6	70.1	0.102
P6KE56	50.4	56	61.6	1	45.4	5	7.4	80.5	0.103
P6KE56A	53.2	56	58.8	1	47.8	5	7.8	77	0.103
P6KE62	55.8	62	68.2	1	50.2	5	6.8	89	0.104
⇒ P6KE62A	58.9	62	65.1	1	53	5	7.1	85	0.104

(continued)

⇒ Preferred part

FOR BIDIRECTIONAL APPLICATIONS —
USE C or CA SUFFIX

Preferred Bidirectional Devices —

P6KE7.5CA P6KE11CA P6KE20CA
P6KE22CA P6KE27CA P6KE30CA

4

4.1

P6KE6.8, A thru P6KE200, A

ELECTRICAL CHARACTERISTICS — continued ($T_A = 25^\circ\text{C}$ unless otherwise noted) $V_F = 3.5\text{ V Max}$, $I_F^{**} = 50\text{ A}$
(except bidirectional devices).

Device	Breakdown Voltage*				Working Peak Reverse Voltage V_{RWM} (Volts)	Maximum Reverse Leakage @ V_{RWM} I_R (μA)	Maximum Reverse Surge Current I_{RSM}^\dagger (Amps)	Maximum Reverse Voltage @ I_{RSM} (Clamping Voltage) V_{RSM} (Volts)	Maximum Temperature Coefficient of V_{BR} (%/ $^\circ\text{C}$)
	V_{BR} (Volts)			@ I_T (mA)					
	Min	Nom	Max						
P6KE68	61.2	68	74.8	1	55.1	5	6.1	98	0.104
P6KE68A	64.6	68	71.4	1	58.1	5	6.5	92	0.104
P6KE75	67.5	75	82.5	1	60.7	5	5.5	108	0.105
P6KE75A	71.3	75	78.8	1	64.1	5	5.8	103	0.105
P6KE82	73.8	82	90.2	1	66.4	5	5.1	118	0.105
P6KE82A	77.9	82	86.1	1	70.1	5	5.3	113	0.105
P6KE91	81.9	91	100	1	73.7	5	4.5	131	0.106
P6KE91A	86.5	91	95.5	1	77.8	5	4.8	125	0.106
P6KE100	90	100	110	1	81	5	4.2	144	0.106
P6KE100A	95	100	105	1	85.5	5	4.4	137	0.106
P6KE110	99	110	121	1	89.2	5	3.8	158	0.107
P6KE110A	105	110	116	1	94	5	4	152	0.107
P6KE120	108	120	132	1	97.2	5	3.5	173	0.107
P6KE120A	114	120	126	1	102	5	3.6	165	0.107
P6KE130	117	130	143	1	105	5	3.2	187	0.107
P6KE130A	124	130	137	1	111	5	3.3	179	0.107
P6KE150	135	150	165	1	121	5	2.8	215	0.108
P6KE150A	143	150	158	1	128	5	2.9	207	0.108
P6KE160	144	160	176	1	130	5	2.6	230	0.108
P6KE160A	152	160	168	1	136	5	2.7	219	0.108
P6KE170	153	170	187	1	138	5	2.5	244	0.108
P6KE170A	162	170	179	1	145	5	2.6	234	0.108
P6KE180	162	180	198	1	146	5	2.3	258	0.108
P6KE180A	171	180	189	1	154	5	2.4	246	0.108
P6KE200	180	200	220	1	162	5	2.1	287	0.108
P6KE200A	190	200	210	1	171	5	2.2	274	0.108

* V_{BR} measured after I_T applied for 300 μs . I_T = square wave pulse or equivalent.

** 1/2 sine wave (or equivalent square wave), $PW = 8.3\text{ ms}$, duty cycle = 4 pulses per minute maximum.

† Surge current waveform per Figure 4 and derate per Figure 2.

FOR BIDIRECTIONAL APPLICATIONS — USE C or CA SUFFIX

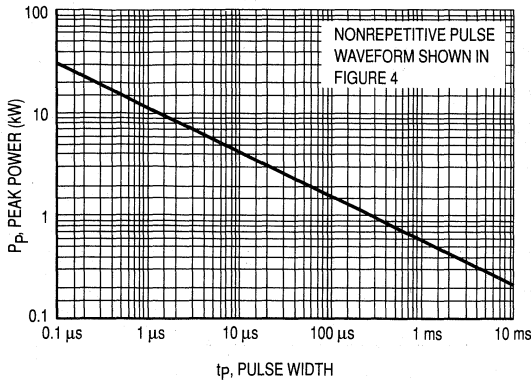

Figure 1. Pulse Rating Curve

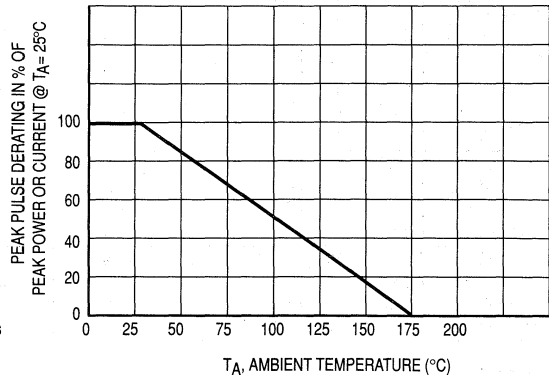

Figure 2. Pulse Derating Curve

P6KE6.8, A thru P6KE200, A

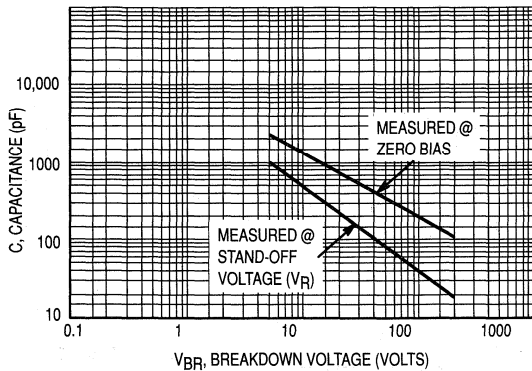

Figure 3. Capacitance versus Breakdown Voltage

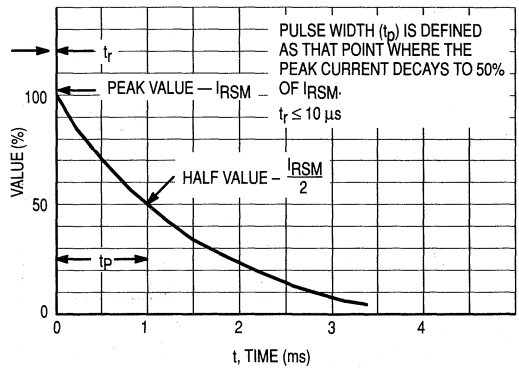

Figure 4. Pulse Waveform

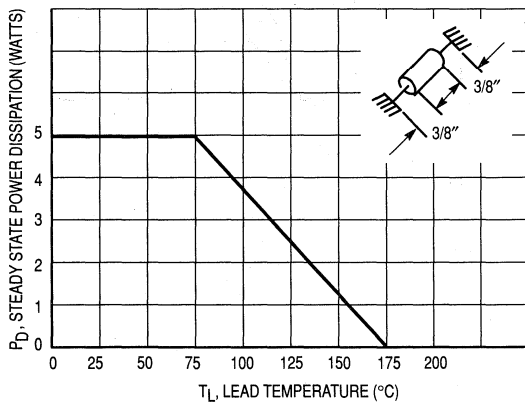

Figure 5. Steady State Power Derating

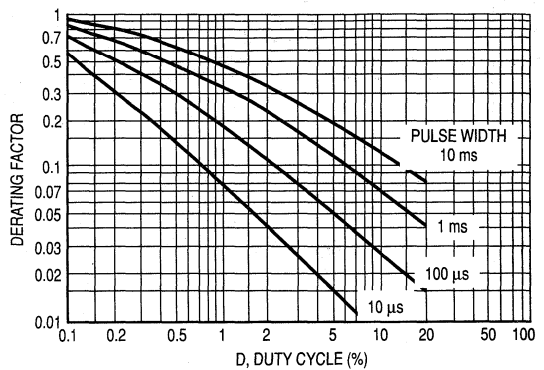

Figure 6. Typical Derating Factor for Duty Cycle

APPLICATION NOTES

RESPONSE TIME

In most applications, the transient suppressor device is placed in parallel with the equipment or component to be protected. In this situation, there is a time delay associated with the capacitance of the device and an overshoot condition associated with the inductance of the device and the inductance of the connection method. The capacitance effect is of minor importance in the parallel protection scheme because it only produces a time delay in the transition from the operating voltage to the clamp voltage as shown in Figure A.

The inductive effects in the device are due to actual turn-on time (time required for the device to go from zero current to full current) and lead inductance. This inductive effect produces an overshoot in the voltage across the equipment or component being protected as shown in Figure B. Minimizing this overshoot is very important in the application, since the main purpose for adding a transient suppressor is to clamp voltage spikes. The P6KE6.8 series has very good response time, typically < 1 ns and negligible inductance. However, external inductive effects could produce unacceptable overshoot. Proper circuit layout, minimum lead lengths and placing the suppressor device as close as possible to the equipment or components to be protected will minimize this overshoot.

Some input impedance represented by Z_{IN} is essential to prevent overstress of the protection device. This impedance should be as high as possible, without restricting the circuit operation.

DUTY CYCLE DERATING

The data of Figure 1 applies for non-repetitive conditions and at a lead temperature of 25°C. If the duty cycle increases, the peak power must be reduced as indicated by the curves of Figure 6. Average power must be derated as the lead or ambient temperature rises above 25°C. The average power derating curve normally given on data sheets may be normalized and used for this purpose.

At first glance the derating curves of Figure 6 appear to be in error as the 10 ms pulse has a higher derating factor than the 10 μs pulse. However, when the derating factor for a given pulse of Figure 6 is multiplied by the peak power value of Figure 1 for the same pulse, the results follow the expected trend.

4

4.1

P6KE6.8, A thru P6KE200, A

TYPICAL PROTECTION CIRCUIT

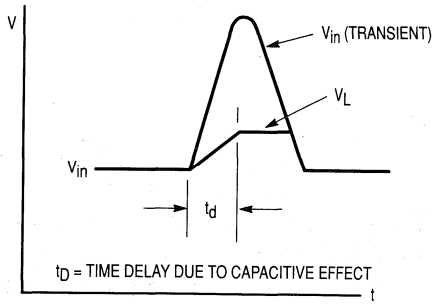
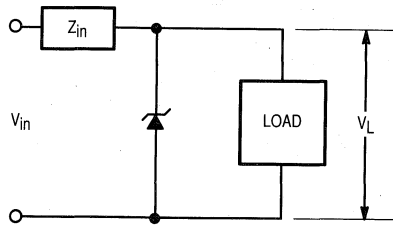

Figure 7.

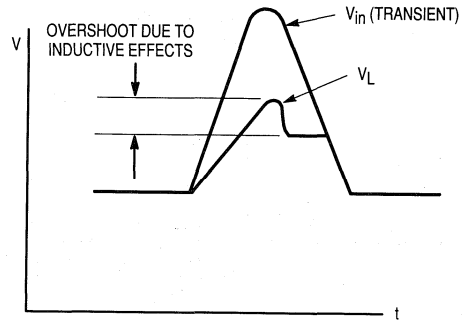

Figure 8.

4

4.1

UL RECOGNITION

The entire series including the bidirectional C and CA suffixes has *Underwriters Laboratory Recognition* for the classification of protectors (QVGV2) under the UL standard for safety 497B. Many competitors only have one or two devices recognized or have recognition in a non-protective category. Some competitors have no recognition at all. With the UL497B recognition, our parts successfully passed several tests including

Strike Voltage Breakdown test, Endurance Conditioning, Temperature test, Dielectric Voltage-Withstand test, Discharge test and several more.

Whereas, some competitors have only passed a flammability test for the package material, we have been recognized for much more to be included in their protector category.

SECTION 4.1.4 DATA SHEETS
TRANSIENT VOLTAGE SUPPRESSORS — continued

Section 4.1.4.1 Axial Leaded — continued

SECTION 4.1.4.1.3 1500 WATT PEAK POWER

4

DATA SHEETS

Devices	Page No.
General Data — 1500 Watt	4-1-38
1N5908	4-1-42
1N6267 thru 1N6303A, 1.5KE6.8 thru 1.5KE250A	4-1-43
1N6373 thru 1N6389, ICTE-5 thru ICTE-45C, MPTE-5 thru MPTE-45C	4-1-46

MULTIPLE PACKAGE QUANTITY (MPQ)
REQUIREMENTS

Package Option	Type No. Suffix	MPQ (Units)
Tape and Reel	RL4	1.5K

4.1

1500 Watt MOSORB

GENERAL DATA APPLICABLE TO ALL SERIES IN THIS GROUP

**Zener Transient Voltage Suppressors
 Unidirectional and Bidirectional**

Mosorb devices are designed to protect voltage sensitive components from high voltage, high energy transients. They have excellent clamping capability, high surge capability, low zener impedance and fast response time. These devices are Motorola's exclusive, cost-effective, highly reliable Surmetic axial leaded package and are ideally-suited for use in communication systems, numerical controls, process controls, medical equipment, business machines, power supplies and many other industrial/consumer applications, to protect CMOS, MOS and Bipolar integrated circuits.

Specification Features:

- Standard Voltage Range — 6.2 to 250 V
- Peak Power — 1500 Watts @ 1 ms
- Maximum Clamp Voltage @ Peak Pulse Current
- Low Leakage < 5 μ A Above 10 V
- UL Recognition

Mechanical Characteristics:

CASE: Void-free, transfer-molded, thermosetting plastic

FINISH: All external surfaces are corrosion resistant and leads are readily solderable

POLARITY: Cathode indicated by polarity band. When operated in zener mode, will be positive with respect to anode

MOUNTING POSITION: Any

**GENERAL
 DATA
 1500 WATT
 PEAK POWER**

**MOSORB
 ZENER OVERVOLTAGE
 TRANSIENT
 SUPPRESSORS
 6.2-250 VOLTS
 1500 WATT PEAK POWER
 5 WATTS STEADY STATE**

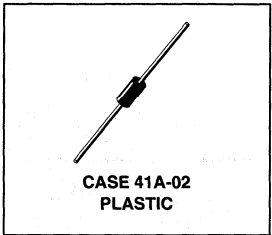

4

4.1

MAXIMUM RATINGS				
	Rating	Symbol	Value	Unit
Peak Power Dissipation (1)		P_{PK}	1500	Watts
	@ $T_L \leq 25^\circ\text{C}$			
Steady State Power Dissipation		P_D	5	Watts
	@ $T_L \leq 75^\circ\text{C}$, Lead Length = 3/8"		50	mW/°C
	Derated above $T_L = 75^\circ\text{C}$			
Forward Surge Current (2)		I_{FSM}	200	Amps
	@ $T_A = 25^\circ\text{C}$			
Operating and Storage Temperature Range		T_J, T_{stg}	- 65 to +175	°C

Lead temperature not less than 1/16" from the case for 10 seconds: 230°C

NOTES: 1. Nonrepetitive current pulse per Figure 5 and derated above $T_A = 25^\circ\text{C}$ per Figure 2.
 2. 1/2 sine wave (or equivalent square wave), PW = 8.3 ms, duty cycle = 4 pulses per minute maximum.

GENERAL DATA — 1500 WATT PEAK POWER

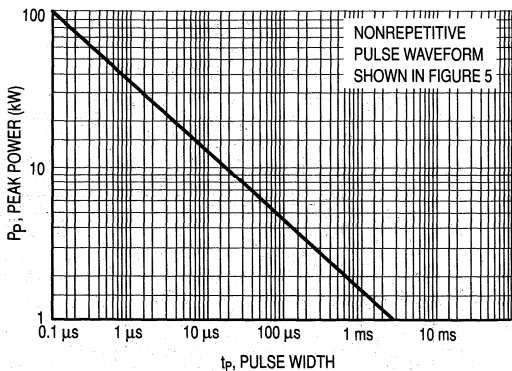

Figure 1. Pulse Rating Curve

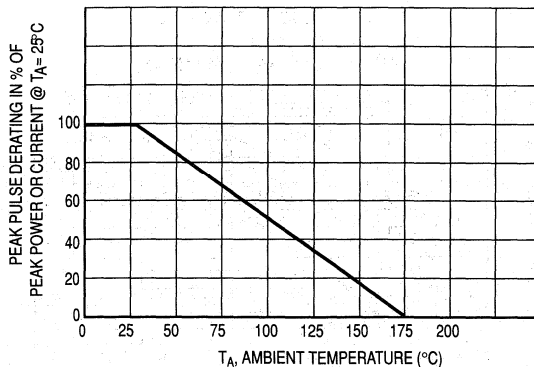

Figure 2. Pulse Derating Curve

1N6373, ICTE-5, MPTE-5,
thru
1N6389, ICTE-45, C, MPTE-45, C

1N6267, A/1.5KE6.8, A
thru
1N6303, A/1.5KE200, A

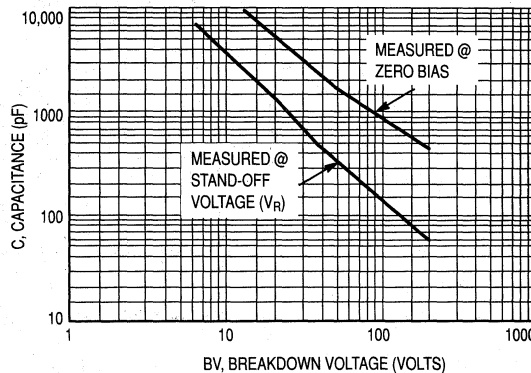
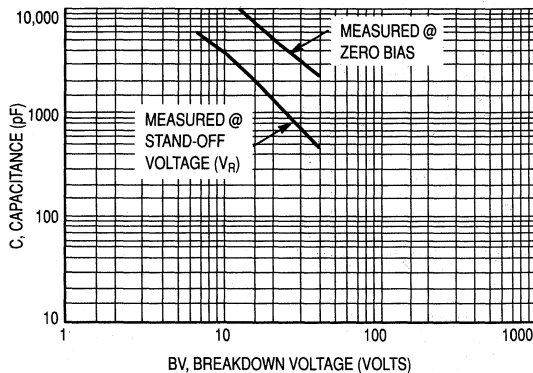

Figure 3. Capacitance versus Breakdown Voltage

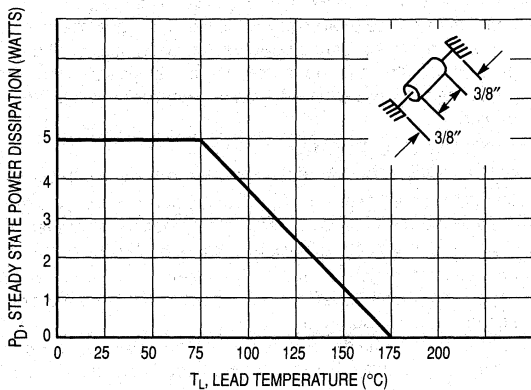

Figure 4. Steady State Power Derating

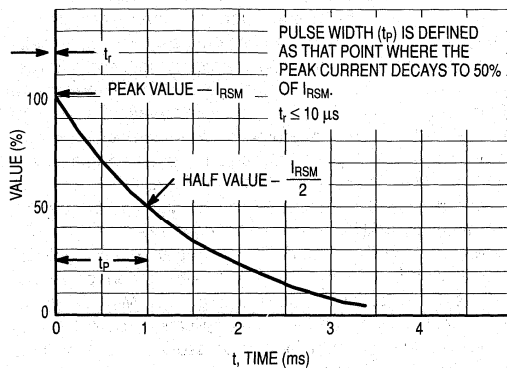

Figure 5. Pulse Waveform

4

4.1

GENERAL DATA — 1500 WATT PEAK POWER

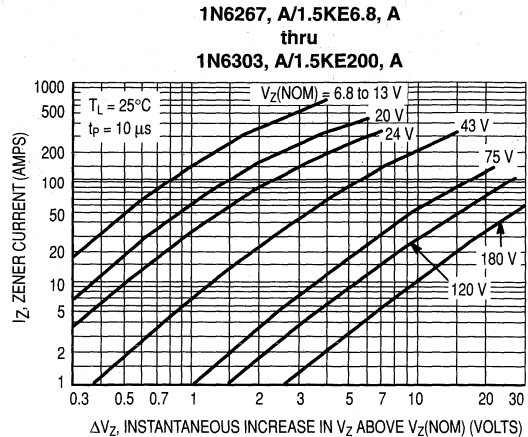
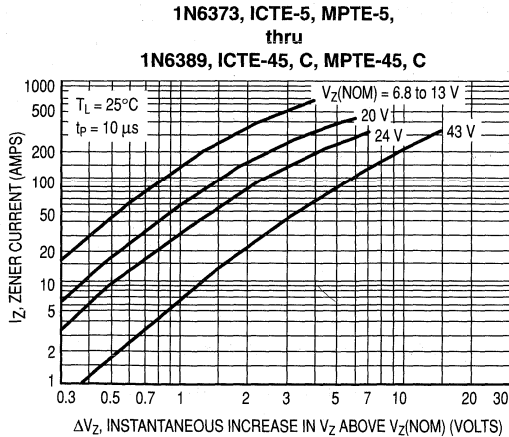

Figure 6. Dynamic Impedance

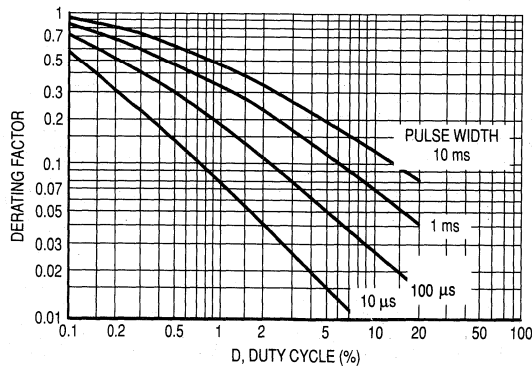

Figure 7. Typical Derating Factor for Duty Cycle

APPLICATION NOTES

RESPONSE TIME

In most applications, the transient suppressor device is placed in parallel with the equipment or component to be protected. In this situation, there is a time delay associated with the capacitance of the device and an overshoot condition associated with the inductance of the device and the inductance of the connection method. The capacitance effect is of minor importance in the parallel protection scheme because it only produces a time delay in the transition from the operating voltage to the clamp voltage as shown in Figure A.

The inductive effects in the device are due to actual turn-on time (time required for the device to go from zero current to full current) and lead inductance. This inductive effect produces an overshoot in the voltage across the equipment or component being protected as shown in Figure B. Minimizing this overshoot is very important in the application, since the main purpose for adding a transient suppressor is to clamp voltage spikes. These devices have excellent response time, typically in the picosecond range and negligible inductance. However, external inductive effects could produce unacceptable over-

shoot. Proper circuit layout, minimum lead lengths and placing the suppressor device as close as possible to the equipment or components to be protected will minimize this overshoot.

Some input impedance represented by Z_{in} is essential to prevent overstress of the protection device. This impedance should be as high as possible, without restricting the circuit operation.

DUTY CYCLE DERATING

The data of Figure 1 applies for non-repetitive conditions and at a lead temperature of 25°C . If the duty cycle increases, the peak power must be reduced as indicated by the curves of Figure 7. Average power must be derated as the lead or ambient temperature rises above 25°C . The average power derating curve normally given on data sheets may be normalized and used for this purpose.

At first glance the derating curves of Figure 7 appear to be in error as the 10 ms pulse has a higher derating factor than the 10 μs pulse. However, when the derating factor for a given pulse of Figure 7 is multiplied by the peak power value of Figure 1 for the same pulse, the results follow the expected trend.

GENERAL DATA — 1500 WATT PEAK POWER

TYPICAL PROTECTION CIRCUIT

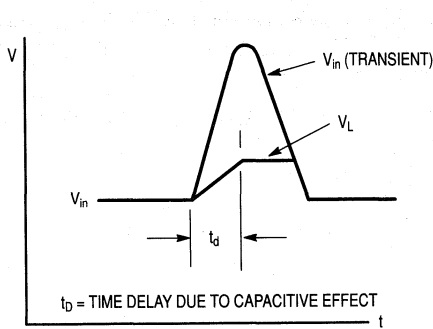
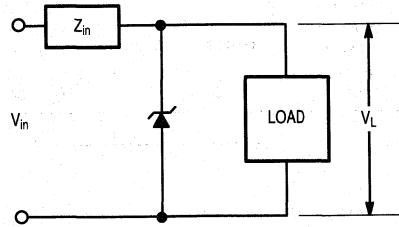

Figure 8.

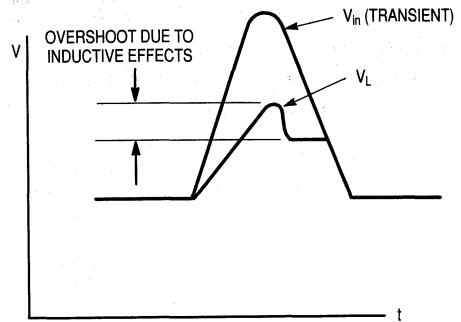

Figure 9.

4

4.1

UL RECOGNITION*

The entire series has *Underwriters Laboratory Recognition* for the classification of protectors (QVGV2) under the UL standard for safety 497B. Many competitors only have one or two devices recognized or have recognition in a non-protective category. Some competitors have no recognition at all. With the UL497B recognition, our parts successfully passed several tests including Strike Voltage Breakdown test, Endurance

Conditioning, Temperature test, Dielectric Voltage-Withstand test, Discharge test and several more.

Whereas, some competitors have only passed a flammability test for the package material, we have been recognized for much more to be included in their Protector category.

*Applies to 1.5KE6.8,A,C,CA thru 1.5KE250,A,C,CA

1N5908

*ELECTRICAL CHARACTERISTICS ($T_A = 25^\circ\text{C}$ unless otherwise noted) $V_F = 3.5\text{ V max}$, $I_F^{**} = 100\text{ A}$							
Device Note 1	Breakdown Voltage		Maximum Reverse Stand-Off Voltage V_{RWM}^{***} (Volts)	Maximum Reverse Leakage @ V_{RWM} I_R (μA)	Maximum Reverse Voltage @ $I_{RSM}^\dagger = 120\text{ A}$ (Clamping Voltage) V_{RSM} (Volts)	Clamping Voltage	
	$V_{BR}^{\dagger\dagger}$ (Volts) Min	@ I_T (mA)				Peak Pulse Current @ $I_{pp1}^\dagger = 30\text{ A}$ V_{C1} (Volts max)	Peak Pulse Current @ $I_{pp2}^\dagger = 60\text{ A}$ V_{C2} (Volts max)
⇒ 1N5908	6	1	5	300	8.5	7.6	8

⇒ Preferred part

NOTE 1: The 1N5908 is JEDEC registered as a unidirectional device only (no bidirectional option).

* Indicates JEDEC registered data.

** 1/2 sine wave (or equivalent square wave), $PW = 8.3\text{ ms}$, duty cycle = 4 pulses per minute maximum.

*** A transient suppressor is normally selected according to the maximum reverse stand-off voltage (V_{RWM}), which should be equal to or greater than the dc or continuous peak operating voltage level.

† Surge current waveform per Figure 5 and derate per Figure 2 of the General Data — 1500 W at the beginning of this group.

†† V_{BR} measured at pulse test current I_T at an ambient temperature of 25°C .

4

4.1

1N6267 thru 1N6303A, 1.5KE6.8 thru 1.5KE250A

*ELECTRICAL CHARACTERISTICS ($T_A = 25^\circ\text{C}$ unless otherwise noted) $V_F\# = 3.5\text{ V Max}$, $I_F^{**} = 100\text{ A}$											
JEDEC Device	Device	Breakdown Voltage				Working Peak Reverse Voltage V_{RWM}^{***} (Volts)	Maximum Reverse Leakage @ V_{RWM} I_R (μA)	Maximum Reverse Surge Current I_{RSM}^\dagger (Amps)	Maximum Reverse Voltage @ I_{RSM} (Clamping Voltage) V_{RSM} (Volts)	Maximum Temperature Coefficient of V_{BR} (%/°C)	
		$V_{BR}^{\dagger\dagger}$ Volts			@ I_T (mA)						
		Min	Nom	Max							
1N6267	1.5KE6.8	6.12	6.8	7.48	10	5.5	1000	139	10.8	0.057	
⇒ 1N6267A	1.5KE6.8A	6.45	6.8	7.14	10	5.8	1000	143	10.5	0.057	
1N6268	1.5KE7.5	6.75	7.5	8.25	10	6.05	500	128	11.7	0.061	
1N6268A	1.5KE7.5A	7.13	7.5	7.88	10	6.4	500	132	11.3	0.061	
1N6269	1.5KE8.2	7.38	8.2	9.02	10	6.63	200	120	12.5	0.065	
1N6269A	1.5KE8.2A	7.79	8.2	8.61	10	7.02	200	124	12.1	0.065	
1N6270	1.5KE9.1	8.19	9.1	10	1	7.37	50	109	13.8	0.068	
1N6270A	1.5KE9.1A	8.65	9.1	9.55	1	7.78	50	112	13.4	0.068	
1N6271	1.5KE10	9	10	11	1	8.1	10	100	15	0.073	
1N6271A	1.5KE10A	9.5	10	10.5	1	8.55	10	103	14.5	0.073	
1N6272	1.5KE11	9.9	11	12.1	1	8.92	5	93	16.2	0.075	
1N6272A	1.5KE11A	10.5	11	11.6	1	9.4	5	96	15.6	0.075	
1N6273	1.5KE12	10.8	12	13.2	1	9.72	5	87	17.3	0.078	
1N6273A	1.5KE12A	11.4	12	12.6	1	10.2	5	90	16.7	0.078	
1N6274	1.5KE13	11.7	13	14.3	1	10.5	5	79	19	0.081	
1N6274A	1.5KE13A	12.4	13	13.7	1	11.1	5	82	18.2	0.081	
1N6275	1.5KE15	13.5	15	16.5	1	12.1	5	68	22	0.084	
1N6275A	1.5KE15A	14.3	15	15.8	1	12.8	5	71	21.2	0.084	
1N6276	1.5KE16	14.4	16	17.6	1	12.9	5	64	23.5	0.086	
1N6276A	1.5KE16A	15.2	16	16.8	1	13.6	5	67	22.5	0.086	
1N6277	1.5KE18	16.2	18	19.8	1	14.5	5	56.5	26.5	0.088	
1N6277A	1.5KE18A	17.1	18	18.9	1	15.3	5	59.5	25.2	0.088	
1N6278	1.5KE20	18	20	22	1	16.2	5	51.5	29.1	0.09	
1N6278A	1.5KE20A	19	20	21	1	17.1	5	54	27.7	0.09	
1N6279	1.5KE22	19.8	22	24.2	1	17.8	5	47	31.9	0.092	
1N6279A	1.5KE22A	20.9	22	23.1	1	18.8	5	49	30.6	0.092	
1N6280	1.5KE24	21.6	24	26.4	1	19.4	5	43	34.7	0.094	
⇒ 1N6280A	1.5KE24A	22.8	24	25.2	1	20.5	5	45	33.2	0.094	
1N6281	1.5KE27	24.3	27	29.7	1	21.8	5	38.5	39.1	0.096	
1N6281A	1.5KE27A	25.7	27	28.4	1	23.1	5	40	37.5	0.096	
1N6282	1.5KE30	27	30	33	1	24.3	5	34.5	43.5	0.097	
⇒ 1N6282A	1.5KE30A	28.5	30	31.5	1	25.6	5	36	41.4	0.097	
1N6283	1.5KE33	29.7	33	36.3	1	26.8	5	31.5	47.7	0.098	
1N6283A	1.5KE33A	31.4	33	34.7	1	28.2	5	33	45.7	0.098	
1N6284	1.5KE36	32.4	36	39.6	1	29.1	5	29	52	0.099	
⇒ 1N6284A	1.5KE36A	34.2	36	37.8	1	30.8	5	30	49.9	0.099	
1N6285	1.5KE39	35.1	39	42.9	1	31.6	5	26.5	56.4	0.1	
1N6285A	1.5KE39A	37.1	39	41	1	33.3	5	28	53.9	0.1	
1N6286	1.5KE43	38.7	43	47.3	1	34.8	5	24	61.9	0.101	
1N6286A	1.5KE43A	40.9	43	45.2	1	36.8	5	25.3	59.3	0.101	
1N6287	1.5KE47	42.3	47	51.7	1	38.1	5	22.2	67.8	0.101	
1N6287A	1.5KE47A	44.7	47	49.4	1	40.2	5	23.2	64.8	0.101	
1N6288	1.5KE51	45.9	51	56.1	1	41.3	5	20.4	73.5	0.102	
⇒ 1N6288A	1.5KE51A	48.5	51	53.6	1	43.6	5	21.4	70.1	0.102	

(continued)

⇒ Preferred part
FOR BIDIRECTIONAL APPLICATIONS
— USE C or CA SUFFIX ON 1.5KE SERIES

Preferred Bidirectional Devices —
1.5KE10CA 1.5KE12CA
1.5KE18CA 1.5KE36CA

4

4.1

1N6267 thru 1N6303A, 1.5KE6.8 thru 1.5KE250A

***ELECTRICAL CHARACTERISTICS — continued** ($T_A = 25^\circ\text{C}$ unless otherwise noted) $V_F\# = 3.5\text{ V Max}$, $I_F^{**} = 100\text{ A}$

JEDEC Device	Device	Breakdown Voltage				Working Peak Reverse Voltage V_{RWM}^{***} (Volts)	Maximum Reverse Leakage @ V_{RWM} I_R (μA)	Maximum Reverse Surge Current I_{RSM}^\dagger (Amps)	Maximum Reverse Voltage @ I_{RSM} (Clamping Voltage) V_{RSM} (Volts)	Maximum Temperature Coefficient of V_{BR} (%/°C)
		$V_{BR}^{\dagger\dagger}$ Volts			@ I_T (mA)					
		Min	Nom	Max						
1N6289	1.5KE56	50.4	56	61.6	1	45.4	5	18.6	80.5	0.103
1N6289A	1.5KE56A	53.2	56	58.8	1	47.8	5	19.5	77	0.103
1N6290	1.5KE62	55.8	62	68.2	1	50.2	5	16.9	89	0.104
⇒ 1N6290A	1.5KE62A	58.9	62	65.1	1	53	5	17.7	85	0.104
1N6291	1.5KE68	61.2	68	74.8	1	55.1	5	15.3	98	0.104
1N6291A	1.5KE68A	64.6	68	71.4	1	58.1	5	16.3	92	0.104
1N6292	1.5KE75	67.5	75	82.5	1	60.7	5	13.9	108	0.105
1N6292A	1.5KE75A	71.3	75	78.8	1	64.1	5	14.6	103	0.105
1N6293	1.5KE82	73.8	82	90.2	1	66.4	5	12.7	118	0.105
1N6293A	1.5KE82A	77.9	82	86.1	1	70.1	5	13.3	113	0.105
1N6294	1.5KE91	81.9	91	100	1	73.7	5	11.4	131	0.106
1N6294A	1.5KE91A	86.5	91	95.5	1	77.8	5	12	125	0.106
1N6295	1.5KE100	90	100	110	1	81	5	10.4	144	0.106
1N6295A	1.5KE100A	95	100	105	1	85.5	5	11	137	0.106
1N6296	1.5KE110	99	110	121	1	89.2	5	9.5	158	0.107
1N6296A	1.5KE110A	105	110	116	1	94	5	9.9	152	0.107
1N6297	1.5KE120	108	120	132	1	97.2	5	8.7	173	0.107
1N6297A	1.5KE120A	114	120	126	1	102	5	9.1	165	0.107
1N6298	1.5KE130	117	130	143	1	105	5	8	187	0.107
1N6298A	1.5KE130A	124	130	137	1	111	5	8.4	179	0.107
1N6299	1.5KE150	135	150	165	1	121	5	7	215	0.108
1N6299A	1.5KE150A	143	150	158	1	128	5	7.2	207	0.108
1N6300	1.5KE160	144	160	176	1	130	5	6.5	230	0.108
1N6300A	1.5KE160A	152	160	168	1	136	5	6.8	219	0.108
1N6301	1.5KE170	153	170	187	1	138	5	6.2	244	0.108
1N6301A	1.5KE170A	162	170	179	1	145	5	6.4	234	0.108
1N6302	1.5KE180	162	180	198	1	146	5	5.8	258	0.108
1N6302A	1.5KE180A	171	180	189	1	154	5	6.1	246	0.108
1N6303	1.5KE200	180	200	220	1	162	5	5.2	287	0.108
1N6303A	1.5KE200A	190	200	210	1	171	5	5.5	274	0.108
	1.5KE220	198	220	242	1	175	5	4.3	344	0.109
	1.5KE220A	209	220	231	1	185	5	4.6	328	0.109
	1.5KE250	225	250	275	1	202	5	5	360	0.109
	1.5KE250A	237	250	263	1	214	5	5	344	0.109

⇒ Preferred part

* Indicates JEDEC registered data.

** 1/2 sine wave (or equivalent square wave), PW = 8.3 ms, duty cycle = 4 pulses per minute maximum.

*** A transient suppressor is normally selected according to the maximum reverse stand-off voltage (V_{RWM}), which should be equal to or greater than the dc or continuous peak operating voltage level.

† Surge current waveform per Figure 5 and derate per Figure 2 of the General Data — 1500 W at the beginning of this group.

†† V_{BR} measured at pulse test current I_T at an ambient temperature of 25°C .

V_F applies to Non-C suffix devices only.

FOR BIDIRECTIONAL APPLICATIONS — USE C or CA SUFFIX ON 1.5KE SERIES

1N6267 thru 1N6303A, 1.5KE6.8 thru 1.5KE250A

CLIPPER BIDIRECTIONAL DEVICES

1. Clipper-bidirectional devices are available in the 1.5KEXX series and are designated with a "C" or a "CA" suffix; for example, 1.5KE18CA. Contact your nearest Motorola representative.
2. Clipper-bidirectional part numbers are tested in both directions to electrical parameters in preceding table (except for V_F which does not apply).
3. The 1N6267 thru 1N6303 series are JEDEC registered devices and the registration does not include "C" and "CA" suffixes. To order clipper-bidirectional devices one must add C or CA to the 1.5KE device title.

1N6373 thru 1N6389, ICTE-5 thru ICTE-45C, MPTE-5 thru MPTE-45C

*ELECTRICAL CHARACTERISTICS ($T_A = 25^\circ\text{C}$ unless otherwise noted) $V_F = 3.5\text{ V Max}$, $I_F = 100\text{ A}$ (C suffix denotes standard back to back bidirectional versions. Test both polarities)									
JEDEC Device Note 1	Device Note 1	Breakdown ^{††} Voltage		Maximum Reverse Stand-Off Voltage V_{RWM}^{***} (Volts)	Maximum Reverse Leakage @ V_{RWM} I_R (μA)	Maximum Reverse Surge Current I_{RSM}^\dagger (Amps)	Maximum Reverse Voltage @ I_{RSM}^\dagger (Clamping Voltage) V_{RSM} (Volts)	Clamping Voltage	
		V_{BR} Volts Min	@ I_T (mA)					Peak Pulse Current @ $I_{PP1}^\dagger = 1\text{ A}$ V_{C1} (Volts max)	Peak Pulse Current @ $I_{PP2}^\dagger = 10\text{ A}$ V_{C2} (Volts max)
⇒ 1N6373	ICTE-5/MPTE-5	6	1	5	300	160	9.4	7.1	7.5
1N6374	ICTE-8/MPTE-8	9.4	1	8	25	100	15	11.3	11.5
⇒ 1N6382	ICTE-8C/MPTE-8C	9.4	1	8	25	100	15	11.4	11.6
1N6375	ICTE-10/MPTE-10	11.7	1	10	2	90	16.7	13.7	14.1
1N6383	ICTE-10C/MPTE-10C	11.7	1	10	2	90	16.7	14.1	14.5
⇒ 1N6376	ICTE-12/MPTE-12	14.1	1	12	2	70	21.2	16.1	16.5
1N6384	ICTE-12C/MPTE-12C	14.1	1	12	2	70	21.2	16.7	17.1
1N6377	ICTE-15/MPTE-15	17.6	1	15	2	60	25	20.1	20.6
⇒ 1N6385	ICTE-15C/MPTE-15C	17.6	1	15	2	60	25	20.8	21.4
1N6378	ICTE-18/MPTE-18	21.2	1	18	2	50	30	24.2	25.2
1N6386	ICTE-18C/MPTE-18C	21.2	1	18	2	50	30	24.8	25.5
1N6379	ICTE-22/MPTE-22	25.9	1	22	2	40	37.5	29.8	32
1N6387	ICTE-22C/MPTE-22C	25.9	1	22	2	40	37.5	30.8	32
1N6380	ICTE-36/MPTE-36	42.4	1	36	2	23	65.2	50.6	54.3
1N6388	ICTE-36C/MPTE-36C	42.4	1	36	2	23	65.2	50.6	54.3
1N6381	ICTE-45/MPTE-45	52.9	1	45	2	19	78.9	63.3	70
1N6389	ICTE-45C/MPTE-45C	52.9	1	45	2	19	78.9	63.3	70

⇒ Preferred part

NOTE 1: C suffix denotes standard back-to-back bidirectional versions. Test both polarities. JEDEC device types 1N6382 thru 1N6389 are registered as back to back bidirectional versions and do not require a C suffix. 1N6373 thru 1N6381 are registered as unidirectional devices only (no bidirectional option).

* Indicates JEDEC registered data.

** 1/2 sine wave (or equivalent square wave), PW = 8.3 ms, duty cycle = 4 pulses per minute maximum.

*** A transient suppressor is normally selected according to the maximum reverse stand-off voltage (V_{RWM}), which should be equal to or greater than the dc or continuous peak operating voltage level.

† Surge current waveform per Figure 5 and derate per Figure 2 of the General Data — 1500 W at the beginning of this group.

†† V_{BR} measured at pulse test current I_T at an ambient temperature of 25°C .

V_F applies to unidirectional devices only.

SECTION 4.1.4 DATA SHEETS
TRANSIENT VOLTAGE SUPPRESSORS — continued

Section 4.1.4.1 Axial Leaded — continued

SECTION 4.1.4.1.4 AUTOMOTIVE 110 AMP REPETITIVE PEAK

DATA SHEETS

Devices	Page No.
MR2535L	4-1-48

**MULTIPLE PACKAGE QUANTITY (MPQ)
REQUIREMENTS**

Package Option	Type No. Suffix	MPQ (Units)
Tape and Reel	RL	800

4

4.1

Advance Information
Overvoltage
Transient Suppressors

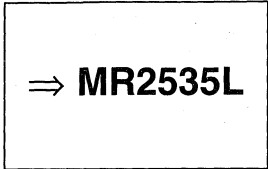

**MEDIUM CURRENT
OVERVOLTAGE
TRANSIENT
SUPPRESSORS**

... designed for applications requiring a low voltage rectifier with reverse avalanche characteristics for use as reverse power transient suppressors. Developed to suppress transients in the automotive system, these devices operate in the forward mode as standard rectifiers or reverse mode as power avalanche rectifier and will protect electronic equipment from overvoltage conditions.

- Avalanche Voltage 24 to 32 Volts
- High Power Capability
- Economical
- Increased Capacity by Parallel Operation

MECHANICAL CHARACTERISTICS:

CASE: Transfer Molded Plastic

MAXIMUM LEAD TEMPERATURE FOR SOLDERING PURPOSES: 350°C 3/8" from case for 10 seconds at 5 lbs. tension

FINISH: All external surfaces are corrosion-resistant, leads are readily solderable

POLARITY: Indicated by diode symbol or cathode band

WEIGHT: 2.5 Grams (approx.)

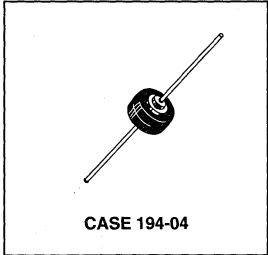

4

4.1

MAXIMUM RATINGS				
Rating	Symbol	Value	Unit	
DC Peak Repetitive Reverse Voltage Working Peak Reverse Voltage DC Blocking Voltage	V_{RRM} V_{RWM} V_R	20	Volts	
Repetitive Peak Reverse Surge Current (Time Constant = 10 ms, Duty Cycle \leq 1%, $T_C = 25^\circ\text{C}$) (See Figure 1)	I_{RSM}	110	Amps	
Average Rectified Forward Current (Single Phase, Resistive Load, 60 Hz, $T_C = 150^\circ\text{C}$)	I_O	35	Amps	
Non-Repetitive Peak Surge Current Surge Supplied at Rated Load Conditions Halfwave, Single Phase	I_{FSM}	600	Amps	
Operating and Storage Junction Temperature Range	T_J, T_{stg}	-65 to +175	$^\circ\text{C}$	

THERMAL CHARACTERISTICS				
Characteristic	Lead Length	Symbol	Max	Unit
Thermal Resistance, Junction to Lead @ Both Leads to Heat Sink, Equal Length	1/4"	$R_{\theta JL}$	7.5	$^\circ\text{C/W}$
	3/8"		10	
	1/2"		13	
Thermal Resistance Junction to Case		$R_{\theta JC}$	0.8*	$^\circ\text{C/W}$

*Typical

⇒ **Preferred part**

This document contains information on a new product. Specifications and information herein are subject to change without notice.

MR2535L

ELECTRICAL CHARACTERISTICS				
Characteristic	Symbol	Min	Max	Unit
Instantaneous Forward Voltage (1) ($I_F = 100$ Amps, $T_C = 25^\circ\text{C}$)	V_F	—	1.1	Volts
Reverse Current ($V_R = 20$ Vdc, $T_C = 25^\circ\text{C}$)	I_R	—	200	nAdc
Breakdown Voltage (1) ($I_R = 100$ mAdc, $T_C = 25^\circ\text{C}$)	$V_{(BR)}$	24	32	Volts
Breakdown Voltage (1) ($I_R = 90$ Amp, $T_C = 150^\circ\text{C}$, $PW = 80 \mu\text{s}$)	$V_{(BR)}$	—	40	Volts
Breakdown Voltage Temperature Coefficient	$V_{(BR)TC}$	—	0.096*	%/ $^\circ\text{C}$
Forward Voltage Temperature Coefficient @ $I_F = 10$ mA	V_{FTC}	—	2*	mV/ $^\circ\text{C}$

(1) Pulse Test: Pulse Width $\leq 300 \mu\text{s}$, Duty Cycle $\leq 2\%$.

*Typical

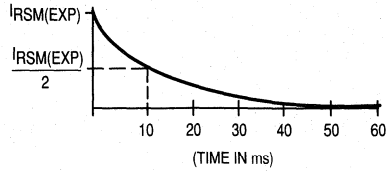

Figure 1. Surge Current Characteristics

4

4.1

SECTION 4.1.4 DATA SHEETS
TRANSIENT VOLTAGE SUPPRESSORS — continued

Section 4.1.4.2 Surface Mounted

SECTION 4.1.4.2.1 40 WATT PEAK POWER

4

DATA SHEETS

Devices	Page No.
MMBZ15VDLT1	4-1-52

MULTIPLE PACKAGE QUANTITY (MPQ)
REQUIREMENTS

Package Option	Type No. Suffix	MPQ (Units)
Tape and Reel	T1	3K

4.1

15 Volt SOT-23 Bipolar Zener For ESD Protection Transient Voltage Suppressor

MMBZ15VDLT1

**SOT-23 BIPOLAR
 ZENER OVERVOLTAGE
 TRANSIENT SUPPRESSOR
 15 VOLT
 40 WATTS PEAK POWER**

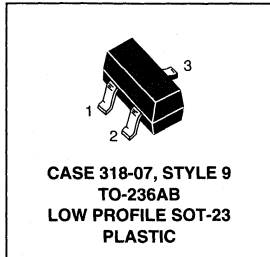

This monolithic silicon zener device is designed for applications requiring transient over-voltage protection capability. It is intended for use in voltage and ESD sensitive equipment such as computers, business machines, communication systems, medical equipment and other applications. The convenient SOT-23 package allows for easy handling and is ideal for situations where space is at a premium.

Specification Features:

- Dual Package Provides for Bidirectional or Separate Unidirectional Configurations
- Economical SOT-23 Surface Mount Package
- Peak Power — 40 Watts @ 1 ms (Bidirectional)
- Maximum Clamping Voltage @ Peak Pulse Current
- Low Leakage < 100 nA

Mechanical Characteristics:

Case: Void free, transfer-molded, thermosetting plastic
Finish: All external surfaces are corrosion resistant and leads are readily solderable
Packaging: Available in 8 mm embossed tape and reel (3000 devices per reel)
Pinout: Terminal 1 — Anode
 Terminal 2 — Anode
 Terminal 3 — Cathode

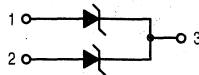

4

MAXIMUM RATINGS ($T_C = 25^\circ\text{C}$ Unless Otherwise Noted.)

Rating	Symbol	Value	Unit
Peak Power Dissipation (1) @ $T_A \leq 25^\circ\text{C}$	P_{pk}	40	Watts
Total Power Dissipation on FR-5 Board (2) @ $T_A = 25^\circ\text{C}$ Derate above 25°C	P_D	225 1.8	mW mW/ $^\circ\text{C}$
Total Power Dissipation on Alumina Substrate (3) @ $T_A = 25^\circ\text{C}$ Derate above 25°C	P_D	300 2.4	mW mW/ $^\circ\text{C}$
Operating and Storage Temperature Range	T_J, T_{stg}	-55 to +150	$^\circ\text{C}$

(1) Nonrepetitive current pulse per Figure 5 and derate above $T_A = 25^\circ\text{C}$ per Figure 6.
 (2) FR-5 = 1.0 x 0.75 x 0.62 in.
 (3) Alumina = 0.4 x 0.3 x 0.024 in., 99.5% alumina

4.1

THERMAL CHARACTERISTICS

Thermal Resistance — Junction to Ambient	$R_{\theta JA}$	556	$^\circ\text{C}/\text{W}$
Maximum Lead Temperature for Soldering Purposes (10 seconds max.)	T_L	230	$^\circ\text{C}$

ELECTRICAL CHARACTERISTICS ($T_A = 25^\circ\text{C}$ Unless Otherwise Noted)

BIDIRECTIONAL (Circuit tied to pins 1 and 2)

Breakdown Voltage			@ I_T mA	Working Peak Reverse Voltage V_{RWM} (Volts)	Maximum Reverse Leakage Current I_{RWM} I_R (nA)	Maximum Reverse Surge Current I_{RSM}^\dagger (Amps)	Maximum Reverse Voltage @ I_{RSM} (Clamping Voltage) V_{RSM}^\dagger (Volts)	Maximum Temperature Coefficient of V_{BR} (mV/ $^\circ\text{C}$)
Min	Nom	Max						
14.3	15	15.8	1.0	12.8	100	1.9	21.2	12

† Surge current waveform per Figure 5 and derate per Figure 6.
 $^\dagger^\dagger$ V_{BR} measured at pulse test current I_T at an ambient temperature of 25°C .

MMBZ15VDLT1

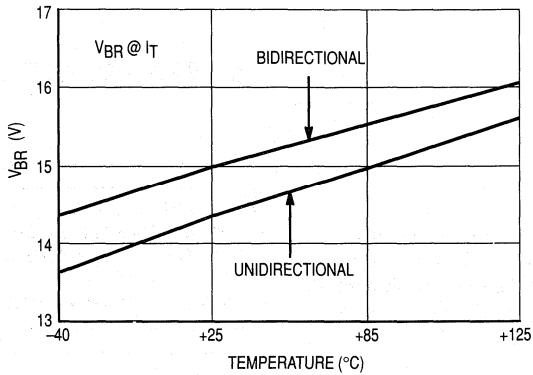

Figure 1. Typical V_{BR} versus Temperature

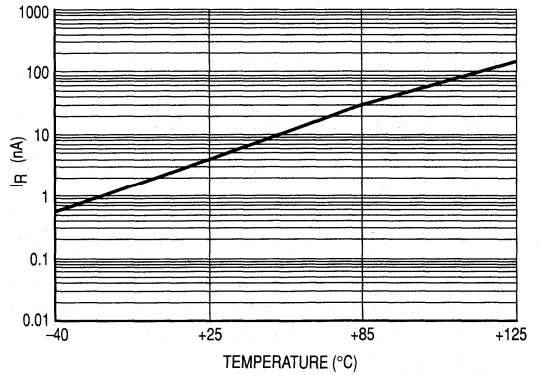

Figure 2. Typical Leakage Current versus Temperature

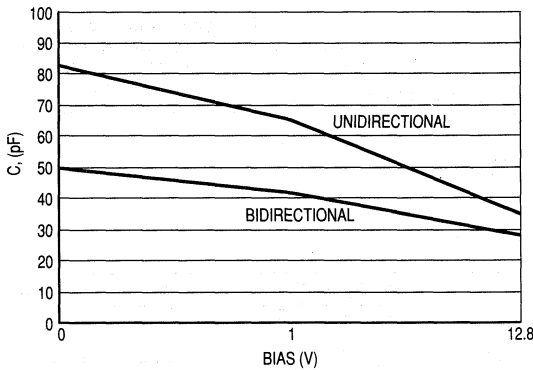

Figure 3. Typical Capacitance versus Bias Voltage

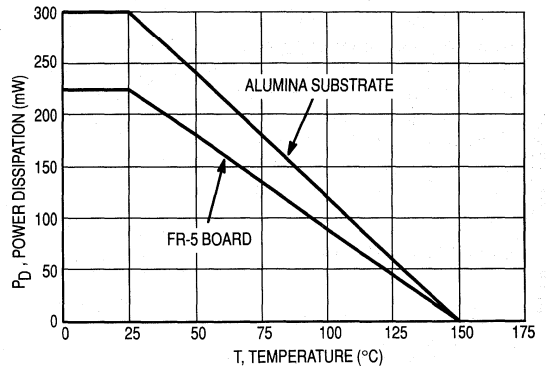

Figure 4. Steady State Power Derating Curve

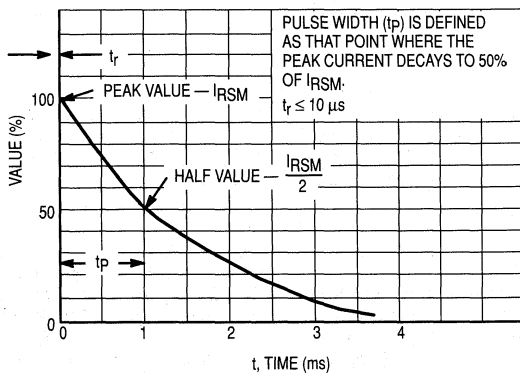

Figure 5. Pulse Waveform

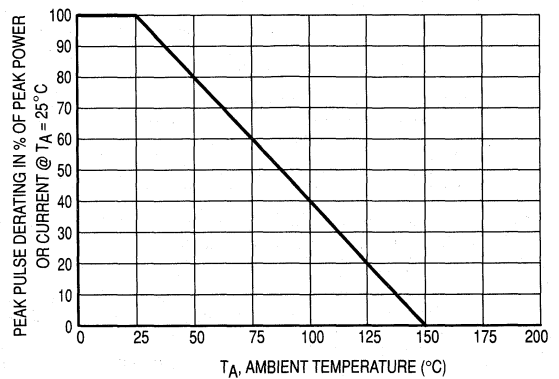

Figure 6. Pulse Derating Curve

4

4.1

4

4.1

SECTION 4.1.4 DATA SHEETS
TRANSIENT VOLTAGE SUPPRESSORS — continued

Section 4.1.4.2 Surface Mounted — continued

SECTION 4.1.4.2.2 600 WATT PEAK POWER

DATA SHEETS

Devices	Page No.
General Data — 600 Watt	4-1-56
1SMB5.0AT3 thru 1SMB170AT3	4-1-59
P6SMB6.8AT3 thru P6SMB200AT3	4-1-60

MULTIPLE PACKAGE QUANTITY (MPQ)
REQUIREMENTS

Package Option	Type No. Suffix	MPQ (Units)
Tape and Reel	T3 ⁽¹⁾	2.5K

NOTE 1. The "3" on the suffix designates reel size (13") and full reel quantity of 2.5K.

**GENERAL DATA APPLICABLE TO ALL SERIES IN
THIS GROUP
Zener Transient Voltage Suppressors**

The SMB series is designed to protect voltage sensitive components from high voltage, high energy transients. They have excellent clamping capability, high surge capability, low zener impedance and fast response time. The SMB series is supplied in Motorola's exclusive, cost-effective, highly reliable Surmetic package and is ideally suited for use in communication systems, numerical controls, process controls, medical equipment, business machines, power supplies and many other industrial/consumer applications.

Specification Features:

- Standard Zener Breakdown Voltage Range — 6.8 to 200 V
- Stand-off Voltage Range — 5 to 170 V
- Peak Power — 600 Watts @ 1 ms
- Maximum Clamp Voltage @ Peak Pulse Current
- Low Leakage < 5 μ A Above 10 V

Mechanical Characteristics:

CASE: Void-free, transfer-molded, thermosetting plastic

FINISH: All external surfaces are corrosion resistant and leads are readily solderable

POLARITY: Cathode indicated by molded polarity notch. When operated in zener mode, will be positive with respect to anode

MOUNTING POSITION: Any

LEADS: Modified L-Bend providing more contact area to bond pad

MAXIMUM CASE TEMPERATURE FOR SOLDERING PURPOSES: 230°C for 10 seconds

**GENERAL
DATA
600 WATT
PEAK POWER**

**PLASTIC SURFACE MOUNT
ZENER OVERVOLTAGE
TRANSIENT
SUPPRESSORS
6.8-200 VOLT
600 WATT PEAK POWER**

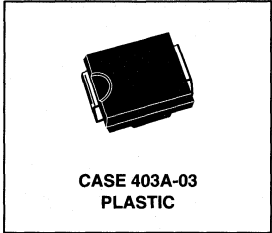

4

4.1

MAXIMUM RATINGS			
Rating	Symbol	Value	Unit
Peak Power Dissipation (1) @ $T_L \leq 25^\circ\text{C}$	PPK	600	Watts
Forward Surge Current (2) @ $T_A = 25^\circ\text{C}$	IFSM	100	Amps
Operating and Storage Temperature Range	T_J, T_{stg}	- 65 to +175	$^\circ\text{C}$

NOTES: 1. Nonrepetitive current pulse per Figure 2 and derated above $T_A = 25^\circ\text{C}$ per Figure 3.
2. 1/2 sine wave (or equivalent square wave), PW = 8.3 ms, duty cycle = 4 pulses per minute maximum.

GENERAL DATA — 600 WATT PEAK POWER

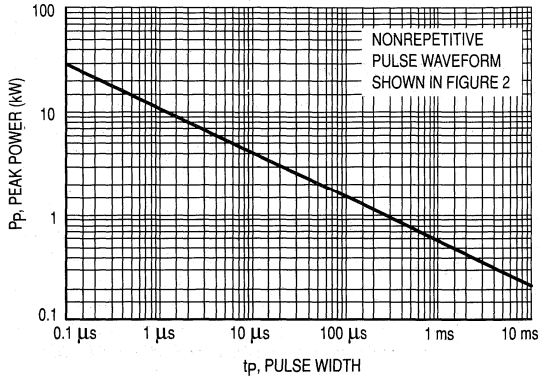

Figure 1. Pulse Rating Curve

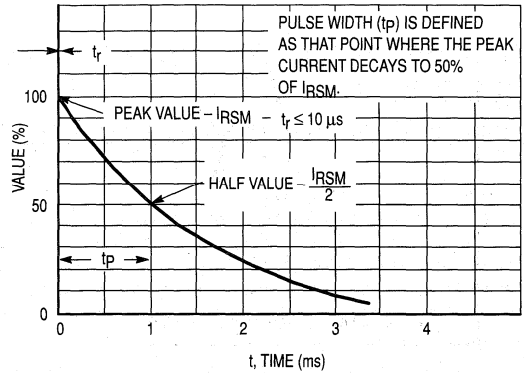

Figure 2. Pulse Waveform

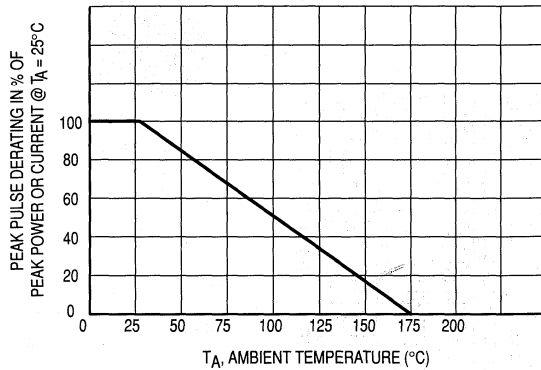
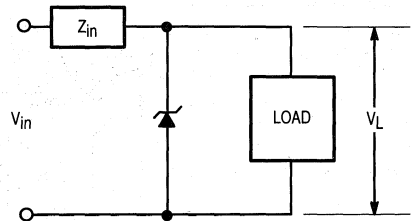

Figure 3. Pulse Derating Curve

TYPICAL PROTECTION CIRCUIT



4

4.1

APPLICATION NOTES

RESPONSE TIME

In most applications, the transient suppressor device is placed in parallel with the equipment or component to be protected. In this situation, there is a time delay associated with the capacitance of the device and an overshoot condition associated with the inductance of the device and the inductance of the connection method. The capacitive effect is of minor importance in the parallel protection scheme because it only produces a time delay in the transition from the operating voltage to the clamp voltage as shown in Figure 4.

The inductive effects in the device are due to actual turn-on time (time required for the device to go from zero current to full current) and lead inductance. This inductive effect produces an overshoot in the voltage across the equipment or component being protected as shown in Figure 5. Minimizing this overshoot is very important in the application, since the main purpose for adding a transient suppressor is to clamp voltage spikes. The SMB series have a very good response time, typically < 1 ns and negligible inductance. However, external inductive effects could produce unacceptable overshoot. Proper circuit layout, minimum lead lengths and placing the suppressor

device as close as possible to the equipment or components to be protected will minimize this overshoot.

Some input impedance represented by Z_{in} is essential to prevent overstress of the protection device. This impedance should be as high as possible, without restricting the circuit operation.

DUTY CYCLE DERATING

The data of Figure 1 applies for non-repetitive conditions and at a lead temperature of 25°C. If the duty cycle increases, the peak power must be reduced as indicated by the curves of Figure 6. Average power must be derated as the lead or ambient temperature rises above 25°C. The average power derating curve normally given on data sheets may be normalized and used for this purpose.

At first glance the derating curves of Figure 6 appear to be in error as the 10 ms pulse has a higher derating factor than the 10 μ s pulse. However, when the derating factor for a given pulse of Figure 6 is multiplied by the peak power value of Figure 1 for the same pulse, the results follow the expected trend.

GENERAL DATA — 600 WATT PEAK POWER

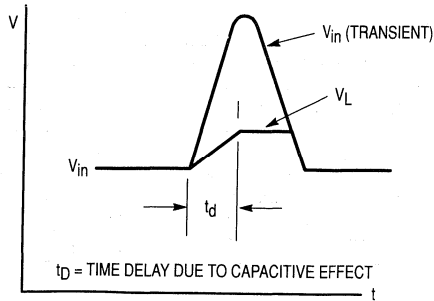

Figure 4.

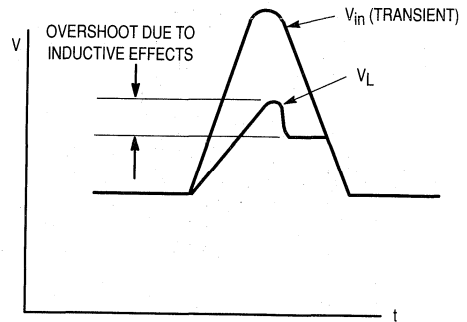

Figure 5.

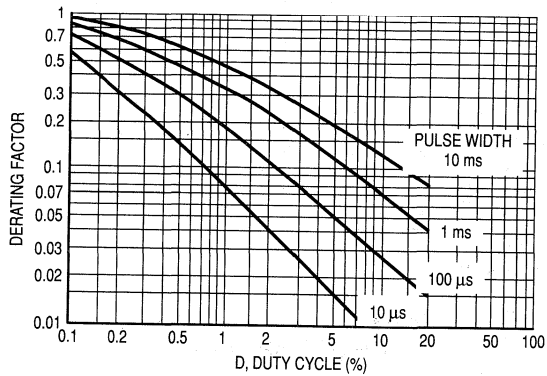

Figure 6. Typical Derating Factor for Duty Cycle

4

4.1

1SMB5.0AT3 thru 1SMB170AT3

ELECTRICAL CHARACTERISTICS (T _A = 25°C unless otherwise noted).							
Device† ‡	Reverse Stand-Off Voltage V _R Volts (1)	Breakdown Voltage*		Maximum Clamping Voltage V _C @ I _{pp} Volts	Peak Pulse Current (See Figure 2) I _{pp} † Amps	Maximum Reverse Leakage @ V _R I _R µA	Device Marking
		V _{BR} @ I _T					
		Volts Min	mA				
1SMB5.0AT3	5.0	6.40	10	9.2	65.2	800	KE
1SMB6.0AT3	6.0	6.67	10	10.3	58.3	800	KG
1SMB6.5AT3	6.5	7.22	10	11.2	53.6	500	KK
1SMB7.0AT3	7.0	7.78	10	12.0	50.0	200	KM
1SMB7.5AT3	7.5	8.33	1.0	12.9	46.5	100	KP
1SMB8.0AT3	8.0	8.89	1.0	13.6	44.1	50	KR
1SMB8.5AT3	8.5	9.44	1.0	14.4	41.7	10	KT
1SMB9.0AT3	9.0	10.0	1.0	15.4	39.0	5.0	KV
1SMB10AT3	10	11.1	1.0	17.0	35.3	5.0	KX
1SMB11AT3	11	12.2	1.0	18.2	33.0	5.0	KZ
1SMB12AT3	12	13.3	1.0	19.9	30.2	5.0	LE
1SMB13AT3	13	14.4	1.0	21.5	27.9	5.0	LG
1SMB14AT3	14	15.6	1.0	23.2	25.8	5.0	LK
1SMB15AT3	15	16.7	1.0	24.4	24.0	5.0	LM
1SMB16AT3	16	17.8	1.0	26.0	23.1	5.0	LP
1SMB17AT3	17	18.9	1.0	27.6	21.7	5.0	LR
1SMB18AT3	18	20.0	1.0	29.2	20.5	5.0	LT
1SMB20AT3	20	22.2	1.0	32.4	18.5	5.0	LV
1SMB22AT3	22	24.4	1.0	35.5	16.9	5.0	LX
1SMB24AT3	24	26.7	1.0	38.9	15.4	5.0	LZ
1SMB26AT3	26	28.9	1.0	42.1	14.2	5.0	ME
1SMB28AT3	28	31.1	1.0	45.4	13.2	5.0	MG
1SMB30AT3	30	33.3	1.0	48.4	12.4	5.0	MK
1SMB33AT3	33	36.7	1.0	53.3	11.3	5.0	MM
1SMB36AT3	36	40.0	1.0	58.1	10.3	5.0	MP
1SMB40AT3	40	44.4	1.0	64.5	9.3	5.0	MR
1SMB43AT3	43	47.8	1.0	69.4	8.6	5.0	MT
1SMB45AT3	45	50.0	1.0	72.7	8.3	5.0	MV
1SMB48AT3	48	53.3	1.0	77.4	7.7	5.0	MX
1SMB51AT3	51	56.7	1.0	82.4	7.3	5.0	MZ
1SMB54AT3	54	60.0	1.0	87.1	6.9	5.0	NE
1SMB58AT3	58	64.4	1.0	93.6	6.4	5.0	NG
1SMB60AT3	60	66.7	1.0	96.8	6.2	5.0	NK
1SMB64AT3	64	71.1	1.0	103	5.8	5.0	NM
1SMB70AT3	70	77.8	1.0	113	5.3	5.0	NP
1SMB75AT3	75	83.3	1.0	121	4.9	5.0	NR
1SMB78AT3	78	86.7	1.0	126	4.7	5.0	NT
1SMB85AT3	85	94.4	1.0	137	4.4	5.0	NV
1SMB90AT3	90	100	1.0	146	4.1	5.0	NX
1SMB100AT3	100	111	1.0	162	3.7	5.0	NZ
1SMB110AT3	110	122	1.0	177	3.4	5.0	PE
1SMB120AT3	120	133	1.0	193	3.1	5.0	PG
1SMB130AT3	130	144	1.0	209	2.9	5.0	PK
1SMB150AT3	150	167	1.0	243	2.5	5.0	PM
1SMB160AT3	160	178	1.0	259	2.3	5.0	PP
1SMB170AT3	170	189	1.0	275	2.2	5.0	PR

Note 1: A transient suppressor is normally selected according to the reverse "Stand Off Voltage" (V_R) which should be equal to or greater than the DC or continuous peak operating voltage level.

* V_{BR} measured at pulse test current I_T at an ambient temperature of 25°C.

† Surge current waveform per Figure 2 and derate per Figure 3 of the General Data — 600 Watt at the beginning of this group.

‡ † T3 suffix designates tape and reel of 2500 units.

ABBREVIATIONS AND SYMBOLS

V_R Stand Off Voltage. Applied reverse voltage to assure a non-conductive condition (See Note 1).

V_{(BR)min} This is the minimum breakdown voltage the device will exhibit and is used to assure that conduction does not occur prior to this voltage level at 25°C.

V_C Maximum Clamping Voltage. The maximum peak voltage appearing across the transient suppressor when

I_{pp}
P_P
I_R

subjected to the peak pulse current in a one millisecond time interval. The peak pulse voltages are the combination of voltage rise due to both the series resistance and thermal rise.

Peak Pulse Current — See Figure 2

Peak Pulse Power

Reverse Leakage

P6SMB6.8AT3 thru P6SMB200AT3

ELECTRICAL CHARACTERISTICS ($T_A = 25^\circ\text{C}$ unless otherwise noted) $V_F = 3.5\text{ V Max}$, $I_F^{**} = 50\text{ A}$ for all types.

Device† †	Breakdown Voltage*				Working Peak Reverse Voltage V_{RWM} Volts	Maximum Reverse Leakage @ V_{RWM} I_R μA	Maximum Reverse Surge Current I_{RSM}^\dagger Amps	Maximum Reverse Voltage @ I_{RSM} (Clamping Voltage) V_{RSM} Volts	Maximum Temperature Coefficient of V_{BR} $\%/^\circ\text{C}$	Device Marking
	V_{BR} @ I_T Volts									
	Min	Nom	Max	mA						
P6SMB6.8AT3	6.45	6.8	7.14	10	5.8	1000	57	10.5	0.057	6V8A
P6SMB7.5AT3	7.13	7.5	7.88	10	6.4	500	53	11.3	0.061	7V5A
P6SMB8.2AT3	7.79	8.2	8.61	10	7.02	200	50	12.1	0.065	8V2A
P6SMB9.1AT3	8.65	9.1	9.55	1	7.78	50	45	13.4	0.068	9V1A
P6SMB10AT3	9.5	10	10.5	1	8.55	10	41	14.5	0.073	10A
P6SMB11AT3	10.5	11	11.6	1	9.4	5	38	15.6	0.075	11A
P6SMB12AT3	11.4	12	12.6	1	10.2	5	36	16.7	0.078	12A
⇒ P6SMB13AT3	12.4	13	13.7	1	11.1	5	33	18.2	0.081	13A
⇒ P6SMB15AT3	14.3	15	15.8	1	12.8	5	28	21.2	0.084	15A
P6SMB16AT3	15.2	16	16.8	1	13.6	5	27	22.5	0.086	16A
P6SMB18AT3	17.1	18	18.9	1	15.3	5	24	25.2	0.088	18A
P6SMB20AT3	19	20	21	1	17.1	5	22	27.7	0.09	20A
P6SMB22AT3	20.9	22	23.1	1	18.8	5	20	30.6	0.092	22A
P6SMB24AT3	22.8	24	25.2	1	20.5	5	18	33.2	0.094	24A
⇒ P6SMB27AT3	25.7	27	28.4	1	23.1	5	16	37.5	0.096	27A
⇒ P6SMB30AT3	28.5	30	31.5	1	25.6	5	14.4	41.4	0.097	30A
⇒ P6SMB33AT3	31.4	33	34.7	1	28.2	5	13.2	45.7	0.098	33A
⇒ P6SMB36AT3	34.2	36	37.8	1	30.8	5	12	49.9	0.099	36A
P6SMB39AT3	37.1	39	41	1	33.3	5	11.2	53.9	0.1	39A
P6SMB43AT3	40.9	43	45.2	1	36.8	5	10.1	59.3	0.101	43A
P6SMB47AT3	44.7	47	49.4	1	40.2	5	9.3	64.8	0.101	47A
⇒ P6SMB51AT3	48.5	51	53.6	1	43.6	5	8.6	70.1	0.102	51A
P6SMB56AT3	53.2	56	58.8	1	47.8	5	7.8	77	0.103	56A
⇒ P6SMB62AT3	58.9	62	65.1	1	53	5	7.1	85	0.104	62A
P6SMB68AT3	64.6	68	71.4	1	58.1	5	6.5	92	0.104	68A
P6SMB75AT3	71.3	75	78.8	1	64.1	5	5.8	103	0.105	75A
P6SMB82AT3	77.9	82	86.1	1	70.1	5	5.3	113	0.105	82A
P6SMB91AT3	86.5	91	95.5	1	77.8	5	4.8	125	0.106	91A
P6SMB100AT3	95	100	105	1	85.5	5	4.4	137	0.106	100A
P6SMB110AT3	105	110	116	1	94	5	4	152	0.107	110A
P6SMB120AT3	114	120	126	1	102	5	3.6	165	0.107	120A
P6SMB130AT3	124	130	137	1	111	5	3.3	179	0.107	130A
P6SMB150AT3	143	150	158	1	128	5	2.9	207	0.108	150A
P6SMB160AT3	152	160	168	1	136	5	2.7	219	0.108	160A
P6SMB170AT3	162	170	179	1	145	5	2.6	234	0.108	170A
P6SMB180AT3	171	180	189	1	154	5	2.4	246	0.108	180A
P6SMB200AT3	190	200	210	1	171	5	2.2	274	0.108	200A

⇒ Preferred part

* V_{BR} measured at pulse test current I_T at an ambient temperature of 25°C .
† 1/2 sine wave (or equivalent square wave), $PW = 8.3\text{ ms}$, duty cycle = 4 pulses per minute maximum.
† † Surge current waveform per Figure 2 and derate per Figure 3 of the General Data — 600 Watt at the beginning of this group.
† † T3 suffix designates tape and reel of 2500 units.

SECTION 4.1.4 DATA SHEETS
TRANSIENT VOLTAGE SUPPRESSORS — continued

Section 4.1.4.2 Surface Mounted — continued

SECTION 4.1.4.2.3 1500 WATT PEAK POWER

DATA SHEETS

Devices	Page No.
General Data — 1500 Watt	4-1-62
1SMC5.0AT3 thru 1SMC78AT3	4-1-65
1.5SMC6.8AT3 thru 1.5SMC91AT3	4-1-66

MULTIPLE PACKAGE QUANTITY (MPQ)
REQUIREMENTS

Package Option	Type No. Suffix	MPQ (Units)
Tape and Reel	T3 ⁽¹⁾	2.5K

NOTE 1. The "3" on the suffix designates reel size (13") and full reel quantity of 2.5K.

4

4.1

GENERAL DATA APPLICABLE TO ALL SERIES IN THIS GROUP
Zener Transient Voltage Suppressors

GENERAL DATA
1500 WATT PEAK POWER

The SMC series is designed to protect voltage sensitive components from high voltage, high energy transients. They have excellent clamping capability, high surge capability, low zener impedance and fast response time. The SMC series is supplied in Motorola's exclusive, cost-effective, highly reliable Surmetic package and is ideally suited for use in communication systems, numerical controls, process controls, medical equipment, business machines, power supplies and many other industrial/consumer applications.

Specification Features:

- Standard Zener Breakdown Voltage Range — 6.8 to 91 V
- Stand-off Voltage Range — 5 to 78 V
- Peak Power — 1500 Watts @ 1 ms
- Maximum Clamp Voltage @ Peak Pulse Current
- Low Leakage < 5 μ A Above 10 V
- Maximum Temperature Coefficient Specified
- Available in Tape and Reel

Mechanical Characteristics:

CASE: Void-free, transfer-molded, thermosetting plastic

FINISH: All external surfaces are corrosion resistant and leads are readily solderable

POLARITY: Cathode indicated by molded polarity notch. When operated in zener mode, will be positive with respect to anode

MOUNTING POSITION: Any

LEADS: Modified L-Bend providing more contact area to bond pads

MAXIMUM CASE TEMPERATURE FOR SOLDERING PURPOSES: 230°C for 10 seconds

PLASTIC SURFACE MOUNT ZENER OVERVOLTAGE TRANSIENT SUPPRESSORS
6.8-91 VOLT
1500 WATT PEAK POWER

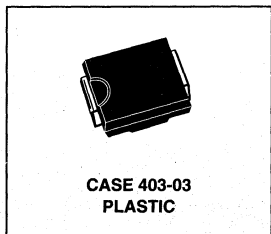

4

4.1

MAXIMUM RATINGS				
	Rating	Symbol	Value	Unit
Peak Power Dissipation (1)	@ $T_L \leq 25^\circ\text{C}$	PPK	1500	Watts
Forward Surge Current (2)	@ $T_A = 25^\circ\text{C}$	I _{FSM}	200	Amps
Operating and Storage Temperature Range		T _J , T _{stg}	-65 to +175	°C

NOTES: 1. Nonrepetitive current pulse per Figure 2 and derated above $T_A = 25^\circ\text{C}$ per Figure 3.
 2. 1/2 sine wave (or equivalent square wave), PW = 8.3 ms, duty cycle = 4 pulses per minute maximum.

GENERAL DATA — 1500 WATT PEAK POWER

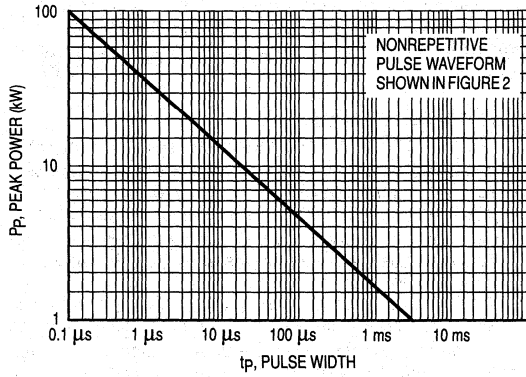

Figure 1. Pulse Rating Curve

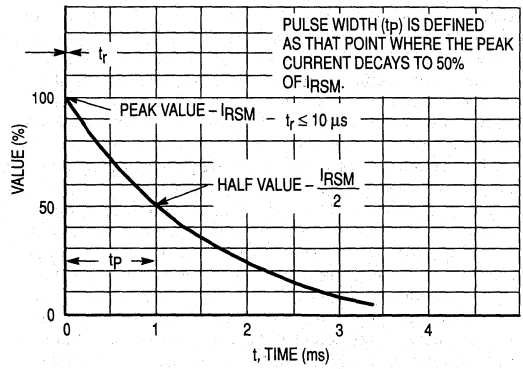

Figure 2. Pulse Waveform

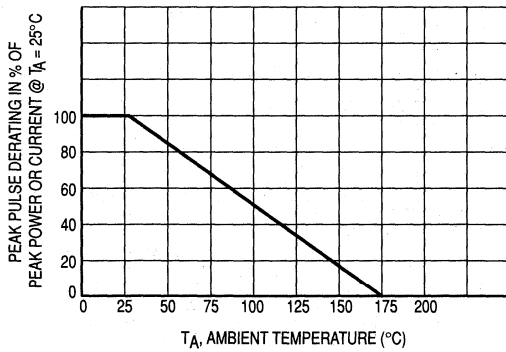

Figure 3. Pulse Derating Curve

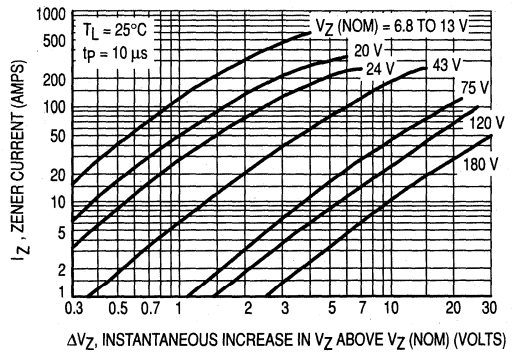

Figure 4. Dynamic Impedance

4

4.1

GENERAL DATA — 1500 WATT PEAK POWER

APPLICATION NOTES

RESPONSE TIME

In most applications, the transient suppressor device is placed in parallel with the equipment or component to be protected. In this situation, there is a time delay associated with the capacitance of the device and an overshoot condition associated with the inductance of the device and the inductance of the connection method. The capacitive effect is of minor importance in the parallel protection scheme because it only produces a time delay in the transition from the operating voltage to the clamp voltage as shown in Figure 5.

The inductive effects in the device are due to actual turn-on time (time required for the device to go from zero current to full current) and lead inductance. This inductive effect produces an overshoot in the voltage across the equipment or component being protected as shown in Figure 6. Minimizing this overshoot is very important in the application, since the main purpose for adding a transient suppressor is to clamp voltage spikes. The SMC series have a very good response time, typically < 1 ns and negligible inductance. However, external inductive effects could produce unacceptable overshoot. Proper circuit layout, minimum lead lengths and placing the

suppressor device as close as possible to the equipment or components to be protected will minimize this overshoot.

Some input impedance represented by Z_{in} is essential to prevent overstress of the protection device. This impedance should be as high as possible, without restricting the circuit operation.

DUTY CYCLE DERATING

The data of Figure 1 applies for non-repetitive conditions and at a lead temperature of 25°C. If the duty cycle increases, the peak power must be reduced as indicated by the curves of Figure 7. Average power must be derated as the lead or ambient temperature rises above 25°C. The average power derating curve normally given on data sheets may be normalized and used for this purpose.

At first glance the derating curves of Figure 7 appear to be in error as the 10 ms pulse has a higher derating factor than the 10 μs pulse. However, when the derating factor for a given pulse of Figure 7 is multiplied by the peak power value of Figure 1 for the same pulse, the results follow the expected trend.

TYPICAL PROTECTION CIRCUIT

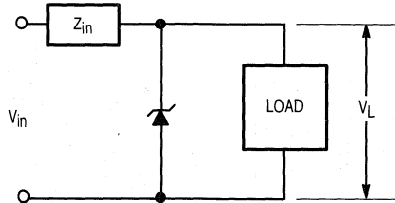

4

4.1

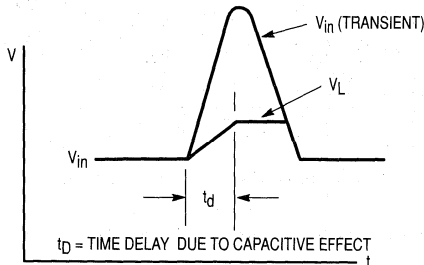

Figure 5.

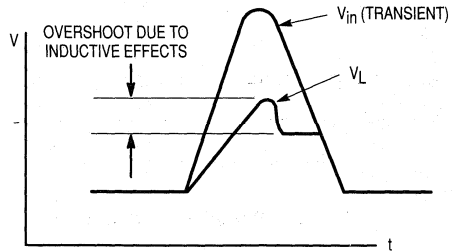

Figure 6.

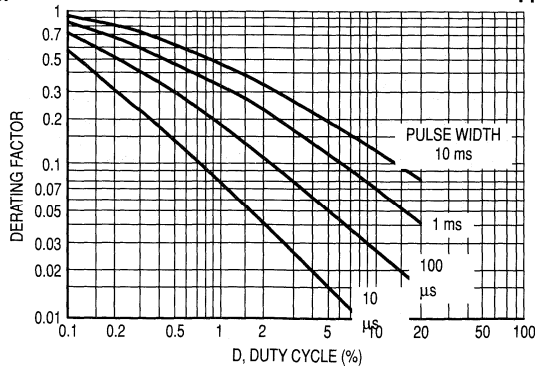

Figure 7. Typical Derating Factor for Duty Cycle

1SMC5.0AT3 thru 1SMC78AT3

ELECTRICAL CHARACTERISTICS (T _A = 25°C unless otherwise noted).							
Device† ‡	Reverse Stand-Off Voltage V _R Volts (1)	Breakdown Voltage*		Maximum Clamping Voltage V _C @ I _{pp} Volts	Peak Pulse Current (See Figure 2) I _{pp} † Amps	Maximum Reverse Leakage @ V _R I _R μA	Device Marking
		V _{BR} @ I _T Volts Min	mA				
1SMC5.0AT3	5.0	6.40	10	9.2	163.0	1000	GDE
1SMC6.0AT3	6.0	6.67	10	10.3	145.6	1000	GDG
1SMC6.5AT3	6.5	7.22	10	11.2	133.9	500	GDK
1SMC7.0AT3	7.0	7.78	10	12.0	125.0	200	GDM
1SMC7.5AT3	7.5	8.33	1.0	12.9	116.3	100	GDP
1SMC8.0AT3	8.0	8.89	1.0	13.6	110.3	50	GDR
1SMC8.5AT3	8.5	9.44	1.0	14.4	104.2	20	GDT
1SMC9.0AT3	9.0	10.0	1.0	15.4	97.4	10	GDV
1SMC10AT3	10	11.1	1.0	17.0	88.2	5.0	GDX
1SMC11AT3	11	12.2	1.0	18.2	82.4	5.0	GDZ
1SMC12AT3	12	13.3	1.0	19.9	75.3	5.0	GEE
1SMC13AT3	13	14.4	1.0	21.5	69.7	5.0	GEG
1SMC14AT3	14	15.6	1.0	23.2	64.7	5.0	GEK
1SMC15AT3	15	16.7	1.0	24.4	61.5	5.0	GEM
1SMC16AT3	16	17.8	1.0	26.0	57.7	5.0	GEP
1SMC17AT3	17	18.9	1.0	27.6	53.3	5.0	GER
1SMC18AT3	18	20.0	1.0	29.2	51.4	5.0	GET
1SMC20AT3	20	22.2	1.0	32.4	46.3	5.0	GEV
1SMC22AT3	22	24.4	1.0	35.5	42.2	5.0	GEX
1SMC24AT3	24	26.7	1.0	38.9	38.6	5.0	GEZ
1SMC26AT3	26	28.9	1.0	42.1	35.6	5.0	GFE
1SMC28AT3	28	31.1	1.0	45.4	33.0	5.0	GFG
1SMC30AT3	30	33.3	1.0	48.4	31.0	5.0	GFK
1SMC33AT3	33	36.7	1.0	53.3	28.1	5.0	GFM
1SMC36AT3	36	40.0	1.0	58.1	25.8	5.0	GFP
1SMC40AT3	40	44.4	1.0	64.5	23.2	5.0	GFR
1SMC43AT3	43	47.8	1.0	69.4	21.6	5.0	GFT
1SMC45AT3	45	50.0	1.0	72.7	20.6	5.0	GFV
1SMC48AT3	48	53.3	1.0	77.4	19.4	5.0	GFX
1SMC51AT3	51	56.7	1.0	82.4	18.2	5.0	GFZ
1SMC54AT3	54	60.0	1.0	87.1	17.2	5.0	GGE
1SMC58AT3	58	64.4	1.0	93.6	16.0	5.0	GGG
1SMC60AT3	60	66.7	1.0	96.8	15.5	5.0	GGK
1SMC64AT3	64	71.1	1.0	103	14.6	5.0	GGM
1SMC70AT3	70	77.8	1.0	113	13.3	5.0	GGP
1SMC75AT3	75	83.3	1.0	121	12.4	5.0	GGR
1SMC78AT3	78	86.7	1.0	126	11.4	5.0	GGT

Note 1: A transient suppressor is normally selected according to the reverse "Stand Off Voltage" (V_R) which should be equal to or greater than the DC or continuous peak operating voltage level.

* V_{BR} measured at pulse test current I_T at an ambient temperature of 25°C.

† Surge current waveform per Figure 2 and derate per Figure 3 of the General Data — 1500 Watt at the beginning of this group.

‡ † T3 suffix designates tape and reel of 2500 units.

ABBREVIATIONS AND SYMBOLS

V_R Stand Off Voltage. Applied reverse voltage to assure a non-conductive condition (See Note 1).

V_{(BR)min} This is the minimum breakdown voltage the device will exhibit and is used to assure that conduction does not occur prior to this voltage level at 25°C.

V_C Maximum Clamping Voltage. The maximum peak voltage appearing across the transient suppressor when

subjected to the peak pulse current in a one millisecond time interval. The peak pulse series resistance and thermal rise.

I_{pp} Peak Pulse Current — See Figure 2

P_p Peak Pulse Power

I_R Reverse Leakage



1.5SMC6.8AT3 thru 1.5SMC91AT3

ELECTRICAL CHARACTERISTICS (T _A = 25°C unless otherwise noted) V _F = 3.5 V Max, I _F ** = 100 A for all types.										
Device ††	Breakdown Voltage*				Working Peak Reverse Voltage V _{RWM} Volts	Maximum Reverse Leakage @ V _{RWM} I _R μA	Maximum Reverse Surge Current I _{RSMT} Amps	Maximum Reverse Voltage @ I _{RSM} (Clamping Voltage) V _{RSM} Volts	Maximum Temperature Coefficient of V _{BR} %/°C	Device Marking
	V _{BR} @ I _T Volts									
	Min	Nom	Max	mA						
1.5SMC6.8AT3	6.45	6.8	7.14	10	5.8	1000	143	10.5	0.057	6V8A
1.5SMC7.5AT3	7.13	7.5	7.88	10	6.4	500	132	11.3	0.061	7V5A
1.5SMC8.2AT3	7.79	8.2	8.61	10	7.02	200	124	12.1	0.065	8V2A
1.5SMC9.1AT3	8.65	9.1	9.55	1	7.78	50	112	13.4	0.068	9V1A
1.5SMC10AT3	9.5	10	10.5	1	8.55	10	103	14.5	0.073	10A
1.5SMC11AT3	10.5	11	11.6	1	9.4	5	96	15.6	0.075	11A
1.5SMC12AT3	11.4	12	12.6	1	10.2	5	90	16.7	0.078	12A
1.5SMC13AT3	12.4	13	13.7	1	11.1	5	82	18.2	0.081	13A
1.5SMC15AT3	14.3	15	15.8	1	12.8	5	71	21.2	0.084	15A
1.5SMC16AT3	15.2	16	16.8	1	13.6	5	67	22.5	0.086	16A
1.5SMC18AT3	17.1	18	18.9	1	15.3	5	59.5	25.2	0.088	18A
1.5SMC20AT3	19	20	21	1	17.1	5	54	27.7	0.09	20A
1.5SMC22AT3	20.9	22	23.1	1	18.8	5	49	30.6	0.092	22A
1.5SMC24AT3	22.8	24	25.2	1	20.5	5	45	33.2	0.094	24A
1.5SMC27AT3	25.7	27	28.4	1	23.1	5	40	37.5	0.096	27A
1.5SMC30AT3	28.5	30	31.5	1	25.6	5	36	41.4	0.097	30A
1.5SMC33AT3	31.4	33	34.7	1	28.2	5	33	45.7	0.098	33A
⇒ 1.5SMC36AT3	34.2	36	37.8	1	30.8	5	30	49.9	0.099	36A
1.5SMC39AT3	37.1	39	41	1	33.3	5	28	53.9	0.1	39A
1.5SMC43AT3	40.9	43	45.2	1	36.8	5	25.3	59.3	0.101	43A
1.5SMC47AT3	44.7	47	49.4	1	40.2	5	23.2	64.8	0.101	47A
1.5SMC51AT3	48.5	51	53.6	1	43.6	5	21.4	70.1	0.102	51A
⇒ 1.5SMC56AT3	53.2	56	58.8	1	47.8	5	19.5	77	0.103	56A
⇒ 1.5SMC62AT3	58.9	62	65.1	1	53	5	17.7	85	0.104	62A
1.5SMC68AT3	64.6	68	71.4	1	58.1	5	16.3	92	0.104	68A
1.5SMC75AT3	71.3	75	78.8	1	64.1	5	14.6	103	0.105	75A
1.5SMC82AT3	77.9	82	86.1	1	70.1	5	13.3	113	0.105	82A
1.5SMC91AT3	86.5	91	95.5	1	77.8	5	12	125	0.106	91A

⇒ Preferred part

* V_{BR} measured at pulse test current I_T at an ambient temperature of 25°C.
 ** 1/2 sine wave (or equivalent square wave), PW = 8.3 ms, duty cycle = 4 pulses per minute maximum.
 † Surge current waveform per Figure 2 and derate per Figure 3 of General Data — 1500 Watt at the beginning of this group.
 †† T3 suffix designates tape and reel of 2500 units.

Section 4.2

Zener Voltage Regulator Diodes

Section	Page
4.2.1 Selector Guide	4-2-2
4.2.2 Data Sheet Category Listing	4-2-11
4.2.3 Alphanumeric Part Number Listing ..	4-2-12
4.2.4 Data Sheets	4-2-21

Section 4.2.1 Selector Guide

Zener Voltage Regulator Diodes

4

4.2

SELECTOR GUIDE

Zener Voltage Regulator Diodes

Axial Leaded for Thru-hole Designs (See Section 4.2.4 for complete data)

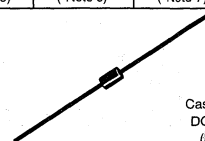
Nominal Zener Breakdown Voltage	500 mW	500 mW Low Level	500 mW					500 mW Low Level	500 mW		
	Cathode = Polarity Band	Cathode = Polarity Band	Cathode = Polarity Band								Cathode = Polarity Band
(*Note 1)	(*Note 2)	(*Note 3)	(*Note 4)	(*Note 5)	(*Note 6)	(*Note 7)	(*Note 8)	(*Note 9)	(*Note 10)	(*Note 8)	
Volts	 <p>Glass Case 299-02 DO-204AH (DO-35)</p>										
1.8		1N4678							MZ4614		
2.0		1N4679							MZ4615		
2.2		1N4680							MZ4616		
2.4	1N4370A	1N4681	1N5221B	1N5985B	BZX55C2V4	BZX79C2V4			MZ4617		
2.5			1N5222B								
2.7	1N4371A	1N4682	1N5223B	1N5986B	BZX55C2V7	BZX79C2V7	BZX83C2V7	MZ4618		ZPD2.7	
2.8			1N5224B								
3.0	1N4372A	1N4683	1N5225B	1N5987B	BZX55C3V0	BZX79C3V0	BZX83C3V0	MZ4619		ZPD3.0	
3.3	1N746A	1N4684	1N5226B	1N5988B	BZX55C3V3	BZX79C3V3	BZX83C3V3	MZ4620		ZPD3.3	
3.6	1N747A	1N4685	1N5227B	1N5989B	BZX55C3V6	BZX79C3V6	BZX83C3V6	MZ4621		ZPD3.6	
3.9	1N748A	1N4686	1N5228B	1N5990B	BZX55C3V9	BZX79C3V9	BZX83C3V9	MZ4622	MZ5520B	ZPD3.9	
4.3	1N749A	1N4687	1N5229B	1N5991B	BZX55C4V3	BZX79C4V3	BZX83C4V3	MZ4623	MZ5521B	ZPD4.3	
4.7	1N750A	1N4688	1N5230B	1N5992B	BZX55C4V7	BZX79C4V7	BZX83C4V7	MZ4624	MZ5522B	ZPD4.7	
5.1	1N751A	1N4689	1N5231B	1N5993B	BZX55C5V1	BZX79C5V1	BZX83C5V1	MZ4625	MZ5523B	ZPD5.1	
5.6	1N752A	1N4690	1N5232B	1N5994B	BZX55C5V6	BZX79C5V6	BZX83C5V6	MZ4626	MZ5524B	ZPD5.6	
6.0			1N5233B								
6.2	1N753A	1N4691	1N5234B	1N5995B	BZX55C6V2	BZX79C6V2	BZX83C6V2	MZ4627	MZ5525B	ZPD6.2	
6.8	1N754A 1N957B	1N4692	1N5235B	1N5996B	BZX55C6V8	BZX79C6V8	BZX83C6V8	MZ4099	MZ5526B	ZPD6.8	
7.5	1N755A 1N958B	1N4693	1N5236B	1N5997B	BZX55C7V5	BZX79C7V5	BZX83C7V5	MZ4100	MZ5527B	ZPD7.5	
8.2	1N756A 1N959B	1N4694	1N5237B	1N5998B	BZX55C8V2	BZX79C8V2	BZX83C8V2	MZ4101	MZ5528B	ZPD8.2	
8.7		1N4695	1N5238B					MZ4102			
9.1	1N757A 1N960B	1N4696	1N5239B	1N5999B	BZX55C9V1	BZX79C9V1	BZX83C9V1	MZ4103	MZ5529B	ZPD9.1	
10	1N758A 1N961B	1N4697	1N5240B	1N6000B	BZX55C10	BZX79C10	BZX83C10	MZ4104	MZ5530B	ZPD10	
11	1N962B	1N4698	1N5241B	1N6001B	BZX55C11	BZX79C11	BZX83C11			ZPD11	
12	1N759A 1N963B	1N4699	1N5242B	1N6002B	BZX55C12	BZX79C12	BZX83C12			ZPD12	
13	1N964B	1N4700	1N5243B	1N6003B	BZX55C13	BZX79C13	BZX83C13			ZPD13	
14		1N4701	1N5244B								
15	1N965B	1N4702	1N5245B	1N6004B	BZX55C15	BZX79C15	BZX83C15			ZPD15	
16	1N966B	1N4703	1N5246B	1N6005B	BZX55C16	BZX79C16	BZX83C16			ZPD16	
17		1N4704	1N5247B								
18	1N967B	1N4705	1N5248B	1N6006B	BZX55C18	BZX79C18	BZX83C18			ZPD18	
19		1N4706	1N5249B								
20	1N968B	1N4707	1N5250B	1N6007B	BZX55C20	BZX79C20	BZX83C20			ZPD20	
22	1N969B	1N4708	1N5251B	1N6008B	BZX55C22	BZX79C22	BZX83C22			ZPD22	
24	1N970B	1N4709	1N5252B	1N6009B	BZX55C24	BZX79C24	BZX83C24			ZPD24	
25		1N4710	1N5253B								
27	1N971B	1N4711	1N5254B	1N6010B	BZX55C27	BZX79C27	BZX83C27			ZPD27	
28		1N4712	1N5255B								
30	1N972B	1N4713	1N5256B	1N6011B	BZX55C30	BZX79C30	BZX83C30			ZPD30	
33	1N973B	1N4714	1N5257B	1N6012B	BZX55C33	BZX79C33	BZX83C33			ZPD33	
36	1N974B	1N4715	1N5258B	1N6013B	BZX55C36	BZX79C36	BZX83C36				
39	1N975B	1N4716	1N5259B	1N6014B	BZX55C39	BZX79C39	BZX83C39				
43	1N976B	1N4717	1N5260B	1N6015B	BZX55C43	BZX79C43	BZX83C43				
47	1N977B		1N5261B	1N6016B	BZX55C47	BZX79C47					
51	1N978B		1N5262B	1N6017B	BZX55C51	BZX79C51					
56	1N979B		1N5263B	1N6018B	BZX55C56	BZX79C56					
60			1N5264B								
62	1N980B		1N5265B	1N6019B	BZX55C62	BZX79C62					
68	1N981B		1N5266B	1N6020B	BZX55C68	BZX79C68					

*See Notes — page 4-2-7



SELECTOR GUIDE

Axial Leaded for Thru-hole Designs (continued) (See Section 4.2.4 for complete data)

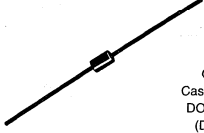
Nominal Zener Breakdown Voltage	500 mW	500 mW Low Level	500 mW				500 mW Low Level	500 mW		
	Cathode = Polarity Band	Cathode = Polarity Band	Cathode = Polarity Band				Cathode = Polarity Band	Cathode = Polarity Band		
(*Note 1)	(*Note 2)	(*Note 3)	(*Note 4)	(*Note 5)	(*Note 6)	(*Note 7)	(*Note 8)	(*Note 9)	(*Note 10)	(*Note 8)
Volts	 <p>Glass Case 299-02 DO-204AH (DO-35)</p>									
75	1N982B		1N5267B	1N6021B	BZX55C75	BZX79C75				
82	1N983B		1N5268B	1N6022B	BZX55C82	BZX79C82				
87			1N5269B							
91	1N984B		1N5270B	1N6023B	BZX55C91	BZX79C91				
100	1N985B		1N5271B	1N6024B		BZX79C100				
110	1N986B		1N5272B	1N6025B		BZX79C110				
120	1N987B		1N5273B			BZX79C120				
130	1N988B		1N5274B			BZX79C130				
140			1N5275B							
150	1N989B		1N5276B			BZX79C150				
160	1N990B		1N5277B			BZX79C160				
170			1N5278B							
180	1N991B		1N5279B			BZX79C180				
190			1N5280B							
200	1N992B		1N5281B			BZX79C200				
220										
240										
270										
300										
330										
360										
400										



*See Notes — page 4-2-7

4

4.2

SELECTOR GUIDE

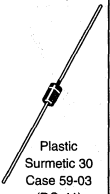
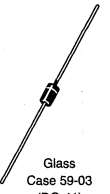
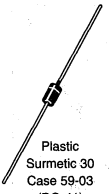
Axial Leaded for Thru-hole Designs (continued) (See Section 4.2.4 for complete data)

Nominal Zener Breakdown Voltage	1 Watt		1.3 Watt			1.5 Watt	3 Watt	5 Watt
	Cathode = Polarity Band		Cathode = Polarity Band			Cathode = Polarity Band	Cathode = Polarity Band	Cathode = Polarity Band
(*Note 1)	(*Note 11)	(*Note 12)	(*Note 13)	(*Note 14)	(*Note 15)	(*Note 16)	(*Note 17)	(*Note 18)
Volts								
1.8								
2.0								
2.2								
2.4								
2.5								
2.7								
2.8								
3.0								
3.3	1N4728A	MZP4728A	BZX85C3V3			1N5913B		1N5333B
3.6	1N4729A	MZP4729A	BZX85C3V6			1N5914B		1N5334B
3.9	1N4730A	MZP4730A	BZX85C3V9	MZPY3.9	MZD3.9	1N5915B	3EZ3.9D5	1N5335B
4.3	1N4731A	MZP4731A	BZX85C4V3	MZPY4.3	MZD4.3	1N5916B	3EZ4.3D5	1N5336B
4.7	1N4732A	MZP4732A	BZX85C4V7	MZPY4.7	MZD4.7	1N5917B	3EZ4.7D5	1N5337B
5.1	1N4733A	MZP4733A	BZX85C5V1	MZPY5.1	MZD5.1	1N5918B	3EZ5.1D5	1N5338B
5.6	1N4734A	MZP4734A	BZX85C5V6	MZPY5.6	MZD5.6	1N5919B	3EZ5.6D5	1N5339B
6.0								1N5340B
6.2	1N4735A	MZP4735A	BZX85C6V2	MZPY6.2	MZD6.2	1N5920B	3EZ6.2D5	1N5341B
6.8	1N4736A	MZP4736A	BZX85C6V8	MZPY6.8	MZD6.8	1N5921B	3EZ6.8D5	1N5342B
7.5	1N4737A	MZP4737A	BZX85C7V5	MZPY7.5	MZD7.5	1N5922B	3EZ7.5D5	1N5343B
8.2	1N4738A	MZP4738A	BZX85C8V2	MZPY8.2	MZD8.2	1N5923B	3EZ8.2D5	1N5344B
8.7								1N5345B
9.1	1N4739A	MZP4739A	BZX85C9V1	MZPY9.1	MZD9.1	1N5924B	3EZ9.1D5	1N5346B
10	1N4740A	MZP4740A	BZX85C10	MZPY10	MZD10	1N5925B	3EZ10D5	1N5347B
11	1N4741A	MZP4741A	BZX85C11	MZPY11	MZD11	1N5926B	3EZ11D5	1N5348B
12	1N4742A	MZP4742A	BZX85C12	MZPY12	MZD12	1N5927B	3EZ12D5	1N5349B
13	1N4743A	MZP4743A	BZX85C13	MZPY13	MZD13	1N5928B	3EZ13D5	1N5350B
14							3EZ14D5	1N5351B
15	1N4744A	MZP4744A	BZX85C15	MZPY15	MZD15	1N5929B	3EZ15D5	1N5352B
16	1N4745A	MZP4745A	BZX85C16	MZPY16	MZD16	1N5930B	3EZ16D5	1N5353B
17							3EZ17D5	1N5354B
18	1N4746A	MZP4746A	BZX85C18	MZPY18	MZD18	1N5931B	3EZ18D5	1N5355B
19							3EZ19D5	1N5356B
20	1N4747A	MZP4747A	BZX85C20	MZPY20	MZD20	1N5932B	3EZ20D5	1N5357B
22	1N4748A	MZP4748A	BZX85C22	MZPY22	MZD22	1N5933B	3EZ22D5	1N5358B
24	1N4749A	MZP4749A	BZX85C24	MZPY24	MZD24	1N5934B	3EZ24D5	1N5359B
25								1N5360B
27	1N4750A	MZP4750A	BZX85C27	MZPY27	MZD27	1N5935B	3EZ27D5	1N5361B
28							3EZ28D5	1N5362B
30	1N4751A	MZP4751A	BZX85C30	MZPY30	MZD30	1N5936B	3EZ30D5	1N5363B
33	1N4752A	MZP4752A	BZX85C33	MZPY33	MZD33	1N5937B	3EZ33D5	1N5364B
36	1N4753A	MZP4753A	BZX85C36	MZPY36	MZD36	1N5938B	3EZ36D5	1N5365B
39	1N4754A	MZP4754A	BZX85C39	MZPY39	MZD39	1N5939B	3EZ39D5	1N5366B
43	1N4755A	MZP4755A	BZX85C43	MZPY43	MZD43	1N5940B	3EZ43D5	1N5367B
47	1N4756A	MZP4756A	BZX85C47	MZPY47	MZD47	1N5941B	3EZ47D5	1N5368B
51	1N4757A	MZP4757A	BZX85C51	MZPY51	MZD51	1N5942B	3EZ51D5	1N5369B
56	1N4758A	MZP4758A	BZX85C56	MZPY56	MZD56	1N5943B	3EZ56D5	1N5370B
60								1N5371B
62	1N4759A	MZP4759A	BZX85C62	MZPY62	MZD62	1N5944B	3EZ62D5	1N5372B
68	1N4760A	MZP4760A	BZX85C68	MZPY68	MZD68	1N5945B	3EZ68D5	1N5373B





*See Notes — page 4-2-7

4

4.2

SELECTOR GUIDE

Axial Leaded for Thru-hole Designs (continued) (See Section 4.2.4 for complete data)

Nominal Zener Breakdown Voltage	1 Watt		1.3 Watt			1.5 Watt	3 Watt	5 Watt
	Cathode = Polarity Band		Cathode = Polarity Band			Cathode = Polarity Band	Cathode = Polarity Band	Cathode = Polarity Band
(*Note 1)	(*Note 11)	(*Note 12)	(*Note 13)	(*Note 14)	(*Note 15)	(*Note 16)	(*Note 17)	(*Note 18)
Volts								
	Glass Case 59-03 (DO-41)	Plastic Surmetic 30 Case 59-03 (DO-41)	Glass Case 59-03 (DO-41)			Plastic Surmetic 30 Case 59-03 (DO-41)		Plastic Surmetic 40 Case 17-02
75	1N4761A	MZP4761A	BZX85C75	MZPY75	MZD75	1N5946B	3EZ75D5	1N5374B
82	1N4762A	MZP4762A	BZX85C82	MZPY82	MZD82	1N5947B	3EZ82D5	1N5375B
87								1N5376B
91	1N4763A	MZP4763A	BZX85C91	MZPY91	MZD91	1N5948B	3EZ91D5	1N5377B
100	1N4764A	MZP4764A	BZX85C100	MZPY100	MZD100	1N5949B	3EZ100D5	1N5378B
110		1M110ZS5			MZD110	1N5950B	3EZ110D5	1N5379B
120		1M120ZS5			MZD120	1N5951B	3EZ120D5	1N5380B
130		1M130ZS5			MZD130	1N5952B	3EZ130D5	1N5381B
140							3EZ140D5	1N5382B
150		1M150ZS5			MZD150	1N5953B	3EZ150D5	1N5383B
160		1M160ZS5			MZD160	1N5954B	3EZ160D5	1N5384B
170							3EZ170D5	1N5385B
180		1M180ZS5			MZD180	1N5955B	3EZ180D5	1N5386B
190							3EZ190D5	1N5387B
200		1M200ZS5			MZD200	1N5956B	3EZ200D5	1N5388B
220							3EZ220D5	
240							3EZ240D5	
270							3EZ270D5	
300							3EZ300D5	
330							3EZ330D5	
360							3EZ360D5	
400							3EZ400D5	

*See Notes — page 4-2-7

4

4.2

SELECTOR GUIDE

(See Section 4.2.4 for complete data)

NOTES — AXIAL LEADED CHART

1. **Zener Voltage** is the key parameter for each device type. It is specified at a particular test current applied at either thermal equilibrium (T.E.) or pulse test condition. The voltage tolerance for the device types listed is, in general $\pm 5\%$; however, for some series, the voltage tolerance varies from device type to device type over a range of (5 to 8.5)%. Consult the complete data sheet to determine the exact test conditions and minimum/maximum limits for the zener voltage. Consult Application Note AN924 regarding measurement of Zener Voltage (pulse versus thermal equilibrium). Also see Section 7 article.

Power Ratings represent the capability of the case size listed as supplied by Motorola. These ratings may be higher than the JEDEC registration and/or the same device types supplied by other manufacturers.

V_Z TEST CONDITIONS AND TOLERANCES

2. **1N4370A/1N746A Series**
I_{ZT} = 20 mA (T.E.).

- No suffix = $\pm 10\%$.
- A suffix = $\pm 5\%$.
- C suffix = $\pm 2\%$.
- D suffix = $\pm 1\%$.

1N957B Series

I_{ZT} @ approximately 125 mW point (T.E.).

- A suffix = $\pm 10\%$.
- B suffix = $\pm 5\%$.
- C suffix = $\pm 2\%$.
- D suffix = $\pm 1\%$.

3. **1N4678 Series** I_{ZT} = 50 μ A (T.E.).

- No suffix = $\pm 5\%$.
 - C suffix = $\pm 2\%$.
 - D suffix = $\pm 1\%$.
- Also has delta V_Z parameter and limit.

4. **1N5221B-42B** I_{ZT} = 20 mA (T.E.).
1N5243B-81B I_{ZT} @ approximately 125 mW point (T.E.).

- A suffix = $\pm 10\%$.
- B suffix = $\pm 5\%$.
- C suffix = $\pm 2\%$.
- D suffix = $\pm 1\%$.

5. **1N5985B-6013B** I_{ZT} = 5 mA (T.E.).
1N6014B-23B I_{ZT} = 2 mA (T.E.).
1N6024B-25B I_{ZT} = 1 mA (T.E.).

- A suffix = $\pm 10\%$.
- B suffix = $\pm 5\%$.
- C suffix = $\pm 2\%$.
- D suffix = $\pm 1\%$.

6. **BZX55C2V4-C36** I_{ZT} = 5 mA (T.E.).
BZX55C39-C82 I_{ZT} = 2.5 mA (T.E.).
BZX55C91 I_{ZT} = 1 mA (T.E.).

C indicates $\pm(5$ to 8.5)% depending on type number.
Replace C with B for $\pm 2\%$.

7. **BZX79C2V4-C24** I_{ZT} = 5 mA (pulse).
BZX79C27-C91 I_{ZT} = 2 mA (pulse).
BZX79C100-C200 I_{ZT} = 1 mA (pulse).

C indicates $\pm(5$ to 8.5)% depending on type number.
Replace C with B for $\pm 2\%$.
Replace C with A for $\pm 1\%$.

8. **BZX83C2V7-C33** I_{ZT} = 5 mA (pulse).
ZPD2.7-33 I_{ZT} = 5 mA (pulse).

Tolerance is $\pm(5$ to 8.5)% depending on type number.

9. **MZ4614-27** I_{ZT} = 250 μ A (T.E.).
MZ4099-4104 I_{ZT} = 250 μ A (T.E.).

Tolerance is $\pm 5\%$.

10. **MZ5520B-21B** I_{ZT} = 20 mA (T.E.).
MZ5522B I_{ZT} = 10 mA (T.E.).
MZ5523B I_{ZT} = 5 mA (T.E.).
MZ5524B I_{ZT} = 3 mA (T.E.).
MZ5525B-30B I_{ZT} = 1 mA (T.E.).

Tolerance is $\pm 5\%$.
Also has delta V_Z parameter and limit.

11. **1N4728A-64A**

I_{ZT} @ approximately 250 mW point (T.E.).

- No suffix = $\pm 10\%$.
- A suffix = $\pm 5\%$.
- C suffix = $\pm 2\%$.
- D suffix = $\pm 1\%$.

12. **MZP4728A-64A**

1M110ZS5-200ZS5

I_{ZT} @ approximately 250 mW point (T.E.).

- MZP Series non suffix = $\pm 10\%$.
- MZP Series A suffix = $\pm 5\%$.
- 1M Series 10 suffix = $\pm 10\%$.
- 1M Series 5 suffix = $\pm 5\%$.

13. **BZX85C3V3-C100**

I_{ZT} varies from 185 mW to 300 mW point depending on type number (pulse).

C indicates $\pm(5$ to 8.5)% depending on type number.

Replace C with B for $\pm 2\%$.

14. **MZPY3.9-8.2** I_{ZT} = 100 mA (pulse).
MZPY9.1-15 I_{ZT} = 50 mA (pulse).
MZPY16-33 I_{ZT} = 25 mA (pulse).
MZPY36-82 I_{ZT} = 10 mA (pulse).
MZPY91-100 I_{ZT} = 5 mA (pulse).

No suffix tolerance is approximately $\pm(5$ to 8.5)% depending on type number.

- C suffix = $\pm 2\%$.
- D suffix = $\pm 1\%$.

15. **MZD3.9-8.2** I_{ZT} = 100 mA (pulse).

MZD9.1-15 I_{ZT} = 50 mA (pulse).
MZD16-33 I_{ZT} = 25 mA (pulse).
MZD36-82 I_{ZT} = 10 mA (pulse).
MZD91-200 I_{ZT} = 5 mA (pulse).

Tolerance is $\pm(5$ to 8.5)% depending on type number.

16. **1N5913B-56B**

I_{ZT} @ approximately 375 mW point (T.E.).

- A suffix = $\pm 10\%$.
- B suffix = $\pm 5\%$.

17. **3EZ3.9D5-400D5**

I_{ZT} @ approximately 750 mW point (pulse).

- Suffix 10 = $\pm 10\%$.
- Suffix 5 = $\pm 5\%$.

18. **1N5333B-88B**



I_{ZT} varies from 0.9 to 1.5 W point depending on type number (pulse).

- A suffix = $\pm 10\%$.
 - B suffix = $\pm 5\%$.
- Also has delta V_Z parameter and limit.

SELECTOR GUIDE

Zener Voltage Regulator Diodes



Surface Mount Packages (See Section 4.2.4 for complete data)

Nominal Zener Breakdown Voltage	225 mW Surface Mount		500 mW Surface Mount Leadless	500 mW Low Level Surface Mount Leadless	500 mW Surface Mount Leadless	1.5 Watt Surface Mount
	SOT-23		MLL34	MLL34	MLL34	SMB
(*Note 1)	(*Note 2)	(*Note 3)	(*Note 4)	(*Note 5)	(*Note 6)	(*Note 7)
Volts	 <p>Anode Cathode No Connection Plastic Case 318-07 TO-236AB</p>		 <p>Cathode = Polarity Band Glass Case 362-03</p>		 <p>Cathode = Notch Plastic Case 403A-03</p>	
1.8				MLL4678		
2.0				MLL4679		
2.2				MLL4680		
2.4	BZX84C2V4L	MMBZ5221BL	BZV55C2V4	MLL4681	MLL5221B	
2.5		MMBZ5222BL			MLL5222B	
2.7	BZX84C2V7L	MMBZ5223BL	BZV55C2V7	MLL4682	MLL5223B	
2.8		MMBZ5224BL			MLL5224B	
3.0	BZX84C3V0L	MMBZ5225BL	BZV55C3V0	MLL4683	MLL5225B	
3.3	BZX84C3V3L	MMBZ5226BL	BZV55C3V3	MLL4684	MLL5226B	1SMB5913BT3
3.6	BZX84C3V6L	MMBZ5227BL	BZV55C3V6	MLL4685	MLL5227B	1SMB5914BT3
3.9	BZX84C3V9L	MMBZ5228BL	BZV55C3V9	MLL4686	MLL5228B	1SMB5915BT3
4.3	BZX84C4V3L	MMBZ5229BL	BZV55C4V3	MLL4687	MLL5229B	1SMB5916BT3
4.7	BZX84C4V7L	MMBZ5230BL	BZV55C4V7	MLL4688	MLL5230B	1SMB5917BT3
5.1	BZX84C5V1L	MMBZ5231BL	BZV55C5V1	MLL4689	MLL5231B	1SMB5918BT3
5.6	BZX84C5V6L	MMBZ5232BL	BZV55C5V6	MLL4690	MLL5232B	1SMB5919BT3
6.0		MMBZ5233BL			MLL5233B	
6.2	BZX84C6V2L	MMBZ5234BL	BZV55C6V2	MLL4691	MLL5234B	1SMB5920BT3
6.8	BZX84C6V8L	MMBZ5235BL	BZV55C6V8	MLL4692	MLL5235B	1SMB5921BT3
7.5	BZX84C7V5L	MMBZ5236BL	BZV55C7V5	MLL4693	MLL5236B	1SMB5922BT3
8.2	BZX84C8V2L	MMBZ5237BL	BZV55C8V2	MLL4694	MLL5237B	1SMB5923BT3
8.7		MMBZ5238BL		MLL4695	MLL5238B	
9.1	DZX84C9V1L	MMBZ5239DL	BZV55C9V1	MLL4696	MLL5239B	1SMB5924BT3
10	BZX84C10L	MMBZ5240BL	BZV55C10	MLL4697	MLL5240B	1SMB5925BT3
11	BZX84C11L	MMBZ5241BL	BZV55C11	MLL4698	MLL5241B	1SMB5926BT3
12	BZX84C12L	MMBZ5242BL	BZV55C12	MLL4699	MLL5242B	1SMB5927BT3
13	BZX84C13L	MMBZ5243BL	BZV55C13	MLL4700	MLL5243B	1SMB5928BT3
14		MMBZ5244BL		MLL4701	MLL5244B	
15	BZX84C15L	MMBZ5245BL	BZV55C15	MLL4702	MLL5245B	1SMB5929BT3
16	BZX84C16L	MMBZ5246BL	BZV55C16	MLL4703	MLL5246B	1SMB5930BT3
17		MMBZ5247BL		MLL4704	MLL5247B	
18	BZX84C18L	MMBZ5248BL	BZV55C18	MLL4705	MLL5248B	1SMB5931BT3
19		MMBZ5249BL		MLL4706	MLL5249B	
20	BZX84C20L	MMBZ5250BL	BZV55C20	MLL4707	MLL5250B	1SMB5932BT3
22	BZX84C22L	MMBZ5251BL	BZV55C22	MLL4708	MLL5251B	1SMB5933BT3
24	BZX84C24L	MMBZ5252BL	BZV55C24	MLL4709	MLL5252B	1SMB5934BT3
25		MMBZ5253BL		MLL4710	MLL5253B	
27	BZX84C27L	MMBZ5254BL	BZV55C27	MLL4711	MLL5254B	1SMB5935BT3
28		MMBZ5255BL		MLL4712	MLL5255B	
30	BZX84C30L	MMBZ5256BL	BZV55C30	MLL4713	MLL5256B	1SMB5936BT3
33	BZX84C33L	MMBZ5257BL	BZV55C33	MLL4714	MLL5257B	1SMB5937BT3
36	BZX84C36L	MMBZ5258BL	BZV55C36	MLL4715	MLL5258B	1SMB5938BT3
39	BZX84C39L	MMBZ5259BL	BZV55C39	MLL4716	MLL5259B	1SMB5939BT3
43	BZX84C43L	MMBZ5260BL	BZV55C43	MLL4717	MLL5260B	1SMB5940BT3

*See Notes — page 4-2-9

SELECTOR GUIDE

Surface Mount Packages (continued) (See Section 4.2.4 for complete data)

Nominal Zener Breakdown Voltage	225 mW Surface Mount SOT-23		500 mW Surface Mount Leadless MLL34	500 mW Low Level Surface Mount Leadless MLL34	500 mW Surface Mount Leadless MLL34	1.5 Watt Surface Mount SMB
(*Note 1)	(*Note 2)	(*Note 3)	(*Note 4)	(*Note 5)	(*Note 6)	(*Note 7)
Volts	 Anode Cathode No Connection Plastic Case 318-07 TO-236AB		 Glass Case 362-03 Cathode = Polarity Band		 Plastic Case 403A-03 Cathode = Notch	
47	BZX84C47L	MMBZ5261BL	BZV55C47		MLL5261B	1SMB5941BT3
51	BZX84C51L	MMBZ5262BL	BZV55C51		MLL5262B	1SMB5942BT3
56	BZX84C56L	MMBZ5263BL	BZV55C56		MLL5263B	1SMB5943BT3
60		MMBZ5264BL				
62	BZX84C62L	MMBZ5265BL				1SMB5944BT3
68	BZX84C68L	MMBZ5266BL				1SMB5945BT3
75	BZX84C75L	MMBZ5267BL				1SMB5946BT3
82		MMBZ5268BL				1SMB5947BT3
87		MMBZ5269BL				
91		MMBZ5270BL				
100						1SMB5948BT3
110						1SMB5949BT3
120						1SMB5950BT3
130						1SMB5951BT3
150						1SMB5952BT3
160						1SMB5953BT3
170						1SMB5954BT3
180						
200						1SMB5955BT3 1SMB5956BT3

*See Notes on this page.

NOTES — SURFACE MOUNT CHART

1. **Zener Voltage** is the key parameter for each device type. It is specified at a particular test current applied at either thermal equilibrium (T.E.) or pulse test condition. The voltage tolerance for the device types listed is, in general $\pm 5\%$; however, for some series, the voltage tolerance varies from device type to device type over a range of $\pm(5$ to $8.5)\%$. Consult the complete data sheet to determine the exact test conditions and minimum/maximum limits for the zener voltage.

Power Ratings represent the capability of the case size listed as supplied by Motorola. These ratings may be higher than the same device types supplied by other manufacturers.

V_Z TEST CONDITIONS AND TOLERANCES

- BZX84C2V4L-C24L** $I_{ZT} = 5$ mA (pulse).
BZX84C27L-C75L $I_{ZT} = 2$ mA (pulse).
Tolerance is $\pm(5$ to $8.5)\%$ depending on type number. Each device type also has other V_Z min/max limits at two other I_{ZT} pulse current values.
- MMBZ5221BL-42BL** $I_{ZT} = 20$ mA (pulse).
MMBZ5243BL-70BL $I_{ZT} @$ approximately 125 mW point (pulse).
BL suffix = $\pm 5\%$.

- BZV55C2V4-C24** $I_{ZT} = 5$ mA (pulse).
BZV55C27-C56 $I_{ZT} = 2$ mA (pulse).
Tolerance is $\pm(5$ to $8.5)\%$ depending on type number. Each device type also has other V_Z min/max limits at two other I_{ZT} pulse current values.

- MLL4670 Series** $I_{ZT} = 50$ μ A (T.E.).
No suffix = $\pm 5\%$.

- MLL5221B-42B** $I_{ZT} = 20$ mA (T.E.).
MLL5243B-63B
 $I_{ZT} @$ approximately 125 mW point (T.E.).
A suffix = $\pm 10\%$.
B suffix = $\pm 5\%$.

- 1SMB5913BT3 Series**
 $I_{ZT} @$ approximately 375 mW point (T.E.).
BT3 suffix = $\pm 5\%$.

4

4.2

4

4.2

Section 4.2.2 Data Sheet Category Listing

Zener Voltage Regulator Diodes

Section	Data Sheets	Page	Section	Data Sheets	Page
4.2.4.1	AXIAL LEADED	4-2-21	4.2.4.2	SURFACE MOUNTED	4-2-63
4.2.4.1.1	500 mW DO-35 Glass	4-2-21	4.2.4.2.1	225 mW SOT-23	4-2-63
	General Data — 500 mW			General Data — 225 mW	
	DO-35 Glass	4-2-22		SOT-23	4-2-64
	1N746A thru 1N759A,			BZX84C2V4L thru	
	1N957B thru 1N992B,			BZX84C75L	4-2-65
	1N4370A thru 1N4372A ..	4-2-28		MMBZ5221BL thru	
	1N4678 thru 1N4717	4-2-30		MMBZ5270BL	4-2-66
	1N5221B thru 1N5281B	4-2-31	4.2.4.2.2	500 mW Leadless	
	1N5985B thru 1N6025B	4-2-33		(DO-34 Body Size)	4-2-67
	BZX55C2V4 thru			General Data — 500 mW	
	BZX55C91	4-2-34		Leadless	4-2-68
	BZX79C2V4 thru			BZV55C2V4 thru	
	BZX79C200	4-2-35		BZV55C56	4-2-73
	BZX83C2V7 thru BZX83C33,			MLL4678 thru MLL4717	4-2-74
	M-ZPD2.7 thru M-ZPD33 .	4-2-36		MLL5221B thru MLL5263B .	4-2-75
	MZ4099 thru MZ4104,		4.2.4.2.3	1.5 Watt DC Power —	
	MZ4614 thru MZ4627	4-2-37		(SMB Flat Plastic with Modified	
	MZ5520B thru MZ5530B	4-2-38		L-Bend Leads)	4-2-77
4.2.4.1.2	1-1.3 Watt DO-41 Glass	4-2-39		1SMB5913BT3 thru	
	General Data — 1-1.3 Watt			1SMB5956BT3	4-2-78
	DO-41 Glass	4-2-40			
	1N4728A thru 1N4764A	4-2-44			
	BZX85C3V3 thru				
	BZX85C100	4-2-45			
	M-ZPY3.9 thru M-ZPY100 ..	4-2-46			
4.2.4.1.3	1-3 Watt DO-41 Surmetic 30 ..	4-2-47			
	General Data — 1-3 Watt				
	DO-41 Surmetic 30	4-2-48			
	1N5913B thru 1N5956B	4-2-51			
	3EZ3.9D5 thru 3EZ400D5 ..	4-2-53			
	MZD3.9 thru MZD200	4-2-55			
	MZP4728A thru MZP4764A,				
	1M110ZS5 thru 1M200ZS5 .	4-2-56			
4.2.4.1.4	5 Watt Surmetic 40	4-2-57			
	1N5333B thru 1N5388B	4-2-58			

Section 4.2.3 Alphanumeric Part Number Listing Zener Voltage Regulator Diodes

4

4.2

ALPHANUMERIC INDEX – VOLTAGE REGULATOR DIODES

DEVICE	PAGE	DEVICE	PAGE	DEVICE	PAGE
1M110ZS5	4-2-56	1N975B	4-2-28	1N4696	4-2-30
1M120ZS5	4-2-56	1N976B	4-2-28	1N4697	4-2-30
1M130ZS5	4-2-56	1N977B	4-2-28	1N4698	4-2-30
1M150ZS5	4-2-56	1N978B	4-2-28	1N4699	4-2-30
1M160ZS5	4-2-56	1N979B	4-2-28	1N4700	4-2-30
1M180ZS5	4-2-56	1N980B	4-2-28	1N4701	4-2-30
1M200ZS5	4-2-56	1N981B	4-2-29	1N4702	4-2-30
1N746A	4-2-28	1N982B	4-2-29	1N4703	4-2-30
1N747A	4-2-28	1N983B	4-2-29	1N4704	4-2-30
1N748A	4-2-28	1N984B	4-2-29	1N4705	4-2-30
1N749A	4-2-28	1N985B	4-2-29	1N4706	4-2-30
1N750A	4-2-28	1N986B	4-2-29	1N4707	4-2-30
1N751A	4-2-28	1N987B	4-2-29	1N4708	4-2-30
1N752A	4-2-28	1N988B	4-2-29	1N4709	4-2-30
1N753A	4-2-28	1N989B	4-2-29	1N4710	4-2-30
1N754A	4-2-28	1N990B	4-2-29	1N4711	4-2-30
1N755A	4-2-28	1N991B	4-2-29	1N4712	4-2-30
1N756A	4-2-28	1N992B	4-2-29	1N4713	4-2-30
1N757A	4-2-28	1N4370A	4-2-28	1N4714	4-2-30
1N758A	4-2-28	1N4371A	4-2-28	1N4715	4-2-30
1N759A	4-2-28	1N4372A	4-2-28	1N4716	4-2-30
1N957B	4-2-28	1N4678	4-2-30	1N4717	4-2-30
1N958B	4-2-28	1N4679	4-2-30	1N4728A	4-2-44
1N959B	4-2-28	1N4680	4-2-30	1N4729A	4-2-44
1N960B	4-2-28	1N4681	4-2-30	1N4730A	4-2-44
1N961B	4-2-28	1N4682	4-2-30	1N4731A	4-2-44
1N962B	4-2-28	1N4683	4-2-30	1N4732A	4-2-44
1N963B	4-2-28	1N4684	4-2-30	1N4733A	4-2-44
1N964B	4-2-28	1N4685	4-2-30	1N4734A	4-2-44
1N965B	4-2-28	1N4686	4-2-30	1N4735A	4-2-44
1N966B	4-2-28	1N4687	4-2-30	1N4736A	4-2-44
1N967B	4-2-28	1N4688	4-2-30	1N4737A	4-2-44
1N968B	4-2-28	1N4689	4-2-30	1N4738A	4-2-44
1N969B	4-2-28	1N4690	4-2-30	1N4739A	4-2-44
1N970B	4-2-28	1N4691	4-2-30	1N4740A	4-2-44
1N971B	4-2-28	1N4692	4-2-30	1N4741A	4-2-44
1N972B	4-2-28	1N4693	4-2-30	1N4742A	4-2-44
1N973B	4-2-28	1N4694	4-2-30	1N4743A	4-2-44
1N974B	4-2-28	1N4695	4-2-30	1N4744A	4-2-44

ALPHANUMERIC INDEX (continued)

DEVICE	PAGE	DEVICE	PAGE	DEVICE	PAGE
1N4745A	4-2-44	1N5242B	4-2-31	1N5334B	4-2-59
1N4746A	4-2-44	1N5243B	4-2-31	1N5335B	4-2-59
1N4747A	4-2-44	1N5244B	4-2-31	1N5336B	4-2-59
1N4748A	4-2-44	1N5245B	4-2-31	1N5337B	4-2-59
1N4749A	4-2-44	1N5246B	4-2-31	1N5338B	4-2-59
1N4750A	4-2-44	1N5247B	4-2-31	1N5339B	4-2-59
1N4751A	4-2-44	1N5248B	4-2-31	1N5340B	4-2-59
1N4752A	4-2-44	1N5249B	4-2-31	1N5341B	4-2-59
1N4753A	4-2-44	1N5250B	4-2-31	1N5342B	4-2-59
1N4754A	4-2-44	1N5251B	4-2-31	1N5343B	4-2-59
1N4755A	4-2-44	1N5252B	4-2-31	1N5344B	4-2-59
1N4756A	4-2-44	1N5253B	4-2-31	1N5345B	4-2-59
1N4757A	4-2-44	1N5254B	4-2-31	1N5346B	4-2-59
1N4758A	4-2-44	1N5255B	4-2-31	1N5347B	4-2-59
1N4759A	4-2-44	1N5256B	4-2-31	1N5348B	4-2-59
1N4760A	4-2-44	1N5257B	4-2-31	1N5349B	4-2-59
1N4761A	4-2-44	1N5258B	4-2-31	1N5350B	4-2-59
1N4762A	4-2-44	1N5259B	4-2-31	1N5351B	4-2-59
1N4763A	4-2-44	1N5260B	4-2-31	1N5352B	4-2-59
1N4764A	4-2-44	1N5261B	4-2-31	1N5353B	4-2-59
1N5221B	4-2-31	1N5262B	4-2-31	1N5354B	4-2-59
1N5222B	4-2-31	1N5263B	4-2-31	1N5355B	4-2-59
1N5223B	4-2-31	1N5264B	4-2-31	1N5356B	4-2-59
1N5224B	4-2-31	1N5265B	4-2-31	1N5357B	4-2-59
1N5225B	4-2-31	1N5266B	4-2-32	1N5358B	4-2-59
1N5226B	4-2-31	1N5267B	4-2-32	1N5359B	4-2-59
1N5227B	4-2-31	1N5268B	4-2-32	1N5360B	4-2-59
1N5228B	4-2-31	1N5269B	4-2-32	1N5361B	4-2-59
1N5229B	4-2-31	1N5270B	4-2-32	1N5362B	4-2-59
1N5230B	4-2-31	1N5271B	4-2-32	1N5363B	4-2-59
1N5231B	4-2-31	1N5272B	4-2-32	1N5364B	4-2-59
1N5232B	4-2-31	1N5273B	4-2-32	1N5365B	4-2-59
1N5233B	4-2-31	1N5274B	4-2-32	1N5366B	4-2-59
1N5234B	4-2-31	1N5275B	4-2-32	1N5367B	4-2-59
1N5235B	4-2-31	1N5276B	4-2-32	1N5368B	4-2-59
1N5236B	4-2-31	1N5277B	4-2-32	1N5369B	4-2-59
1N5237B	4-2-31	1N5278B	4-2-32	1N5370B	4-2-59
1N5238B	4-2-31	1N5279B	4-2-32	1N5371B	4-2-59
1N5239B	4-2-31	1N5280B	4-2-32	1N5372B	4-2-59
1N5240B	4-2-31	1N5281B	4-2-32	1N5373B	4-2-59
1N5241B	4-2-31	1N5333B	4-2-59	1N5374B	4-2-59

ALPHANUMERIC INDEX (continued)

DEVICE	PAGE	DEVICE	PAGE	DEVICE	PAGE
1N5375B	4-2-59	1N5940B	4-2-51	1N6009B	4-2-33
1N5376B	4-2-59	1N5941B	4-2-51	1N6010B	4-2-33
1N5377B	4-2-59	1N5942B	4-2-51	1N6011B	4-2-33
1N5378B	4-2-59	1N5943B	4-2-51	1N6012B	4-2-33
1N5379B	4-2-59	1N5944B	4-2-51	1N6013B	4-2-33
1N5380B	4-2-59	1N5945B	4-2-51	1N6014B	4-2-33
1N5381B	4-2-59	1N5946B	4-2-51	1N6015B	4-2-33
1N5382B	4-2-59	1N5947B	4-2-51	1N6016B	4-2-33
1N5383B	4-2-60	1N5948B	4-2-52	1N6017B	4-2-33
1N5384B	4-2-60	1N5949B	4-2-52	1N6018B	4-2-33
1N5385B	4-2-60	1N5950B	4-2-52	1N6019B	4-2-33
1N5386B	4-2-60	1N5951B	4-2-52	1N6020B	4-2-33
1N5387B	4-2-60	1N5952B	4-2-52	1N6021B	4-2-33
1N5388B	4-2-60	1N5953B	4-2-52	1N6022B	4-2-33
1N5913B	4-2-51	1N5954B	4-2-52	1N6023B	4-2-33
1N5914B	4-2-51	1N5955B	4-2-52	1N6024B	4-2-33
1N5915B	4-2-51	1N5956B	4-2-52	1N6025B	4-2-33
1N5916B	4-2-51	1N5985B	4-2-33	1SMB5913BT3	4-2-78
1N5917B	4-2-51	1N5986B	4-2-33	1SMB5914BT3	4-2-78
1N5918B	4-2-51	1N5987B	4-2-33	1SMB5915BT3	4-2-78
1N5919B	4-2-51	1N5988B	4-2-33	1SMB5916BT3	4-2-78
1N5920B	4-2-51	1N5989B	4-2-33	1SMB5917BT3	4-2-78
1N5921B	4-2-51	1N5990B	4-2-33	1SMB5918BT3	4-2-78
1N5922B	4-2-51	1N5991B	4-2-33	1SMB5919BT3	4-2-78
1N5923B	4-2-51	1N5992B	4-2-33	1SMB5920BT3	4-2-78
1N5924B	4-2-51	1N5993B	4-2-33	1SMB5921BT3	4-2-78
1N5925B	4-2-51	1N5994B	4-2-33	1SMB5922BT3	4-2-78
1N5926B	4-2-51	1N5995B	4-2-33	1SMB5923BT3	4-2-78
1N5927B	4-2-51	1N5996B	4-2-33	1SMB5924BT3	4-2-78
1N5928B	4-2-51	1N5997B	4-2-33	1SMB5925BT3	4-2-78
1N5929B	4-2-51	1N5998B	4-2-33	1SMB5926BT3	4-2-78
1N5930B	4-2-51	1N5999B	4-2-33	1SMB5927BT3	4-2-78
1N5931B	4-2-51	1N6000B	4-2-33	1SMB5928BT3	4-2-78
1N5932B	4-2-51	1N6001B	4-2-33	1SMB5929BT3	4-2-79
1N5933B	4-2-51	1N6002B	4-2-33	1SMB5930BT3	4-2-79
1N5934B	4-2-51	1N6003B	4-2-33	1SMB5931BT3	4-2-79
1N5935B	4-2-51	1N6004B	4-2-33	1SMB5932BT3	4-2-79
1N5936B	4-2-51	1N6005B	4-2-33	1SMB5933BT3	4-2-79
1N5937B	4-2-51	1N6006B	4-2-33	1SMB5934BT3	4-2-79
1N5938B	4-2-51	1N6007B	4-2-33	1SMB5935BT3	4-2-79
1N5939B	4-2-51	1N6008B	4-2-33	1SMB5936BT3	4-2-79

ALPHANUMERIC INDEX (continued)

DEVICE	PAGE	DEVICE	PAGE	DEVICE	PAGE
1SMB5937BT3	4-2-79	3EZ22D5	4-2-53	BZV55C4V3	4-2-73
1SMB5938BT3	4-2-79	3EZ24D5	4-2-53	BZV55C4V7	4-2-73
1SMB5939BT3	4-2-79	3EZ27D5	4-2-53	BZV55C5V1	4-2-73
1SMB5940BT3	4-2-79	3EZ28D5	4-2-53	BZV55C5V6	4-2-73
1SMB5941BT3	4-2-79	3EZ30D5	4-2-53	BZV55C6V2	4-2-73
1SMB5942BT3	4-2-79	3EZ33D5	4-2-53	BZV55C6V8	4-2-73
1SMB5943BT3	4-2-79	3EZ36D5	4-2-53	BZV55C7V5	4-2-73
1SMB5944BT3	4-2-79	3EZ39D5	4-2-53	BZV55C8V2	4-2-73
1SMB5945BT3	4-2-79	3EZ43D5	4-2-53	BZV55C9V1	4-2-73
1SMB5946BT3	4-2-79	3EZ47D5	4-2-53	BZV55C10	4-2-73
1SMB5947BT3	4-2-79	3EZ51D5	4-2-53	BZV55C11	4-2-73
1SMB5948BT3	4-2-79	3EZ56D5	4-2-53	BZV55C12	4-2-73
1SMB5949BT3	4-2-79	3EZ62D5	4-2-53	BZV55C13	4-2-73
1SMB5950BT3	4-2-79	3EZ68D5	4-2-53	BZV55C15	4-2-73
1SMB5951BT3	4-2-79	3EZ75D5	4-2-53	BZV55C16	4-2-73
1SMB5952BT3	4-2-79	3EZ82D5	4-2-53	BZV55C18	4-2-73
1SMB5953BT3	4-2-79	3EZ91D5	4-2-53	BZV55C20	4-2-73
1SMB5954BT3	4-2-79	3EZ100D5	4-2-53	BZV55C22	4-2-73
1SMB5955BT3	4-2-79	3EZ110D5	4-2-53	BZV55C24	4-2-73
1SMB5956BT3	4-2-79	3EZ120D5	4-2-53	BZV55C27	4-2-73
3EZ3.9D5	4-2-53	3EZ130D5	4-2-53	BZV55C30	4-2-73
3EZ4.3D5	4-2-53	3EZ140D5	4-2-53	BZV55C33	4-2-73
3EZ4.7D5	4-2-53	3EZ150D5	4-2-53	BZV55C36	4-2-73
3EZ5.1D5	4-2-53	3EZ160D5	4-2-53	BZV55C39	4-2-73
3EZ5.6D5	4-2-53	3EZ170D5	4-2-53	BZV55C43	4-2-73
3EZ6.2D5	4-2-53	3EZ180D5	4-2-53	BZV55C47	4-2-73
3EZ6.8D5	4-2-53	3EZ190D5	4-2-53	BZV55C51	4-2-73
3EZ7.5D5	4-2-53	3EZ200D5	4-2-54	BZV55C56	4-2-73
3EZ8.2D5	4-2-53	3EZ220D5	4-2-54	BZX55C2V4	4-2-34
3EZ9.1D5	4-2-53	3EZ240D5	4-2-54	BZX55C2V7	4-2-34
3EZ10D5	4-2-53	3EZ270D5	4-2-54	BZX55C3V0	4-2-34
3EZ11D5	4-2-53	3EZ300D5	4-2-54	BZX55C3V3	4-2-34
3EZ12D5	4-2-53	3EZ330D5	4-2-54	BZX55C3V6	4-2-34
3EZ13D5	4-2-53	3EZ360D5	4-2-54	BZX55C3V9	4-2-34
3EZ14D5	4-2-53	3EZ400D5	4-2-54	BZX55C4V3	4-2-34
3EZ15D5	4-2-53	BZV55C2V4	4-2-73	BZX55C4V7	4-2-34
3EZ16D5	4-2-53	BZV55C2V7	4-2-73	BZX55C5V1	4-2-34
3EZ17D5	4-2-53	BZV55C3V0	4-2-73	BZX55C5V6	4-2-34
3EZ18D5	4-2-53	BZV55C3V3	4-2-73	BZX55C6V2	4-2-34
3EZ19D5	4-2-53	BZV55C3V6	4-2-73	BZX55C6V8	4-2-34
3EZ20D5	4-2-53	BZV55C3V9	4-2-73	BZX55C7V5	4-2-34

ALPHANUMERIC INDEX (continued)

DEVICE	PAGE	DEVICE	PAGE	DEVICE	PAGE
BZX55C8V2	4-2-34	BZX79C10	4-2-35	BZX83C6V2	4-2-36
BZX55C9V1	4-2-34	BZX79C11	4-2-35	BZX83C6V8	4-2-36
BZX55C10	4-2-34	BZX79C12	4-2-35	BZX83C7V5	4-2-36
BZX55C11	4-2-34	BZX79C13	4-2-35	BZX83C8V2	4-2-36
BZX55C12	4-2-34	BZX79C15	4-2-35	BZX83C9V1	4-2-36
BZX55C13	4-2-34	BZX79C16	4-2-35	BZX83C10	4-2-36
BZX55C15	4-2-34	BZX79C18	4-2-35	BZX83C11	4-2-36
BZX55C16	4-2-34	BZX79C20	4-2-35	BZX83C12	4-2-36
BZX55C18	4-2-34	BZX79C22	4-2-35	BZX83C13	4-2-36
BZX55C20	4-2-34	BZX79C24	4-2-35	BZX83C15	4-2-36
BZX55C22	4-2-34	BZX79C27	4-2-35	BZX83C16	4-2-36
BZX55C24	4-2-34	BZX79C30	4-2-35	BZX83C18	4-2-36
BZX55C27	4-2-34	BZX79C33	4-2-35	BZX83C20	4-2-36
BZX55C30	4-2-34	BZX79C36	4-2-35	BZX83C22	4-2-36
BZX55C33	4-2-34	BZX79C39	4-2-35	BZX83C24	4-2-36
BZX55C36	4-2-34	BZX79C43	4-2-35	BZX83C27	4-2-36
BZX55C39	4-2-34	BZX79C47	4-2-35	BZX83C30	4-2-36
BZX55C43	4-2-34	BZX79C51	4-2-35	BZX83C33	4-2-36
BZX55C47	4-2-34	BZX79C56	4-2-35	BZX84C2V4L	4-2-65
BZX55C51	4-2-34	BZX79C62	4-2-35	BZX84C2V7L	4-2-65
BZX55C56	4-2-34	BZX79C68	4-2-35	BZX84C3V0L	4-2-65
BZX55C62	4-2-34	BZX79C75	4-2-35	BZX84C3V3L	4-2-65
BZX55C68	4-2-34	BZX79C82	4-2-35	BZX84C3V6L	4-2-65
BZX55C75	4-2-34	BZX79C91	4-2-35	BZX84C3V9L	4-2-65
BZX55C82	4-2-34	BZX79C100	4-2-35	BZX84C4V3L	4-2-65
BZX55C91	4-2-34	BZX79C110	4-2-35	BZX84C4V7L	4-2-65
BZX79C2V4	4-2-35	BZX79C120	4-2-35	BZX84C5V1L	4-2-65
BZX79C2V7	4-2-35	BZX79C130	4-2-35	BZX84C5V6L	4-2-65
BZX79C3V0	4-2-35	BZX79C150	4-2-35	BZX84C6V2L	4-2-65
BZX79C3V3	4-2-35	BZX79C160	4-2-35	BZX84C6V8L	4-2-65
BZX79C3V6	4-2-35	BZX79C180	4-2-35	BZX84C7V5L	4-2-65
BZX79C3V9	4-2-35	BZX79C200	4-2-35	BZX84C8V2L	4-2-65
BZX79C4V3	4-2-35	BZX83C2V7	4-2-36	BZX84C9V1L	4-2-65
BZX79C4V7	4-2-35	BZX83C3V0	4-2-36	BZX84C10L	4-2-65
BZX79C5V1	4-2-35	BZX83C3V3	4-2-36	BZX84C11L	4-2-65
BZX79C5V6	4-2-35	BZX83C3V6	4-2-36	BZX84C12L	4-2-65
BZX79C6V2	4-2-35	BZX83C3V9	4-2-36	BZX84C13L	4-2-65
BZX79C6V8	4-2-35	BZX83C4V3	4-2-36	BZX84C15L	4-2-65
BZX79C7V5	4-2-35	BZX83C4V7	4-2-36	BZX84C16L	4-2-65
BZX79C8V2	4-2-35	BZX83C5V1	4-2-36	BZX84C18L	4-2-65
BZX79C9V1	4-2-35	BZX83C5V6	4-2-36	BZX84C20L	4-2-65

ALPHANUMERIC INDEX (continued)

DEVICE	PAGE	DEVICE	PAGE	DEVICE	PAGE
BZX84C22L	4-2-65	BZX85C43	4-2-45	MLL4709	4-2-74
BZX84C24L	4-2-65	BZX85C47	4-2-45	MLL4710	4-2-74
BZX84C27L	4-2-65	BZX85C51	4-2-45	MLL4711	4-2-74
BZX84C30L	4-2-65	BZX85C56	4-2-45	MLL4712	4-2-74
BZX84C33L	4-2-65	BZX85C62	4-2-45	MLL4713	4-2-74
BZX84C36L	4-2-65	BZX85C68	4-2-45	MLL4714	4-2-74
BZX84C39L	4-2-65	BZX85C75	4-2-45	MLL4715	4-2-74
BZX84C43L	4-2-65	BZX85C82	4-2-45	MLL4716	4-2-74
BZX84C47L	4-2-65	BZX85C91	4-2-45	MLL4717	4-2-74
BZX84C51L	4-2-65	BZX85C100	4-2-45	MLL5221B	4-2-75
BZX84C56L	4-2-65	MLL4678	4-2-74	MLL5222B	4-2-75
BZX84C62L	4-2-65	MLL4679	4-2-74	MLL5223B	4-2-75
BZX84C68L	4-2-65	MLL4680	4-2-74	MLL5224B	4-2-75
BZX84C75L	4-2-65	MLL4681	4-2-74	MLL5225B	4-2-75
BZX85C3V3	4-2-45	MLL4682	4-2-74	MLL5226B	4-2-75
BZX85C3V6	4-2-45	MLL4683	4-2-74	MLL5227B	4-2-75
BZX85C3V9	4-2-45	MLL4684	4-2-74	MLL5228B	4-2-75
BZX85C4V3	4-2-45	MLL4685	4-2-74	MLL5229B	4-2-75
BZX85C4V7	4-2-45	MLL4686	4-2-74	MLL5230B	4-2-75
BZX85C5V1	4-2-45	MLL4687	4-2-74	MLL5231B	4-2-75
BZX85C5V6	4-2-45	MLL4688	4-2-74	MLL5232B	4-2-75
BZX85C6V2	4-2-45	MLL4689	4-2-74	MLL5233B	4-2-75
BZX85C6V8	4-2-45	MLL4690	4-2-74	MLL5234B	4-2-75
BZX85C7V5	4-2-45	MLL4691	4-2-74	MLL5235B	4-2-75
BZX85C8V2	4-2-45	MLL4692	4-2-74	MLL5236B	4-2-75
BZX85C9V1	4-2-45	MLL4693	4-2-74	MLL5237B	4-2-75
BZX85C10	4-2-45	MLL4694	4-2-74	MLL5238B	4-2-75
BZX85C11	4-2-45	MLL4695	4-2-74	MLL5239B	4-2-75
BZX85C12	4-2-45	MLL4696	4-2-74	MLL5240B	4-2-75
BZX85C13	4-2-45	MLL4697	4-2-74	MLL5241B	4-2-75
BZX85C15	4-2-45	MLL4698	4-2-74	MLL5242B	4-2-75
BZX85C16	4-2-45	MLL4699	4-2-74	MLL5243B	4-2-75
BZX85C18	4-2-45	MLL4700	4-2-74	MLL5244B	4-2-75
BZX85C20	4-2-45	MLL4701	4-2-74	MLL5245B	4-2-75
BZX85C22	4-2-45	MLL4702	4-2-74	MLL5246B	4-2-75
BZX85C24	4-2-45	MLL4703	4-2-74	MLL5247B	4-2-75
BZX85C27	4-2-45	MLL4704	4-2-74	MLL5248B	4-2-75
BZX85C30	4-2-45	MLL4705	4-2-74	MLL5249B	4-2-75
BZX85C33	4-2-45	MLL4706	4-2-74	MLL5250B	4-2-75
BZX85C36	4-2-45	MLL4707	4-2-74	MLL5251B	4-2-75
BZX85C39	4-2-45	MLL4708	4-2-74	MLL5252B	4-2-75

ALPHANUMERIC INDEX (continued)

DEVICE	PAGE	DEVICE	PAGE	DEVICE	PAGE
MLL5254B	4-2-75	MMBZ5252BL	4-2-66	MZ5522B	4-2-38
MLL5255B	4-2-75	MMBZ5253BL	4-2-66	MZ5523B	4-2-38
MLL5256B	4-2-75	MMBZ5254BL	4-2-66	MZ5524B	4-2-38
MLL5257B	4-2-75	MMBZ5255BL	4-2-66	MZ5525B	4-2-38
MLL5258B	4-2-75	MMBZ5256BL	4-2-66	MZ5526B	4-2-38
MLL5259B	4-2-75	MMBZ5257BL	4-2-66	MZ5527B	4-2-38
MLL5260B	4-2-75	MMBZ5258BL	4-2-66	MZ5528B	4-2-38
MLL5261B	4-2-75	MMBZ5259BL	4-2-66	MZ5529B	4-2-38
MLL5262B	4-2-75	MMBZ5260BL	4-2-66	MZ5530B	4-2-38
MLL5263B	4-2-75	MMBZ5261BL	4-2-66	MZD3.9	4-2-55
MMBZ5221BL	4-2-66	MMBZ5262BL	4-2-66	MZD4.3	4-2-55
MMBZ5222BL	4-2-66	MMBZ5263BL	4-2-66	MZD4.7	4-2-55
MMBZ5223BL	4-2-66	MMBZ5264BL	4-2-66	MZD5.1	4-2-55
MMBZ5224BL	4-2-66	MMBZ5265BL	4-2-66	MZD5.6	4-2-55
MMBZ5225BL	4-2-66	MMBZ5266BL	4-2-66	MZD6.2	4-2-55
MMBZ5226BL	4-2-66	MMBZ5267BL	4-2-66	MZD6.8	4-2-55
MMBZ5227BL	4-2-66	MMBZ5268BL	4-2-66	MZD7.5	4-2-55
MMBZ5228BL	4-2-66	MMBZ5269BL	4-2-66	MZD8.2	4-2-55
MMBZ5229BL	4-2-66	MMBZ5270BL	4-2-66	MZD9.1	4-2-55
MMBZ5230BL	4-2-66	MZ4099	4-2-37	MZD10	4-2-55
MMBZ5231BL	4-2-66	MZ4100	4-2-37	MZD11	4-2-55
MMBZ5232BL	4-2-66	MZ4101	4-2-37	MZD12	4-2-55
MMBZ5233BL	4-2-66	MZ4102	4-2-37	MZD13	4-2-55
MMBZ5234BL	4-2-66	MZ4103	4-2-37	MZD15	4-2-55
MMBZ5235BL	4-2-66	MZ4104	4-2-37	MZD16	4-2-55
MMBZ5236BL	4-2-66	MZ4614	4-2-37	MZD18	4-2-55
MMBZ5237BL	4-2-66	MZ4615	4-2-37	MZD20	4-2-55
MMBZ5238BL	4-2-66	MZ4616	4-2-37	MZD22	4-2-55
MMBZ5239BL	4-2-66	MZ4617	4-2-37	MZD24	4-2-55
MMBZ5240BL	4-2-66	MZ4618	4-2-37	MZD27	4-2-55
MMBZ5241BL	4-2-66	MZ4619	4-2-37	MZD30	4-2-55
MMBZ5242BL	4-2-66	MZ4620	4-2-37	MZD33	4-2-55
MMBZ5243BL	4-2-66	MZ4621	4-2-37	MZD36	4-2-55
MMBZ5244BL	4-2-66	MZ4622	4-2-37	MZD39	4-2-55
MMBZ5245BL	4-2-66	MZ4623	4-2-37	MZD43	4-2-55
MMBZ5246BL	4-2-66	MZ4624	4-2-37	MZD47	4-2-55
MMBZ5247BL	4-2-66	MZ4625	4-2-37	MZD51	4-2-55
MMBZ5248BL	4-2-66	MZ4626	4-2-37	MZD56	4-2-55
MMBZ5249BL	4-2-66	MZ4627	4-2-37	MZD62	4-2-55
MMBZ5250BL	4-2-66	MZ5520B	4-2-38	MZD68	4-2-55
MMBZ5251BL	4-2-66	MZ5521B	4-2-38	MZD75	4-2-55

ALPHANUMERIC INDEX (continued)

DEVICE	PAGE	DEVICE	PAGE	DEVICE	PAGE
MZD82	4-2-55	MZP4755A	4-2-56	MZPY47	4-2-46
MZD91	4-2-55	MZP4756A	4-2-56	MZPY51	4-2-46
MZD100	4-2-55	MZP4757A	4-256	MZPY56	4-2-46
MZD110	4-2-55	MZP4758A	4-2-56	MZPY62	4-2-46
MZD120	4-2-55	MZP4759A	4-2-56	MZPY68	4-2-46
MZD130	4-2-55	MZP4760A	4-2-56	MZPY75	4-2-46
MZD150	4-2-55	MZP4761A	4-2-56	MZPY82	4-2-46
MZD160	4-2-55	MZP4762A	4-2-56	MZPY91	4-2-46
MZD180	4-2-55	MZP4763A	4-2-56	MZPY100	4-2-46
MZD200	4-2-55	MZP4764A	4-2-56	ZPD2.7	4-2-36
MZP4728A	4-2-56	MZPY3.9	4-2-46	ZPD3.0	4-2-36
MZP4729A	4-2-56	MZPY4.3	4-2-46	ZPD3.3	4-2-36
MZP4730A	4-2-56	MZPY4.7	4-2-46	ZPD3.6	4-2-36
MZP4731A	4-2-56	MZPY5.1	4-2-46	ZPD3.9	4-2-36
MZP4732A	4-2-56	MZPY5.6	4-2-46	ZPD4.3	4-2-36
MZP4733A	4-2-56	MZPY6.2	4-2-46	ZPD4.7	4-2-36
MZP4734A	4-2-56	MZPY6.8	4-2-46	ZPD5.1	4-2-36
MZP4735A	4-2-56	MZPY7.5	4-2-46	ZPD5.6	4-2-36
MZP4736A	4-2-56	MZPY8.2	4-2-46	ZPD6.2	4-2-36
MZP4737A	4-2-56	MZPY9.1	4-2-46	ZPD6.8	4-2-36
MZP4738A	4-2-56	MZPY10	4-2-46	ZPD7.5	4-2-36
MZP4739A	4-2-56	MZPY11	4-2-46	ZPD8.2	4-2-36
MZP4740A	4-2-56	MZPY12	4-2-46	ZPD9.1	4-2-36
MZP4741A	4-2-56	MZPY13	4-2-46	ZPD10	4-2-36
MZP4742A	4-2-56	MZPY15	4-2-46	ZPD11	4-2-36
MZP4743A	4-2-56	MZPY16	4-2-46	ZPD12	4-2-36
MZP4744A	4-2-56	MZPY18	4-2-46	ZPD13	4-2-36
MZP4745A	4-2-56	MZPY20	4-2-46	ZPD15	4-2-36
MZP4746A	4-2-56	MZPY22	4-2-46	ZPD16	4-2-36
MZP4747A	4-2-56	MZPY24	4-2-46	ZPD18	4-2-36
MZP4748A	4-2-56	MZPY27	4-2-46	ZPD20	4-2-36
MZP4749A	4-2-56	MZPY30	4-2-46	ZPD22	4-2-36
MZP4750A	4-2-56	MZPY33	4-2-46	ZPD24	4-2-36
MZP4751A	4-2-56	MZPY36	4-2-46	ZPD27	4-2-36
MZP4752A	4-2-56	MZPY39	4-2-46	ZPD30	4-2-36
MZP4753A	4-2-56	MZPY43	4-2-46	ZPD33	4-2-36
MZP4754A	4-2-56				

4

4.2

Section 4.2.4 Data Sheets

Zener Voltage Regulator Diodes

Section 4.2.4.1 Axial Leaded

SECTION 4.2.4.1.1 500 mW DO-35 GLASS

DATA SHEETS

Devices	Page No.
General Data — 500 mW DO-35 Glass	4-2-22
1N746A thru 1N759A, 1N957B thru 1N992B, 1N4370A thru 1N4372A	4-2-28
1N4678 thru 1N4717	4-2-30
1N5221B thru 1N5281B	4-2-31
1N5985B thru 1N6025B	4-2-33
BZX55C2V4 thru BZX55C91	4-2-34
BZX79C2V4 thru BZX79C200	4-2-35
BZX83C2V7 thru BZX83C33, M-ZPD2.7 thru M-ZPD33	4-2-36
MZ4099 thru MZ4104, MZ4614 thru MZ4627	4-2-37
MZ5520B thru MZ5530B	4-2-38

MULTIPLE PACKAGE QUANTITY (MPQ) REQUIREMENTS

Package Option	Type No. Suffix	MPQ (Units)
Tape and Reel	RL, RL2(1)	5K
Tape and Ammo	TA, TA2(1)	5K
Radial Tape and Reel	RR1, RR2(2)	3K
Radial Tape and Ammo	RA1, RA2(2)	3K

NOTES: 1. The "2" suffix refers to 26 mm tape spacing.
 2. The "1" suffix designates the cathode band is up and the cathode lead comes off first.
 The "2" suffix indicates the cathode band is down and the anode lead comes off first.

**MOTOROLA
SEMICONDUCTOR
TECHNICAL DATA**

*500 mW DO-35 Glass
Zener Voltage Regulator Diodes*
**GENERAL DATA APPLICABLE TO ALL SERIES IN
THIS GROUP**
**500 Milliwatt
Hermetically Sealed
Glass Silicon Zener Diodes**

**GENERAL
DATA**
**500 mW
DO-35 GLASS**

**GLASS ZENER DIODES
500 MILLIWATTS
1.8-200 VOLTS**

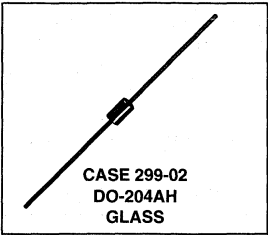

Specification Features:

- Complete Voltage Range — 1.8 to 200 Volts
- DO-204AH Package — Smaller than Conventional DO-204AA Package
- Double Slug Type Construction
- Metallurgically Bonded Construction

Mechanical Characteristics:

CASE: Double slug type, hermetically sealed glass

MAXIMUM LEAD TEMPERATURE FOR SOLDERING PURPOSES: 230°C, 1/16" from case for 10 seconds

FINISH: All external surfaces are corrosion resistant with readily solderable leads

POLARITY: Cathode indicated by color band. When operated in zener mode, cathode will be positive with respect to anode

MOUNTING POSITION: Any

4

MAXIMUM RATINGS (Motorola Devices)*			
Rating	Symbol	Value	Unit
DC Power Dissipation and $T_L \leq 75^\circ\text{C}$ Lead Length = 3/8" Derate above $T_L = 75^\circ\text{C}$	P_D	500 4	mW mW/°C
Operating and Storage Temperature Range	T_J, T_{stg}	- 65 to +200	°C

* Some part number series have lower JEDEC registered ratings.

4.2

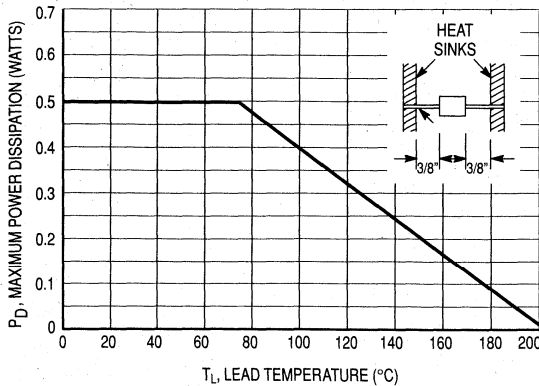

Figure 1. Steady State Power Derating

GENERAL DATA — 500 mW DO-35 GLASS

NOTE 1. SPECIAL SELECTIONS † AVAILABLE INCLUDE:

- Nominal zener voltages between those shown.
- Nominal voltages at non-standard test currents.

NOTE 2. TEMPERATURE COEFFICIENT (θ_{VZ})

Test conditions for temperature coefficient are as follows:

Figure 4a. $I_{ZT} = 7.5 \text{ mA}$, $T_1 = 25^\circ\text{C}$,

$T_2 = 125^\circ\text{C}$

Figure 4b, 4c. $I_{ZT} = \text{Rated } I_{ZT} (125 \text{ mW}/V_Z \text{ nom.})$

$T_1 = 25^\circ\text{C}$, $T_2 = 125^\circ\text{C}$

Device to be temperature stabilized with current applied prior to reading breakdown voltage at the specified ambient temperature.

NOTE 3. ZENER VOLTAGE (V_Z) MEASUREMENT

Nominal zener voltage is measured with the device junction in thermal equilibrium at the lead temperature of $30^\circ\text{C} \pm 1^\circ\text{C}$ and $3/8"$ lead length. Part number series that are pulse tested are so noted.

NOTE 4. ZENER IMPEDANCE (Z_Z) DERIVATION

Z_{ZT} and Z_{ZK} are measured by dividing the ac voltage drop across the device by the ac current applied. The specified limits are for $I_Z(\text{ac}) = 0.1 I_Z(\text{dc})$ with the ac frequency = 60 Hz.

† For more information on special selections contact your nearest Motorola representative.

APPLICATION NOTE — ZENER VOLTAGE

Since the actual voltage available from a given zener diode is temperature dependent, it is necessary to determine junction temperature under any set of operating conditions in order to calculate its value. The following procedure is recommended:

Lead Temperature, T_L , should be determined from:

$$T_L = \theta_{LA} P_D + T_A.$$

θ_{LA} is the lead-to-ambient thermal resistance ($^\circ\text{C}/\text{W}$) and P_D is the power dissipation. The value for θ_{LA} will vary and depends on the device mounting method. θ_{LA} is generally 30 to $40^\circ\text{C}/\text{W}$ for the various clips and tie points in common use and for printed circuit board wiring.

The temperature of the lead can also be measured using a thermocouple placed on the lead as close as possible to the tie point. The thermal mass connected to the tie point is normally large enough so that it will not significantly respond to heat surges generated in the diode as a result of pulsed operation once steady-state conditions are achieved. Using the measured value of T_L , the junction temperature may be determined by:

$$T_J = T_L + \Delta T_{JL}.$$

ΔT_{JL} is the increase in junction temperature above the lead temperature and may be found from Figure 2 for dc power:

$$\Delta T_{JL} = \theta_{JL} P_D.$$

For worst-case design, using expected limits of I_Z , limits of P_D and the extremes of $T_J(\Delta T_J)$ may be estimated. Changes in voltage, V_Z , can then be found from:

$$\Delta V = \theta_{VZ} T_J.$$

θ_{VZ} , the zener voltage temperature coefficient, is found from Figures 4 and 5.

Under high power-pulse operation, the zener voltage will vary with time and may also be affected significantly by the zener resistance. For best regulation, keep current excursions as low as possible.

Surge limitations are given in Figure 7. They are lower than would be expected by considering only junction temperature, as current crowding effects cause temperatures to be extremely high in small spots, resulting in device degradation should the limits of Figure 7 be exceeded.

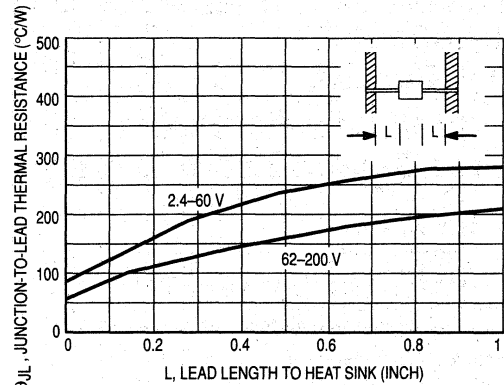

Figure 2. Typical Thermal Resistance

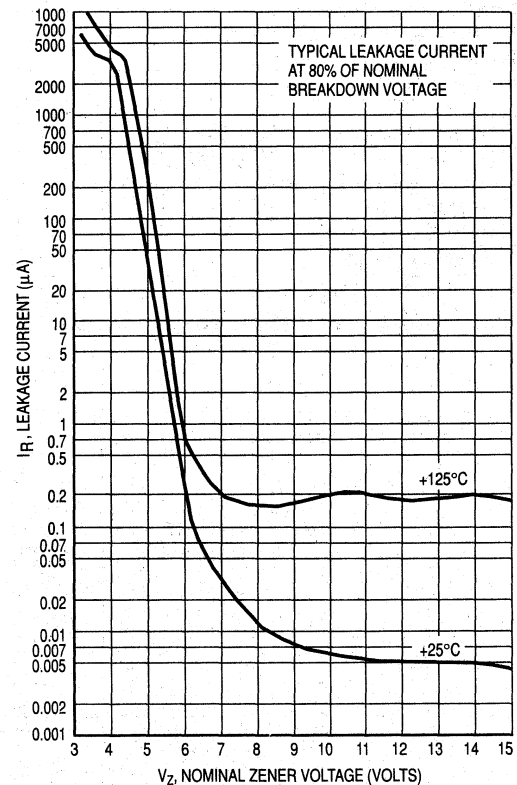

Figure 3. Typical Leakage Current

4

4.2

GENERAL DATA — 500 mW DO-35 GLASS

TEMPERATURE COEFFICIENTS

(-55°C to +150°C temperature range; 90% of the units are in the ranges indicated.)

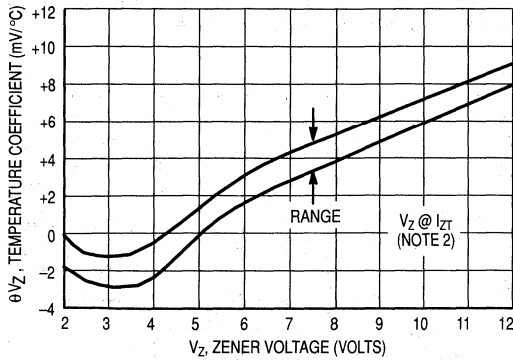

Figure 4a. Range for Units to 12 Volts

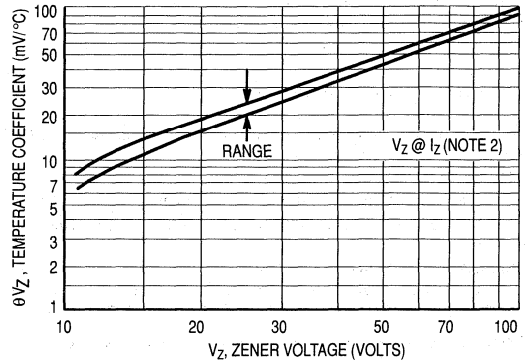

Figure 4b. Range for Units 12 to 100 Volts

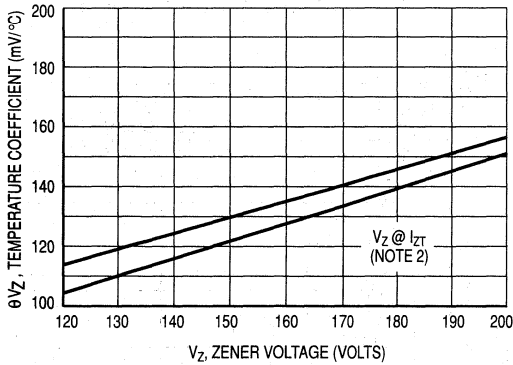

Figure 4c. Range for Units 120 to 200 Volts

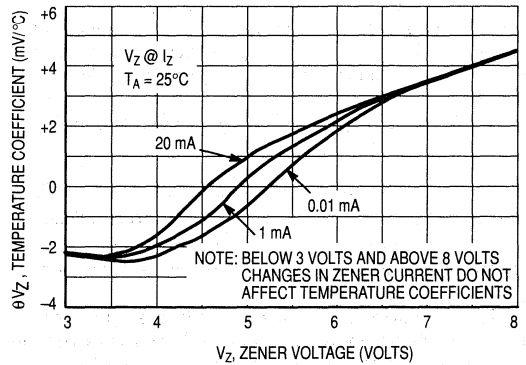

Figure 5. Effect of Zener Current

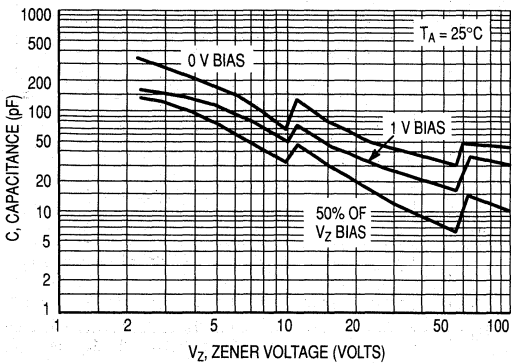

Figure 6a. Typical Capacitance 2.4–100 Volts

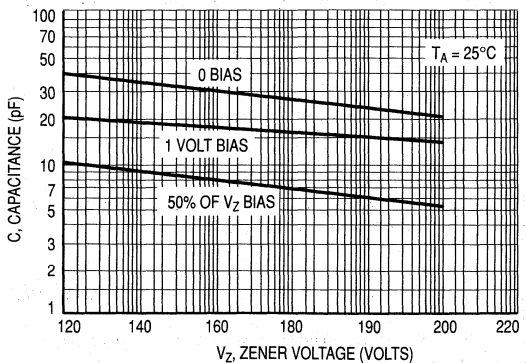

Figure 6b. Typical Capacitance 120–200 Volts

4

4.2

GENERAL DATA — 500 mW DO-35 GLASS

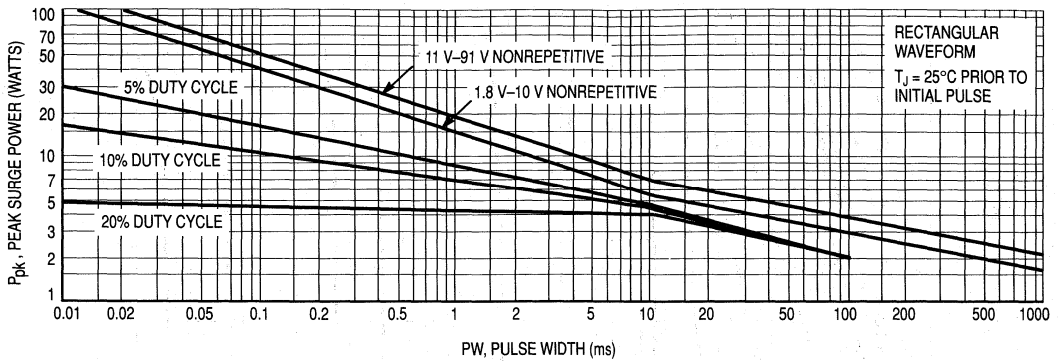

Figure 7a. Maximum Surge Power 1.8-91 Volts

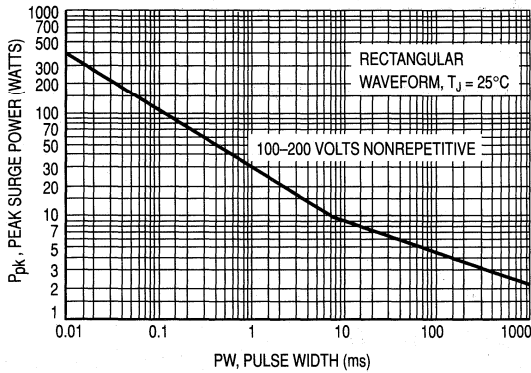

Figure 7b. Maximum Surge Power DO-204AH 100-200 Volts

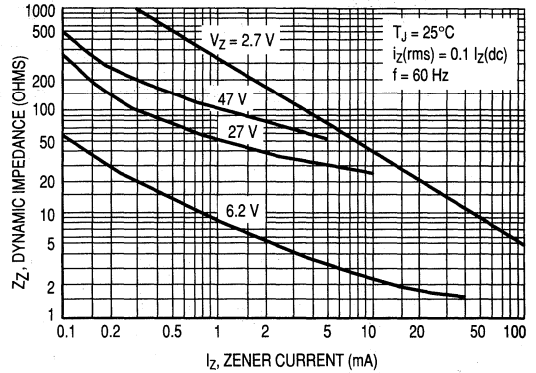

Figure 8. Effect of Zener Current on Zener Impedance

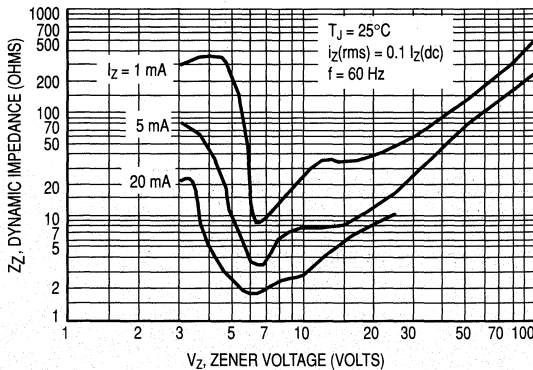

Figure 9. Effect of Zener Voltage on Zener Impedance

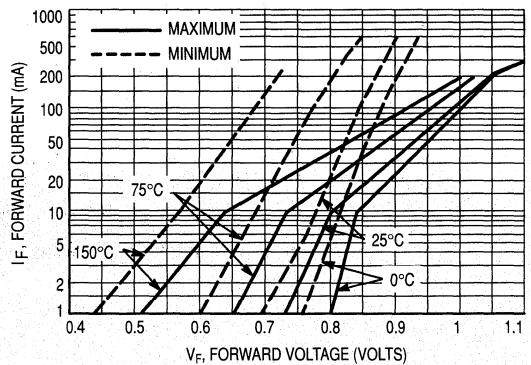

Figure 10. Typical Forward Characteristics

4

4.2

GENERAL DATA — 500 mW DO-35 GLASS

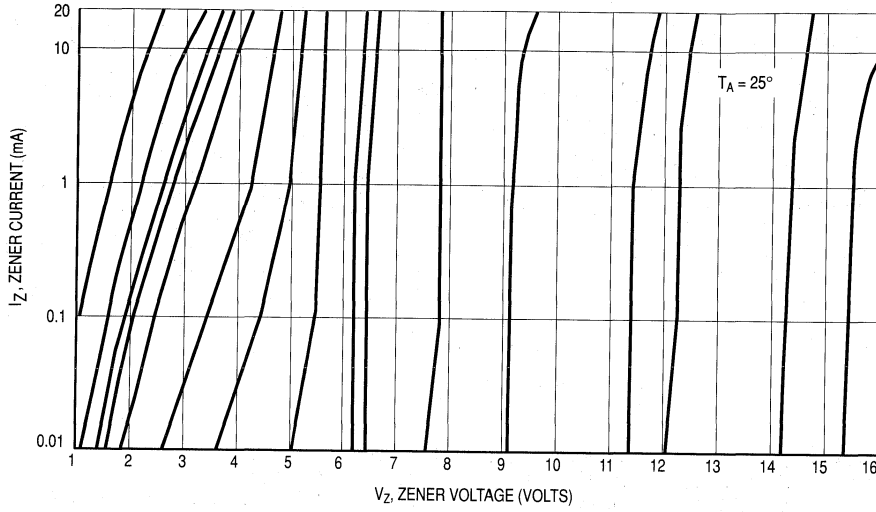

Figure 11. Zener Voltage versus Zener Current — $V_Z = 1$ thru 16 Volts

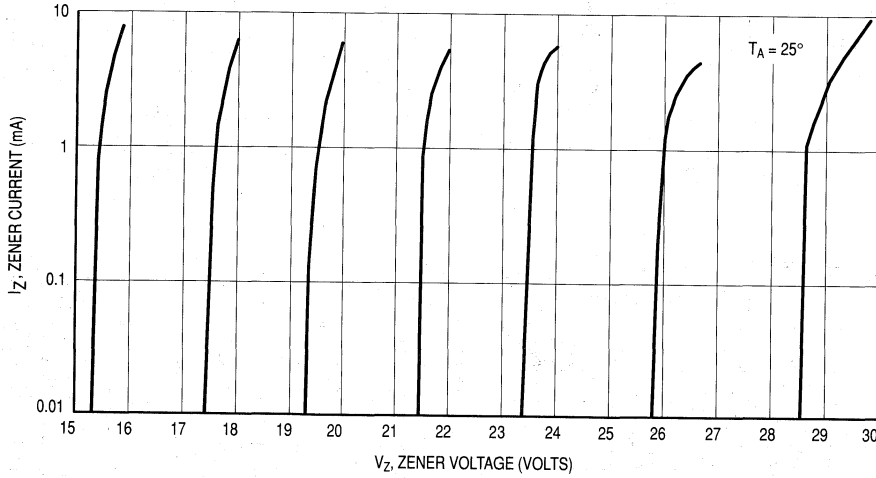

Figure 12. Zener Voltage versus Zener Current — $V_Z = 15$ thru 30 Volts

GENERAL DATA — 500 mW DO-35 GLASS

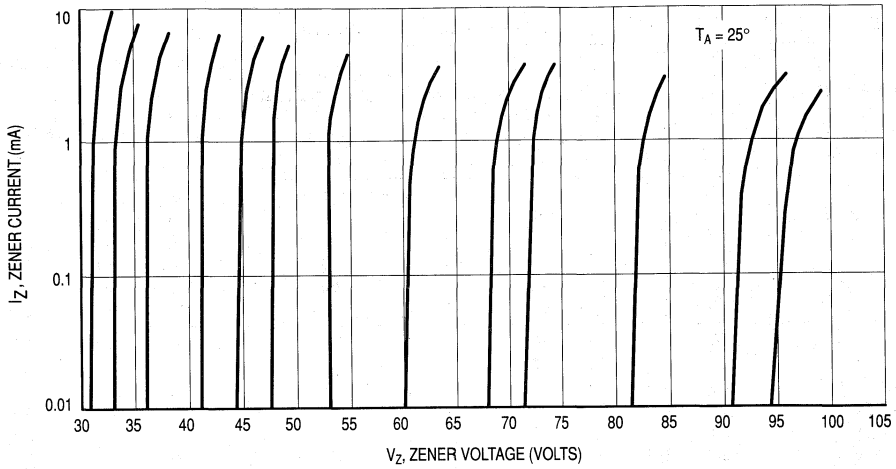

Figure 13. Zener Voltage versus Zener Current — $V_Z = 30$ thru 105 Volts

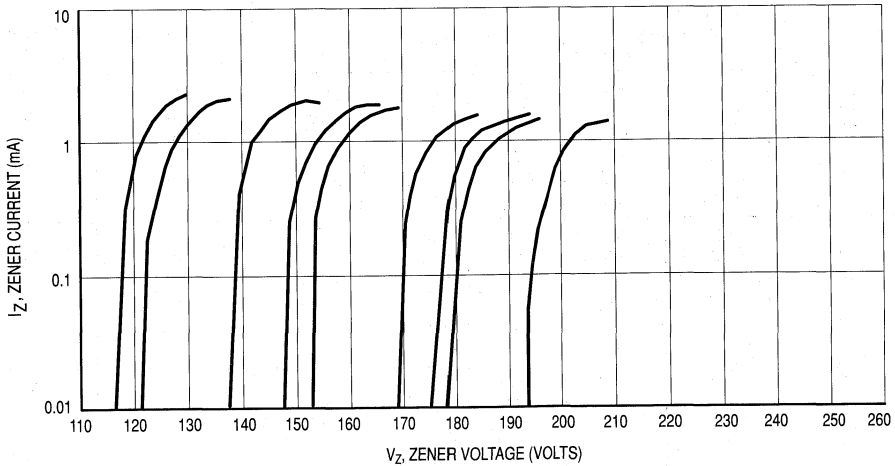

Figure 14. Zener Voltage versus Zener Current — $V_Z = 110$ thru 220 Volts

1N746A thru 1N759A, 1N957B thru 1N992B, 1N4370A thru 1N4372A

ELECTRICAL CHARACTERISTICS (T _A = 25°C, V _F = 1.5 V Max at 200 mA for all types)						
Type Number (Note 1)	Nominal Zener Voltage V _Z @ I _{ZT} (Note 2) Volts	Test Current I _{ZT} mA	Maximum Zener Impedance Z _{ZT} @ I _{ZT} (Note 3) Ohms	Maximum DC Zener Current I _{ZM} (Note 4) mA	Maximum Reverse Leakage Current	
					T _A = 25°C I _R @ V _R = 1 V μA	T _A = 150°C I _R @ V _R = 1 V μA
1N4370A	2.4	20	30	150	100	200
1N4371A	2.7	20	30	135	75	150
1N4372A	3	20	29	120	50	100
1N746A	3.3	20	28	110	10	30
1N747A	3.6	20	24	100	10	30
1N748A	3.9	20	23	95	10	30
1N749A	4.3	20	22	85	2	30
1N750A	4.7	20	19	75	2	30
1N751A	5.1	20	17	70	1	20
1N752A	5.6	20	11	65	1	20
1N753A	6.2	20	7	60	0.1	20
1N754A	6.8	20	5	55	0.1	20
1N755A	7.5	20	6	50	0.1	20
1N756A	8.2	20	8	45	0.1	20
1N757A	9.1	20	10	40	0.1	20
1N758A	10	20	17	35	0.1	20
1N759A	12	20	30	30	0.1	20

4

4.2

Type Number (Note 1)	Nominal Zener Voltage V _Z (Note 2) Volts	Test Current I _{ZT} mA	Maximum Zener Impedance (Note 3)			Maximum DC Zener Current I _{ZM} (Note 4) mA	Maximum Reverse Current	
			Z _{ZT} @ I _{ZT} Ohms	Z _{ZK} @ I _{ZK} Ohms	I _{ZK} mA		I _R Maximum μA	Test Voltage V _R Vdc
1N957B	6.8	18.5	4.5	700	1	47	150	5.2
1N958B	7.5	16.5	5.5	700	0.5	42	75	5.7
1N959B	8.2	15	6.5	700	0.5	38	50	6.2
1N960B	9.1	14	7.5	700	0.5	35	25	6.9
1N961B	10	12.5	8.5	700	0.25	32	10	7.6
1N962B	11	11.5	9.5	700	0.25	28	5	8.4
1N963B	12	10.5	11.5	700	0.25	26	5	9.1
1N964B	13	9.5	13	700	0.25	24	5	9.9
1N965B	15	8.5	16	700	0.25	21	5	11.4
1N966B	16	7.8	17	700	0.25	19	5	12.2
1N967B	18	7	21	750	0.25	17	5	13.7
1N968B	20	6.2	25	750	0.25	15	5	15.2
1N969B	22	5.6	29	750	0.25	14	5	16.7
1N970B	24	5.2	33	750	0.25	13	5	18.2
1N971B	27	4.6	41	750	0.25	11	5	20.6
1N972B	30	4.2	49	1000	0.25	10	5	22.8
1N973B	33	3.8	58	1000	0.25	9.2	5	25.1
1N974B	36	3.4	70	1000	0.25	8.5	5	27.4
1N975B	39	3.2	80	1000	0.25	7.8	5	29.7
1N976B	43	3	93	1500	0.25	7	5	32.7
1N977B	47	2.7	105	1500	0.25	6.4	5	35.8
1N978B	51	2.5	125	1500	0.25	5.9	5	38.8
1N979B	56	2.2	150	2000	0.25	5.4	5	42.6
1N980B	62	2	185	2000	0.25	4.9	5	47.1

1N746A thru 1N759A, 1N957B thru 1N992B, 1N4370A thru 1N4372A

Type Number (Note 1)	Nominal Zener Voltage V_Z (Note 2) Volts	Test Current I_{ZT} mA	Maximum Zener Impedance (Note 3)			Maximum DC Zener Current I_{ZM} (Note 4) mA	Maximum Reverse Leakage Current	
			Z_{ZT} @ I_{ZT} Ohms	Z_{ZK} @ I_{ZK} Ohms	I_{ZK} mA		I_R Maximum μA	Test Voltage V_R V
1N981B	68	1.8	230	2000	0.25	4.5	5	51.7
1N982B	75	1.7	270	2000	0.25	4.1	5	56
1N983B	82	1.5	330	3000	0.25	3.7	5	62.2
1N984B	91	1.4	400	3000	0.25	3.3	5	69.2
1N985B	100	1.3	500	3000	0.25	3	5	76
1N986B	110	1.1	750	4000	0.25	2.7	5	83.6
1N987B	120	1	900	4500	0.25	2.5	5	91.2
1N988B	130	0.95	1100	5000	0.25	2.3	5	98.8
1N989B	150	0.85	1500	6000	0.25	2	5	114
1N990B	160	0.8	1700	6500	0.25	1.9	5	121.6
1N991B	180	0.68	2200	7100	0.25	1.7	5	136.8
1N992B	200	0.65	2500	8000	0.25	1.5	5	152

NOTE 1. TOLERANCE AND VOLTAGE DESIGNATION

Tolerance Designation

The type numbers shown have tolerance designations as follows:

1N4370A series: $\pm 5\%$ units, C for $\pm 2\%$, D for $\pm 1\%$.

1N746A series: $\pm 5\%$ units, C for $\pm 2\%$, D for $\pm 1\%$.

1N957B series: $\pm 5\%$ units, C for $\pm 2\%$, D for $\pm 1\%$.

NOTE 2. ZENER VOLTAGE (V_Z) MEASUREMENT

Nominal zener voltage is measured with the device junction in thermal equilibrium at the lead temperature of $30^\circ C \pm 1^\circ C$ and 3/8" lead length.

NOTE 3. ZENER IMPEDANCE (Z_Z) DERIVATION

Z_{ZT} and Z_{ZK} are measured by dividing the ac voltage drop across the device by the ac current applied. The specified limits are for $I_Z(ac) = 0.1 I_Z(dc)$ with the ac frequency = 60 Hz.

NOTE 4. MAXIMUM ZENER CURRENT RATINGS (I_{ZM})

Values shown are based on the JEDEC rating of 400 mW. Where the actual zener voltage (V_Z) is known at the operating point, the maximum zener current may be increased and is limited by the derating curve.

4

4.2

1N4678 thru 1N4717

Low level oxide passivated zener diodes for applications requiring extremely low operating currents, low leakage, and sharp breakdown voltage.

- Zener Voltage Specified @ $I_{ZT} = 50 \mu\text{A}$
- Maximum Delta V_Z Given from 10 to 100 μA

ELECTRICAL CHARACTERISTICS ($T_A = 25^\circ\text{C}$, $V_F = 1.5 \text{ V}$ Max at $I_F = 100 \text{ mA}$ for all types)

Type Number (Note 1)	Zener Voltage $V_Z @ I_{ZT} = 50 \mu\text{A}$ Volts			Maximum Reverse Current $I_R \mu\text{A}$ (Note 3)	Test Voltage V_R Volts	Maximum Zener Current $I_{ZM} \text{ mA}$ (Note 2)	Maximum Voltage Change ΔV_Z Volts (Note 4)
	Nom (Note 1)	Min	Max				
1N4678	1.8	1.71	1.89	7.5	1	120	0.7
1N4679	2	1.9	2.1	5	1	110	0.7
1N4680	2.2	2.09	2.31	4	1	100	0.75
1N4681	2.4	2.28	2.52	2	1	95	0.8
1N4682	2.7	2.565	2.835	1	1	90	0.85
1N4683	3	2.85	3.15	0.8	1	85	0.9
1N4684	3.3	3.135	3.465	7.5	1.5	80	0.95
1N4685	3.6	3.42	3.78	7.5	2	75	0.95
1N4686	3.9	3.705	4.095	5	2	70	0.97
1N4687	4.3	4.085	4.515	4	2	65	0.99
1N4688	4.7	4.465	4.935	10	3	60	0.99
⇒ 1N4689	5.1	4.845	5.355	10	3	55	0.97
1N4690	5.6	5.32	5.88	10	4	50	0.96
1N4691	6.2	5.89	6.51	10	5	45	0.95
1N4692	6.8	6.46	7.14	10	5.1	35	0.9
1N4693	7.5	7.125	7.875	10	5.7	31.8	0.75
1N4694	8.2	7.79	8.61	1	6.2	29	0.5
1N4695	8.7	8.265	9.135	1	6.6	27.4	0.1
1N4696	9.1	8.645	9.555	1	6.9	26.2	0.08
1N4697	10	9.5	10.5	1	7.6	24.8	0.1
1N4698	11	10.45	11.55	0.05	8.4	21.6	0.11
1N4699	12	11.4	12.6	0.05	9.1	20.4	0.12
1N4700	13	12.35	13.65	0.05	9.8	19	0.13
1N4701	14	13.3	14.7	0.05	10.6	17.5	0.14
1N4702	15	14.25	15.75	0.05	11.4	16.3	0.15
1N4703	16	15.2	16.8	0.05	12.1	15.4	0.16
1N4704	17	16.15	17.85	0.05	12.9	14.5	0.17
1N4705	18	17.1	18.9	0.05	13.6	13.2	0.18
1N4706	19	18.05	19.95	0.05	14.4	12.5	0.19
1N4707	20	19	21	0.01	15.2	11.9	0.2
1N4708	22	20.9	23.1	0.01	16.7	10.8	0.22
1N4709	24	22.8	25.2	0.01	18.2	9.9	0.24
1N4710	25	23.75	26.25	0.01	19	9.5	0.25
1N4711	27	25.65	28.35	0.01	20.4	8.8	0.27
1N4712	28	26.6	29.4	0.01	21.2	8.5	0.28
1N4713	30	28.5	31.5	0.01	22.8	7.9	0.3
1N4714	33	31.35	34.65	0.01	25	7.2	0.33
1N4715	36	34.2	37.8	0.01	27.3	6.6	0.36
1N4716	39	37.05	40.95	0.01	29.6	6.1	0.39
1N4717	43	40.85	45.15	0.01	32.6	5.5	0.43

4

4.2

⇒ Preferred part

NOTE 1. TOLERANCE AND VOLTAGE DESIGNATION (V_Z)

The type numbers shown have a standard tolerance of $\pm 5\%$ on the nominal Zener voltage, C for $\pm 2\%$, D for $\pm 1\%$.

NOTE 2. MAXIMUM ZENER CURRENT RATINGS (I_{ZM})

Maximum Zener current ratings are based on maximum Zener voltage of the individual units and JEDEC 250 mW rating.

NOTE 3. REVERSE LEAKAGE CURRENT (I_R)

Reverse leakage currents are guaranteed and measured at V_R as shown on the table.

NOTE 4. MAXIMUM VOLTAGE CHANGE (ΔV_Z)

Voltage change is equal to the difference between V_Z at 100 μA and V_Z at 10 μA .

NOTE 5. ZENER VOLTAGE (V_Z) MEASUREMENT

Nominal Zener voltage is measured with the device junction in thermal equilibrium at the lead temperature at $30^\circ\text{C} \pm 1^\circ\text{C}$ and $3/8"$ lead length.

1N5221B thru 1N5281B

ELECTRICAL CHARACTERISTICS ($T_A = 25^\circ\text{C}$ unless otherwise noted. Based on dc measurements at thermal equilibrium; lead length = 3/8"; thermal resistance of heat sink = 30°C/W) $V_F = 1.1$ Max @ $I_F = 200$ mA for all types.

JEDEC Type No. (Note 1)	Nominal Zener Voltage V_Z @ I_{ZT} Volts (Note 2)	Test Current I_{ZT} mA	Max Zener Impedance		Max Reverse Leakage Current		Max Zener Voltage Temperature Coeff. θ_{VZ} (%/°C) (Note 3)
			Z_{ZT} @ I_{ZT} Ohms	Z_{ZK} @ $I_{ZK} = 0.25$ mA Ohms	I_R μA	V_R Volts	
⇒ 1N5221B	2.4	20	30	1200	100	1	-0.085
1N5222B	2.5	20	30	1250	100	1	-0.085
⇒ 1N5223B	2.7	20	30	1300	75	1	-0.08
1N5224B	2.8	20	30	1400	75	1	-0.08
1N5225B	3	20	29	1600	50	1	-0.075
⇒ 1N5226B	3.3	20	28	1600	25	1	-0.07
1N5227B	3.6	20	24	1700	15	1	-0.065
⇒ 1N5228B	3.9	20	23	1900	10	1	-0.06
⇒ 1N5229B	4.3	20	22	2000	5	1	± 0.055
⇒ 1N5230B	4.7	20	19	1900	5	2	± 0.03
⇒ 1N5231B	5.1	20	17	1600	5	2	± 0.03
⇒ 1N5232B	5.6	20	11	1600	5	3	+0.038
⇒ 1N5233B	6	20	7	1600	5	3.5	+0.038
⇒ 1N5234B	6.2	20	7	1000	5	4	+0.045
⇒ 1N5235B	6.8	20	5	750	3	5	+0.05
⇒ 1N5236B	7.5	20	6	500	3	6	+0.058
⇒ 1N5237B	8.2	20	8	500	3	6.5	+0.062
1N5238B	8.7	20	8	600	3	6.5	+0.065
⇒ 1N5239B	9.1	20	10	600	3	7	+0.068
⇒ 1N5240B	10	20	17	600	3	8	+0.075
1N5241B	11	20	22	600	2	8.4	+0.076
⇒ 1N5242B	12	20	30	600	1	9.1	+0.077
⇒ 1N5243B	13	9.5	13	600	0.5	9.9	+0.079
⇒ 1N5244B	14	9	15	600	0.1	10	+0.082
⇒ 1N5245B	15	8.5	16	600	0.1	11	+0.082
⇒ 1N5246B	16	7.8	17	600	0.1	12	+0.083
1N5247B	17	7.4	19	600	0.1	13	+0.084
⇒ 1N5248B	18	7	21	600	0.1	14	+0.085
1N5249B	19	6.6	23	600	0.1	14	+0.086
⇒ 1N5250B	20	6.2	25	600	0.1	15	+0.086
1N5251B	22	5.6	29	600	0.1	17	+0.087
⇒ 1N5252B	24	5.2	33	600	0.1	18	+0.088
1N5253B	25	5	35	600	0.1	19	+0.089
⇒ 1N5254B	27	4.6	41	600	0.1	21	+0.09
1N5255B	28	4.5	44	600	0.1	21	+0.091
⇒ 1N5256B	30	4.2	49	600	0.1	23	+0.091
⇒ 1N5257B	33	3.8	58	700	0.1	25	+0.092
⇒ 1N5258B	36	3.4	70	700	0.1	27	+0.093
1N5259B	39	3.2	80	800	0.1	30	+0.094
1N5260B	43	3	93	900	0.1	33	+0.095
1N5261B	47	2.7	105	1000	0.1	36	+0.095
1N5262B	51	2.5	125	1100	0.1	39	+0.096
1N5263B	56	2.2	150	1300	0.1	43	+0.096
1N5264B	60	2.1	170	1400	0.1	46	+0.097
1N5265B	62	2	185	1400	0.1	47	+0.097

(continued)

⇒ Preferred part

4

4.2

1N5221B thru 1N5281B

ELECTRICAL CHARACTERISTICS — continued ($T_A = 25^\circ\text{C}$ unless otherwise noted. Based on dc measurements at thermal equilibrium; lead length = 3/8"; thermal resistance of heat sink = 30°C/W) $V_F = 1.1$ Max @ $I_F = 200$ mA for all types.

JEDEC Type No. (Note 1)	Nominal Zener Voltage V_Z @ I_{ZT} Volts (Note 2)	Test Current I_{ZT} mA	Max Zener Impedance		Max Reverse Leakage Current		Max Zener Voltage Temperature Coeff. θ_{VZ} (%/°C) (Note 3)
			Z_{ZT} @ I_{ZT} Ohms	Z_{ZK} @ $I_{ZK} = 0.25$ mA Ohms	I_R μA	V_R Volts	
1N5266B	68	1.8	230	1600	0.1	52	+0.097
1N5267B	75	1.7	270	1700	0.1	56	+0.098
1N5268B	82	1.5	330	2000	0.1	62	+0.098
1N5269B	87	1.4	370	2200	0.1	68	+0.099
1N5270B	91	1.4	400	2300	0.1	69	+0.099
1N5271B	100	1.3	500	2600	0.1	76	+0.11
1N5272B	110	1.1	750	3000	0.1	84	+0.11
1N5273B	120	1	900	4000	0.1	91	+0.11
1N5274B	130	0.95	1100	4500	0.1	99	+0.11
1N5275B	140	0.9	1300	4500	0.1	106	+0.11
1N5276B	150	0.85	1500	5000	0.1	114	+0.11
1N5277B	160	0.8	1700	5500	0.1	122	+0.11
1N5278B	170	0.74	1900	5500	0.1	129	+0.11
1N5279B	180	0.68	2200	6000	0.1	137	+0.11
1N5280B	190	0.66	2400	6500	0.1	144	+0.11
1N5281B	200	0.65	2500	7000	0.1	152	+0.11

NOTE 1. TOLERANCE

The JEDEC type numbers shown indicate a tolerance of $\pm 5\%$. For tighter tolerance devices use suffixes "C" for $\pm 2\%$ and "D" for $\pm 1\%$.

NOTE 2. SPECIAL SELECTIONS † AVAILABLE INCLUDE:

1. Nominal zener voltages between those shown.
2. Nominal voltages at non-standard test currents.

NOTE 3. TEMPERATURE COEFFICIENT (θ_{VZ})

Test conditions for temperature coefficient are as follows:

- $I_{ZT} = 7.5$ mA, $T_1 = 25^\circ\text{C}$,
 $T_2 = 125^\circ\text{C}$ (1N5221B through 1N5242B).
- $I_{ZT} = \text{Rated } I_{ZT}$, $T_1 = 25^\circ\text{C}$,
 $T_2 = 125^\circ\text{C}$ (1N5243B through 1N5281B).

Device to be temperature stabilized with current applied prior to reading breakdown voltage at the specified ambient temperature.

NOTE 4. ZENER VOLTAGE (V_Z) MEASUREMENT

Nominal zener voltage is measured with the device junction in thermal equilibrium at the lead temperature of $30^\circ\text{C} \pm 1^\circ\text{C}$ and 3/8" lead length.

NOTE 5. ZENER IMPEDANCE (Z_Z) DERIVATION

Z_{ZT} and Z_{ZK} are measured by dividing the ac voltage drop across the device by the ac current applied. The specified limits are for $I_Z(\text{ac}) = 0.1$ I_Z(dc) with the ac frequency = 60 Hz.

† For more information on special selections contact your nearest Motorola representative.

4

4.2

1N5985B thru 1N6025B

*ELECTRICAL CHARACTERISTICS (T _L = 30°C unless otherwise noted.) (V _F = 1.5 Volts Max @ I _F = 100 mAdc for all types.)							
Motorola Type Number (Note 1)	Nominal Zener Voltage V _Z @ I _{ZT} Volts (Notes 2 & 5)	Test Current I _{ZT} mA	Max Zener Impedance (Note 4)		Max Reverse Leakage Current		Max DC Zener Current I _{ZM} (Note 3)
			Z _{ZT} @ I _{ZT} Ohms	Z _{ZK} @ I _{ZK} = Ohms 0.25 mA	I _R μA	@ V _R Volts	
1N5985B	2.4	5	100	1800	100	1	208
1N5986B	2.7	5	100	1900	75	1	185
1N5987B	3	5	95	2000	50	1	167
⇒ 1N5988B	3.3	5	95	2200	25	1	152
1N5989B	3.6	5	90	2300	15	1	139
1N5990B	3.9	5	90	2400	10	1	128
1N5991B	4.3	5	88	2500	5	1	116
1N5992B	4.7	5	70	2200	3	1.5	106
⇒ 1N5993B	5.1	5	50	2050	2	2	98
⇒ 1N5994B	5.6	5	25	1800	2	3	89
1N5995B	6.2	5	10	1300	1	4	81
1N5996B	6.8	5	8	750	1	5.2	74
1N5997B	7.5	5	7	600	0.5	6	67
⇒ 1N5998B	8.2	5	7	600	0.5	6.5	61
1N5999B	9.1	5	10	600	0.1	7	55
1N6000B	10	5	15	600	0.1	8	50
1N6001B	11	5	18	600	0.1	8.4	45
1N6002B	12	5	22	600	0.1	9.1	42
1N6003B	13	5	25	600	0.1	9.9	38
1N6004B	15	5	32	600	0.1	11	33
1N6005B	16	5	36	600	0.1	12	31
1N6006B	18	5	42	600	0.1	14	28
⇒ 1N6007B	20	5	48	600	0.1	15	25
1N6008B	22	5	55	600	0.1	17	23
1N6009B	24	5	62	600	0.1	18	21
1N6010B	27	5	70	600	0.1	21	19
1N6011B	30	5	78	600	0.1	23	17
1N6012B	33	5	88	700	0.1	25	15
1N6013B	36	5	95	700	0.1	27	14
1N6014B	39	2	130	800	0.1	30	13
1N6015B	43	2	150	900	0.1	33	12
1N6016B	47	2	170	1000	0.1	36	11
1N6017B	51	2	180	1300	0.1	39	9.8
1N6018B	56	2	200	1400	0.1	43	8.9
1N6019B	62	2	225	1400	0.1	47	8
1N6020B	68	2	240	1600	0.1	52	7.4
1N6021B	75	2	265	1700	0.1	56	6.7
1N6022B	82	2	280	2000	0.1	62	6.1
1N6023B	91	2	300	2300	0.1	69	5.5
1N6024B	100	1	500	2600	0.1	76	5
1N6025B	110	1	650	3000	0.1	84	4.5

⇒ Preferred part

*Indicates JEDEC Registered Data

NOTE 1. TOLERANCE AND VOLTAGE DESIGNATION

Tolerance designation — Device tolerances of ±5% are indicated by a "B" suffix, ±2% by a "C" suffix, ±1% by a "D" suffix.

NOTE 2. SPECIAL SELECTIONS AVAILABLE INCLUDE:

(a) Nominal Zener voltages between those shown. Contact your nearest Motorola representative.

NOTE 3.

This data was calculated using nominal voltages. The maximum current handling capability on a worst case basis is limited by the actual zener voltage at the operating point and the power derating curve.

NOTE 4.

Z_{ZT} and Z_{ZK} are measured by dividing the ac voltage drop across the device by the ac current applied. The specified limits are for I_Z(ac) = 0.1 I_Z(dc) with the ac frequency = 1.0 kHz.

NOTE 5.

Nominal Zener Voltage (V_Z) is measured with the device junction in thermal equilibrium at the lead temperature of 30°C ±1°C and 3/8" lead length.

4

4.2

BZX55C2V4 thru BZX55C91

ELECTRICAL CHARACTERISTICS ($T_L = 30^\circ\text{C}$ unless otherwise noted.) ($V_F = 1.3$ Volts Max, $I_F = 100$ mAdc for all types.)

Motorola Type Number	V_{ZT} at I_{ZT} (V)		Max Zener Impedance (Note 3) Z_{ZT} @ I_{ZT} (Ohms) Max	I_{ZT} (mA)	Max Reverse Leakage Current I_R at V_R (μA)		V_R (V)	I_{ZM} (mA) (Note 2)
	Min (Note 1)	Max (Note 1)			T_{amb} 25°C Max	T_{amb} 125°C Max		
BZX55C2V4	2.28	2.56	85	5	50	100	1	155
BZX55C2V7	2.5	2.9	85	5	10	50	1	135
BZX55C3V0	2.8	3.2	85	5	4	40	1	125
BZX55C3V3	3.1	3.5	85	5	2	40	1	115
BZX55C3V6	3.4	3.8	85	5	2	40	1	105
BZX55C3V9	3.7	4.1	85	5	2	40	1	95
BZX55C4V3	4	4.6	75	5	1	20	1	90
BZX55C4V7	4.4	5	60	5	0.5	10	1	85
BZX55C5V1	4.8	5.4	35	5	0.1	2	1	80
BZX55C5V6	5.2	6	25	5	0.1	2	1	70
BZX55C6V2	5.8	6.6	10	5	0.1	2	2	64
BZX55C6V8	6.4	7.2	8	5	0.1	2	3	58
BZX55C7V5	7	7.9	7	5	0.1	2	5	53
BZX55C8V2	7.7	8.7	7	5	0.1	2	6	47
BZX55C9V1	8.5	9.6	10	5	0.1	2	7	43
BZX55C10	9.4	10.6	15	5	0.1	2	7.5	40
BZX55C11	10.4	11.6	20	5	0.1	2	8.5	36
BZX55C12	11.4	12.7	20	5	0.1	2	9	32
BZX55C13	12.4	14.1	26	5	0.1	2	10	29
BZX55C15	13.8	15.6	30	5	0.1	2	11	27
BZX55C16	15.3	17.1	40	5	0.1	2	12	24
BZX55C18	16.8	19.1	50	5	0.1	2	14	21
BZX55C20	18.8	21.1	55	5	0.1	2	15	20
BZX55C22	20.8	23.3	55	5	0.1	2	17	18
BZX55C24	22.8	25.6	80	5	0.1	2	18	16
BZX55C27	25.1	28.9	80	5	0.1	2	20	14
BZX55C30	28	32	80	5	0.1	2	22	13
BZX55C33	31	35	80	5	0.1	2	24	12
BZX55C36	34	38	80	5	0.1	2	27	11
BZX55C39	37	41	90	2.5	0.1	5	28	10
BZX55C43	40	46	90	2.5	0.1	5	32	9.2
BZX55C47	44	50	110	2.5	0.1	5	35	8.5
BZX55C51	48	54	125	2.5	0.1	10	38	7.8
BZX55C56	52	60	135	2.5	0.1	10	42	7
BZX55C62	58	66	150	2.5	0.1	10	47	6.4
BZX55C68	64	72	160	2.5	0.1	10	51	5.9
BZX55C75	70	80	170	2.5	0.1	10	56	5.3
BZX55C82	77	87	200	2.5	0.1	10	62	4.8
BZX55C91	85	96	250	1	0.1	10	69	4.3

NOTE 1. TOLERANCE AND VOLTAGE DESIGNATION

Tolerance designation — The type numbers listed have zener voltage min/max limits as shown. Device tolerance of $\pm 2\%$ are indicated by a "B" instead of a "C". Zener voltage is measured with the device junction in thermal equilibrium at the lead temperature of $30^\circ\text{C} \pm 1^\circ\text{C}$ and $3/8"$ lead length.

NOTE 2.

This data was calculated using nominal voltages. The maximum current handling capability on a worst case basis is limited by the actual zener voltage at the operating point and the power derating curve.

NOTE 3.

Z_{ZT} and Z_{ZK} are measured by dividing the ac voltage drop across the device by the ac current applied. The specified limits are for $I_{Z(ac)} = 0.1 I_{Z(dc)}$ with the ac frequency = 1.0 kHz.

BZX79C2V4 thru BZX79C200

*ELECTRICAL CHARACTERISTICS ($T_L = 30^\circ\text{C}$ unless otherwise noted.) ($V_F = 1.5$ Volts Max @ $I_F = 100$ mAdc for all types.)									
Device Type (Note 2)	Zener Voltage (Note 1) (Note 4)			Impedance (Ohm) @ I_{ZT} $f = 1000$ Hz	Leakage Current (μA)		Temp. Coefficient (Typical) (mV/ $^\circ\text{C}$)		Capacitance (Typical) (pF)
	Min	Max	$I_{ZT} =$ (mA)	Max (Note 3)	Max	@ $V_R =$ (Volt)	Min	Max	$V_R = 0,$ $f = 1.0$ MHz
BZX79C2V4	2.2	2.6	5	100	100	1	-3.5	0	255
BZX79C2V7	2.5	2.9	5	100	75	1	-3.5	0	230
BZX79C3V0	2.8	3.2	5	95	50	1	-3.5	0	215
BZX79C3V3	3.1	3.5	5	95	25	1	-3.5	0	200
BZX79C3V6	3.4	3.8	5	90	15	1	-3.5	0	185
BZX79C3V9	3.7	4.1	5	90	10	1	-3.5	+0.3	175
BZX79C4V3	4	4.6	5	90	5	1	-3.5	+1	160
BZX79C4V7	4.4	5	5	80	3	2	-3.5	+0.2	130
BZX79C5V1	4.8	5.4	5	60	2	2	-2.7	+1.2	110
BZX79C5V6	5.2	6	5	40	1	2	-2	+2.5	95
BZX79C6V2	5.8	6.6	5	10	3	4	0.4	3.7	90
BZX79C6V8	6.4	7.2	5	15	2	4	1.2	4.5	85
BZX79C7V5	7	7.9	5	15	1	5	2.5	5.3	80
BZX79C8V2	7.7	8.7	5	15	0.7	5	3.2	6.2	75
BZX79C9V1	8.5	9.6	5	15	0.5	6	3.8	7	70
BZX79C10	9.4	10.6	5	20	0.2	7	4.5	8	70
BZX79C11	10.4	11.6	5	20	0.1	8	5.4	9	65
BZX79C12	11.4	12.7	5	25	0.1	8	6	10	65
BZX79C13	12.4	14.1	5	30	0.1	8	7	11	60
BZX79C15	13.8	15.6	5	30	0.05	10.5	9.2	13	55
BZX79C16	15.3	17.1	5	40	0.05	11.2	10.4	14	52
BZX79C18	16.8	19.1	5	45	0.05	12.6	12.9	16	47
BZX79C20	18.8	21.2	5	55	0.05	14	14.4	18	36
BZX79C22	20.8	23.3	5	55	0.05	15.4	16.4	20	34
BZX79C24	22.8	25.6	5	70	0.05	16.8	18.4	22	33
BZX79C27	25.1	28.9	2	80	0.05	18.9		23.5	30
BZX79C30	28	32	2	80	0.05	21		26	27
BZX79C33	31	35	2	80	0.05	23.1		29	25
BZX79C36	34	38	2	90	0.05	25.2		31	23
BZX79C39	37	41	2	130	0.05	27.3		34	21
BZX79C43	40	46	2	150	0.05	30.1		37	21
BZX79C47	44	50	2	170	0.05	32.9		40	19
BZX79C51	48	54	2	180	0.05	35.7		44	19
BZX79C56	52	60	2	200	0.05	39.2		47	18
BZX79C62	58	66	2	215	0.05	43.4		51	17
BZX79C68	64	72	2	240	0.05	47.6		56	17
BZX79C75	70	79	2	255	0.05	52.5		60	16.5
BZX79C82	77	87	2	280	0.1	62	46	95	29
BZX79C91	85	96	2	300	0.1	69	51	107	28
BZX79C100	94	106	1	500	0.1	76	57	119	27
BZX79C110	104	116	1	650	0.1	84	63	131	26
BZX79C120	114	127	1	800	0.1	91	69	144	24
BZX79C130	124	141	1	950	0.1	99	75	158	23
BZX79C150	138	156	1	1250	0.1	114	87	185	21
BZX79C160	153	171	1	1400	0.1	122	93	200	20
BZX79C180	168	191	1	1700	0.1	137	105	228	18
BZX79C200	188	212	1	2000	0.1	152	120	255	17

NOTE 1. Zener voltage is measured under pulse conditions such that T_J is no more than 2°C above T_A .

NOTE 2. TOLERANCE AND VOLTAGE DESIGNATION

Tolerance designation — The type numbers listed have zener voltage min/max limits as shown. Device tolerances of $\pm 2\%$ are indicated by a "B" instead of a "C," and $\pm 1\%$ by "A."

NOTE 3. Z_{ZT} is measured by dividing the ac voltage drop across the device by the ac current applied. The specified limits are for $I_{ZT}(\text{ac}) = 0.1 I_{ZT}(\text{dc})$ with the ac frequency = 1.0 kHz.

4

4.2

BZX83C2V7 thru BZX83C33, M-ZPD2.7 thru M-ZPD33

ELECTRICAL CHARACTERISTICS (at $T_A = 25^\circ\text{C}$) Motorola ZPD and BZX83C series. Forward Voltage $V_F = 1$ Volt Max at $I_F = 50$ mA.											
Device Type		Zener Voltage (Note 1) at $I_{ZT} = 5.0$ mA			Impedance (Ω) Max (Note 2)			Typ. Temp. Coeff. at I_{ZT} % per $^\circ\text{C}$	V _R Min V		
		Nominal	Min	Max	at I_{ZT}	at $I_Z = 1$ mA			BZX83	ZPD	at I_R
						BZX83	ZPD				
BZX83C2V7	ZPD2.7	2.7	2.5	2.9	85	600	500	-0.09...-0.04	1	—	100 μA
BZX83C3V0	ZPD3.0	3	2.8	3.2	90	600	500	-0.09...-0.03	1	—	60 μA
BZX83C3V3	ZPD3.3	3.3	3.1	3.5	90	600	500	-0.08...-0.03	1	—	30 μA
BZX83C3V6	ZPD3.6	3.6	3.4	3.8	90	600	500	-0.08...-0.03	1	—	20 μA
BZX83C3V9	ZPD3.9	3.9	3.7	4.1	85	600	500	-0.07...-0.03	1	—	10 μA
BZX83C4V3	ZPD4.3	4.3	4	4.6	80	600	500	-0.06...-0.01	1	—	5 μA
BZX83C4V7	ZPD4.7	4.7	4.4	5	78	600	500	-0.05...+0.02	1	—	2 μA
BZX83C5V1	ZPD5.1	5.1	4.8	5.4	60	550	480	-0.03...+0.04	0.8	—	100 nA
BZX83C5V6	ZPD5.6	5.6	5.2	6	40	450	400	-0.02...+0.06	1	—	100 nA
BZX83C6V2	ZPD6.2	6.2	5.8	6.6	10	200	—	-0.01...+0.07	2	—	100 nA
BZX83C6V8	ZPD6.8	6.8	6.4	7.2	8	150	—	+0.02...+0.07	3	—	100 nA
BZX83C7V5	ZPD7.5	7.5	7	7.9	7	50	—	+0.03...+0.07	5	—	100 nA
BZX83C8V2	ZPD8.2	8.2	7.7	8.7	7	50	—	+0.04...+0.07	6	—	100 nA
BZX83C9V1	ZPD9.1	9.1	8.5	9.6	10	50	—	+0.05...+0.08	7	—	100 nA
BZX83C10	ZPD10	10	9.4	10.6	15	70	—	+0.05...+0.08	7.5	—	100 nA
BZX83C11	ZPD11	11	10.4	11.6	20	70	—	+0.05...+0.09	8.5	—	100 nA
BZX83C12	ZPD12	12	11.4	12.7	20	90	—	+0.06...+0.09	9	—	100 nA
BZX83C13	ZPD13	13	12.4	14.1	25	110	—	+0.07...+0.09	10	—	100 nA
BZX83C15	ZPD15	15	13.8	15.6	30	110	—	+0.07...+0.09	11	—	100 nA
BZX83C16	ZPD16	16	15.3	17.1	40	170	—	+0.08...+0.095	12	—	100 nA
BZX83C18	ZPD18	18	16.8	19.1	50	170	—	+0.08...+0.10	14	—	100 nA
BZX83C20	ZPD20	20	18.8	21.2	55	220	—	+0.08...+0.10	15	—	100 nA
BZX83C22	ZPD22	22	20.8	23.3	55	220	—	+0.08...+0.10	17	—	100 nA
BZX83C24	ZPD24	24	22.8	25.6	80	220	—	+0.08...+0.10	18	—	100 nA
BZX83C27	ZPD27	27	25.1	28.9	80	250	—	+0.08...+0.10	20	—	100 nA
BZX83C30	ZPD30	30	28	32	80	250	—	+0.08...+0.10	22	—	100 nA
BZX83C33	ZPD33	33	31	35	80	250	—	+0.08...+0.10	24	—	100 nA

NOTE 1. Pulse test.

NOTE 2. $f = 1.0$ kHz, $I_{Z(ac)} = 0.1 I_{Z(dc)}$.

MZ4099 thru MZ4104, MZ4614 thru MZ4627

... designed for 250 mW applications requiring low leakage, low impedance. Same as 1N4099 through 1N4104 and 1N4614 through 1N4627 except low noise test omitted.

- Voltage Range from 1.8 to 10 Volts
- Zener Impedance and Zener Voltage Specified for Low-Level Operation at $I_{ZT} = 250 \mu\text{A}$

ELECTRICAL CHARACTERISTICS ($T_A = 25^\circ\text{C}$ unless otherwise specified, $I_{ZT} = 250 \mu\text{A}$ and $V_F = 1 \text{ V Max}$ @ $I_F = 200 \text{ mA}$ for all types)						
Type Number (Note 1)	Nominal Zener Voltage V_Z (Note 2) (Volts)	Max Zener Impedance Z_{ZT} (Note 3) (Ohms)	Max Reverse Current I_R (μA)	@ (Note 5)	Test Voltage V_R (Volts)	Max Zener Current I_{ZM} (Note 4) (mA)
MZ4614	1.8	1200	7.5		1	120
MZ4615	2	1250	5		1	110
MZ4616	2.2	1300	4		1	100
MZ4617	2.4	1400	2		1	95
MZ4618	2.7	1500	1		1	90
MZ4619	3	1600	0.8		1	85
MZ4620	3.3	1650	7.5		1.5	80
MZ4621	3.6	1700	7.5		2	75
MZ4622	3.9	1650	5		2	70
MZ4623	4.3	1600	4		2	65
MZ4624	4.7	1550	10		3	60
MZ4625	5.1	1500	10		3	55
MZ4626	5.6	1400	10		4	50
MZ4627	6.2	1200	10		5	45
MZ4099	6.8	200	10		5.2	35
MZ4100	7.5	200	10		5.7	31.8
MZ4101	8.2	200	1		6.3	29
MZ4102	8.7	200	1		6.7	27.4
MZ4103	9.1	200	1		7	26.2
MZ4104	10	200	1		7.6	24.8

NOTE 1. TOLERANCE AND VOLTAGE DESIGNATION

The type numbers shown have a standard tolerance of $\pm 5\%$ on the nominal zener voltage.

NOTE 2. ZENER VOLTAGE (V_Z) MEASUREMENT

Nominal Zener Voltage is measured with the device junction in the thermal equilibrium with ambient temperature of 25°C .

NOTE 3. ZENER IMPEDANCE (Z_{ZT}) DERIVATION

The zener impedance is derived from the 60 cycle ac voltage, which results when an ac current having an rms value equal to 10% of the dc zener current (I_{ZT}) is superimposed on I_{ZT} .

NOTE 4. MAXIMUM ZENER CURRENT RATINGS (I_{ZM})

Maximum zener current ratings are based on maximum zener voltage of the individual units.

NOTE 5. REVERSE LEAKAGE CURRENT I_R

Reverse leakage currents are guaranteed and are measured at V_R as shown on the table.

NOTE 6. SPECIAL SELECTORS AVAILABLE INCLUDE:

- Nominal Zener voltages between those shown.
- Tighter voltage tolerances. Contact your nearest Motorola representative for more information.

4

4.2

MZ5520B thru MZ5530B

Low Voltage Avalanche Passivated Silicon Oxide Zener Regulator Diodes

... Same as 1N5520B through 1N5530B except low noise test spec omitted.

- Low Maximum Regulation Factor
- Low Zener Impedance
- Low Leakage Current

ELECTRICAL CHARACTERISTICS ($T_A = 25^\circ\text{C}$ unless otherwise specified. Based on dc measurements at thermal equilibrium; $V_F = 1.1$ Max @ $I_F = 200$ mA for all types.)

Motorola Type No. (Note 1)	Nominal Zener Voltage $V_Z @ I_{ZT}$ Volts (Note 2)	Test Current I_{ZT} mAdc	Max Zener Impedance $Z_{ZT} @ I_{ZT}$ Ohms (Note 3)	Max Reverse Leakage Current		Maximum DC Zener Current I_{ZM} mAdc (Note 5)	Regulation Factor ΔV_Z Volts (Note 6)	Low V_Z Current I_{ZL} mAdc
				I_R μAdc (Note 4)	$V_R - \text{Volts}$			
MZ5520B	3.9	20	22	1	1	98	0.85	2.0
MZ5521B	4.3	20	18	3	1.5	88	0.75	2.0
MZ5522B	4.7	10	22	2	2	81	0.6	1.0
MZ5523B	5.1	5	26	2	2.5	75	0.65	0.25
MZ5524B	5.6	3	30	2	3.5	68	0.3	0.25
MZ5525B	6.2	1	30	1	5	61	0.2	0.01
MZ5526B	6.8	1	30	1	6.2	56	0.1	0.01
MZ5527B	7.5	1	35	0.5	6.8	51	0.05	0.01
MZ5528B	8.2	1	40	0.5	7.5	46	0.05	0.01
MZ5529B	9.1	1	45	0.1	8.2	42	0.05	0.01
MZ5530B	10	1	60	0.05	9.1	38	0.1	0.01

NOTE 1. TOLERANCE AND VOLTAGE DESIGNATION

The "B" suffix type numbers listed are $\pm 5\%$ tolerance of nominal V_Z .

NOTE 2. ZENER VOLTAGE (V_Z) MEASUREMENT

Nominal zener voltage is measured with the device junction in thermal equilibrium with ambient temperature of 25°C .

NOTE 3. ZENER IMPEDANCE (Z_Z) DERIVATION

The zener impedance is derived from the 60 Hz ac voltage, which results when an ac current having an rms value equal to 10% of the dc zener current (I_{ZT}) is superimposed on I_{ZT} .

NOTE 4. REVERSE LEAKAGE CURRENT I_R

Reverse leakage currents are guaranteed and are measured at V_R as shown on the table.

NOTE 5. MAXIMUM REGULATOR CURRENT (I_{ZM})

The maximum current shown is based on the maximum voltage of a $\pm 5\%$ type unit, therefore, it applies only to the "B" suffix device. The actual I_{ZM} for any device may not exceed the value of 400 milliwatts divided by the actual V_Z of the device.

NOTE 6. MAXIMUM REGULATION FACTOR (ΔV_Z)

ΔV_Z is the maximum difference between V_Z at I_{ZT} and V_Z at I_{ZL} measured with the device junction in thermal equilibrium.

NOTE 7. SPECIAL SELECTORS AVAILABLE INCLUDE:

- Nominal Zener voltages between those shown.
- Tighter voltage tolerances. Contact your nearest Motorola representative for more information.

SECTION 4.2.4 DATA SHEETS

ZENER VOLTAGE REGULATOR DIODES — continued

Section 4.2.4.1 Axial Leaded — continued

SECTION 4.2.4.1.2 1–1.3 WATT DO-41 GLASS

DATA SHEETS

Devices	Page No.
General Data — 1–1.3 Watt DO-41 Glass	4-2-40
1N4728A thru 1N4764A	4-2-44
BZX85C3V3 thru BZX85C100	4-2-45
M-ZPY3.9 thru M-ZPY100	4-2-46

MULTIPLE PACKAGE QUANTITY (MPQ)
REQUIREMENTS

Package Option	Type No. Suffix	MPQ (Units)
Tape and Reel	RL, RL2 ⁽¹⁾	6K
Tape and Ammo	TA, TA2 ⁽¹⁾	4K

NOTE 1. The "2" suffix refers to 26 mm tape spacing.

*1-1.3 Watt DO-41 Glass
Zener Voltage Regulator Diodes*

**GENERAL DATA APPLICABLE TO ALL SERIES IN
THIS GROUP**

**One Watt Hermetically Sealed Glass
Silicon Zener Diodes**

Specification Features:

- Complete Voltage Range — 3.3 to 100 Volts
- DO-41 Package
- Double Slug Type Construction
- Metallurgically Bonded Construction
- Oxide Passivated Die

Mechanical Characteristics:

CASE: Double slug type, hermetically sealed glass

MAXIMUM LEAD TEMPERATURE FOR SOLDERING PURPOSES: 230°C, 1/16" from case for 10 seconds

FINISH: All external surfaces are corrosion resistant with readily solderable leads

POLARITY: Cathode indicated by color band. When operated in zener mode, cathode will be positive with respect to anode

MOUNTING POSITION: Any

**GENERAL
DATA**

**1-1.3 WATT
DO-41 GLASS**

**1 WATT
ZENER REGULATOR
DIODES
3.3-100 VOLTS**

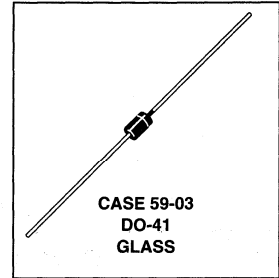

4

MAXIMUM RATINGS				
Rating	Symbol	Value	Unit	
DC Power Dissipation @ $T_A = 50^\circ\text{C}$ Derate above 50°C	P_D	1 6.67	Watt mW/°C	
Operating and Storage Junction Temperature Range	T_J, T_{stg}	-65 to +200	°C	

4.2

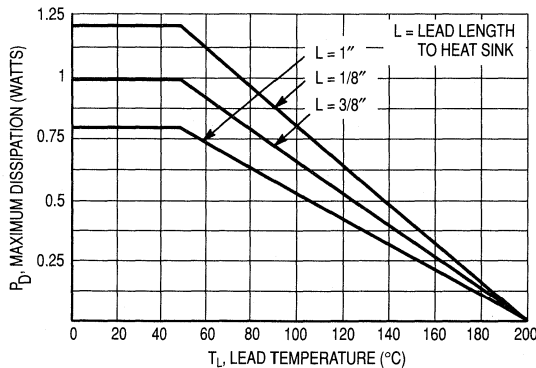

Figure 1. Power Temperature Derating Curve

GENERAL DATA — 1-1.3 WATT DO-41 GLASS

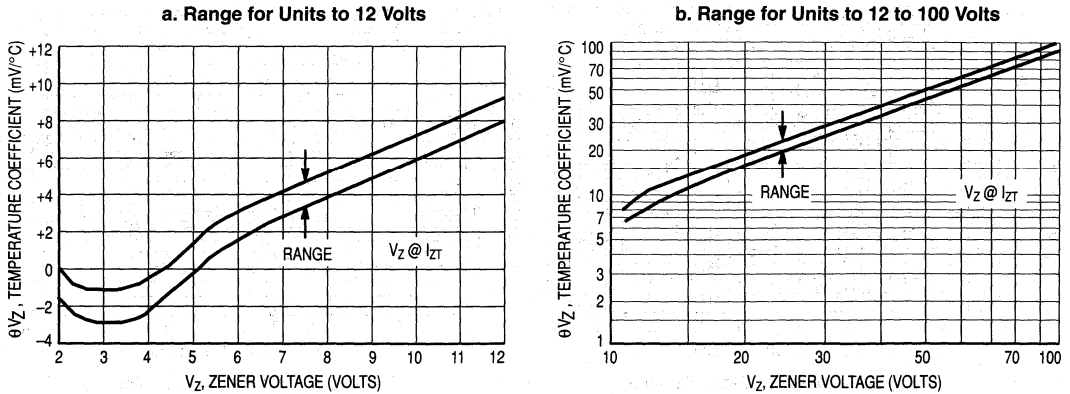

Figure 2. Temperature Coefficients
 (-55°C to +150°C temperature range; 90% of the units are in the ranges indicated.)

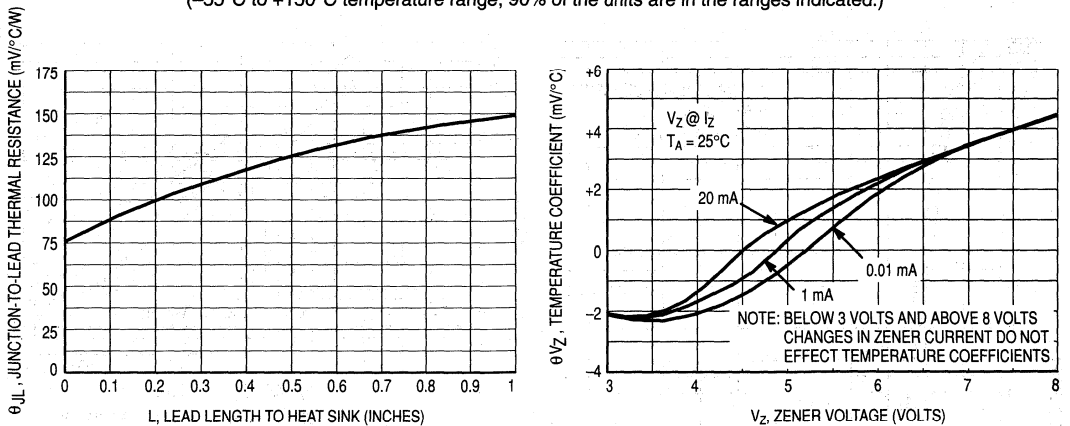

Figure 3. Typical Thermal Resistance versus Lead Length

Figure 4. Effect of Zener Current

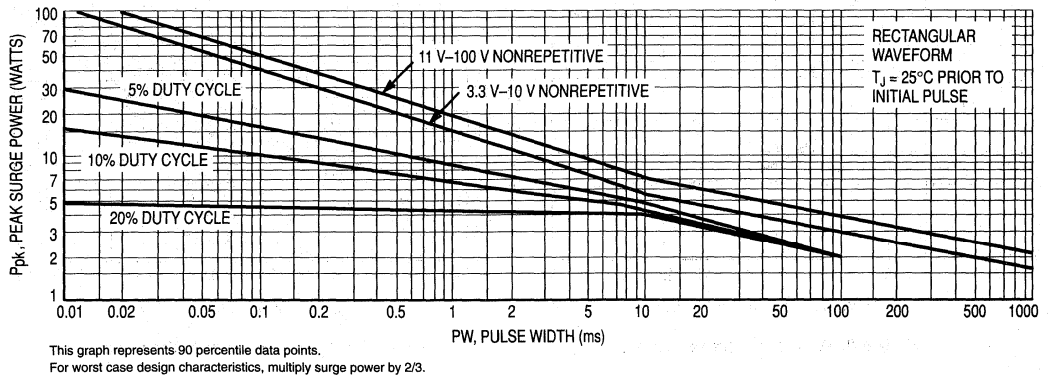

Figure 5. Maximum Surge Power

GENERAL DATA — 1-1.3 WATT DO-41 GLASS

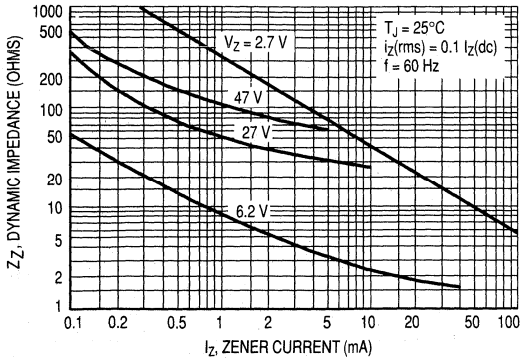

Figure 6. Effect of Zener Current on Zener Impedance

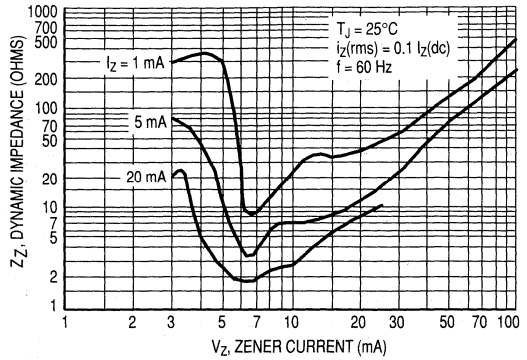

Figure 7. Effect of Zener Voltage on Zener Impedance

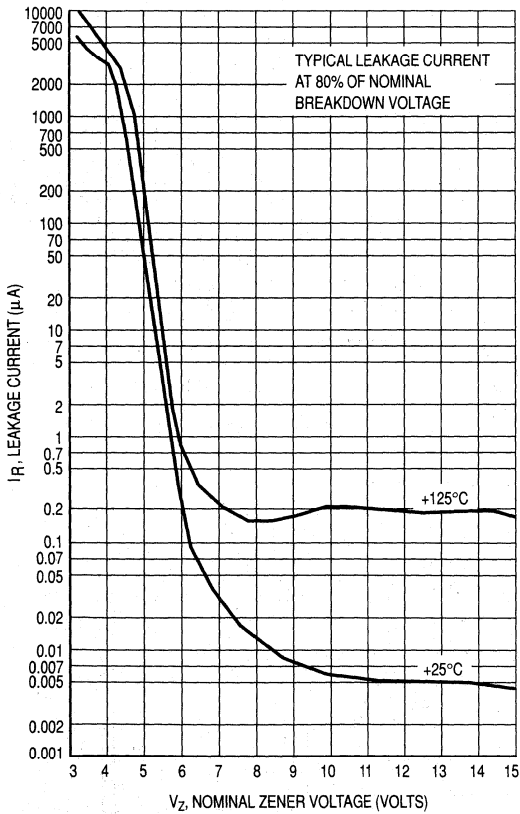

Figure 8. Typical Leakage Current

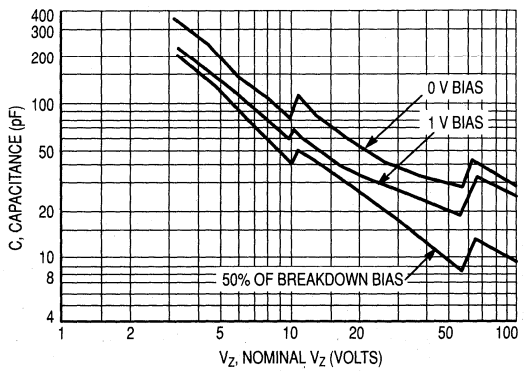

Figure 9. Typical Capacitance versus V_Z

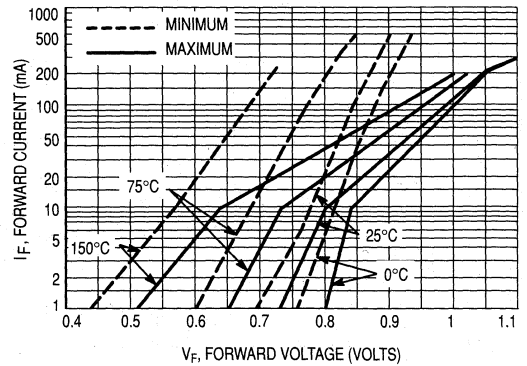

Figure 10. Typical Forward Characteristics

GENERAL DATA — 1-1.3 WATT DO-41 GLASS

APPLICATION NOTE

Since the actual voltage available from a given zener diode is temperature dependent, it is necessary to determine junction temperature under any set of operating conditions in order to calculate its value. The following procedure is recommended:

Lead Temperature, T_L , should be determined from:

$$T_L = \theta_{LA} P_D + T_A$$

θ_{LA} is the lead-to-ambient thermal resistance ($^{\circ}\text{C}/\text{W}$) and P_D is the power dissipation. The value for θ_{LA} will vary and depends on the device mounting method. θ_{LA} is generally 30 to 40 $^{\circ}\text{C}/\text{W}$ for the various clips and tie points in common use and for printed circuit board wiring.

The temperature of the lead can also be measured using a thermocouple placed on the lead as close as possible to the tie point. The thermal mass connected to the tie point is normally large enough so that it will not significantly respond to heat surges generated in the diode as a result of pulsed operation once steady-state conditions are achieved. Using the measured value of T_L , the junction temperature may be determined by:

$$T_J = T_L + \Delta T_{JL}$$

ΔT_{JL} is the increase in junction temperature above the lead

temperature and may be found as follows:

$$\Delta T_{JL} = \theta_{JL} P_D$$

θ_{JL} may be determined from Figure 3 for dc power conditions. For worst-case design, using expected limits of I_Z , limits of P_D and the extremes of T_J (ΔT_J) may be estimated. Changes in voltage, V_Z , can then be found from:

$$\Delta V = \theta_{VZ} \Delta T_J$$

θ_{VZ} , the zener voltage temperature coefficient, is found from Figure 2.

Under high power-pulse operation, the zener voltage will vary with time and may also be affected significantly by the zener resistance. For best regulation, keep current excursions as low as possible.

Surge limitations are given in Figure 5. They are lower than would be expected by considering only junction temperature, as current crowding effects cause temperatures to be extremely high in small spots, resulting in device degradation should the limits of Figure 5 be exceeded.

1N4728A thru 1N4764A

*ELECTRICAL CHARACTERISTICS (T _A = 25°C unless otherwise noted) V _F = 1.2 V Max, I _F = 200 mA for all types.								
JEDEC Type No. (Note 1)	Nominal Zener Voltage V _Z @ I _{ZT} Volts (Notes 2 and 3)	Test Current I _{ZT} mA	Maximum Zener Impedance (Note 4)			Leakage Current		Surge Current @ T _A = 25°C I _S - mA (Note 5)
			Z _{ZT} @ I _{ZT} Ohms	Z _{ZK} @ I _{ZK} Ohms	I _{ZK} mA	I _R μA Max	V _R Volts	
⇒ 1N4728A	3.3	76	10	400	1	100	1	1380
1N4729A	3.6	69	10	400	1	100	1	1260
1N4730A	3.9	64	9	400	1	50	1	1190
⇒ 1N4731A	4.3	58	9	400	1	10	1	1070
⇒ 1N4732A	4.7	53	8	500	1	10	1	970
⇒ 1N4733A	5.1	49	7	550	1	10	1	890
⇒ 1N4734A	5.6	45	5	600	1	10	2	810
⇒ 1N4735A	6.2	41	2	700	1	10	3	730
⇒ 1N4736A	6.8	37	3.5	700	1	10	4	660
1N4737A	7.5	34	4	700	0.5	10	5	605
⇒ 1N4738A	8.2	31	4.5	700	0.5	10	6	550
⇒ 1N4739A	9.1	28	5	700	0.5	10	7	500
⇒ 1N4740A	10	25	7	700	0.25	10	7.6	454
⇒ 1N4741A	11	23	8	700	0.25	5	8.4	414
⇒ 1N4742A	12	21	9	700	0.25	5	9.1	380
⇒ 1N4743A	13	19	10	700	0.25	5	9.9	344
⇒ 1N4744A	15	17	14	700	0.25	5	11.4	304
⇒ 1N4745A	16	15.5	16	700	0.25	5	12.2	285
⇒ 1N4746A	18	14	20	750	0.25	5	13.7	250
⇒ 1N4747A	20	12.5	22	750	0.25	5	15.2	225
1N4748A	22	11.5	23	750	0.25	5	16.7	205
⇒ 1N4749A	24	10.5	25	750	0.25	5	18.2	190
⇒ 1N4750A	27	9.5	35	750	0.25	5	20.6	170
⇒ 1N4751A	30	8.5	40	1000	0.25	5	22.8	150
1N4752A	33	7.5	45	1000	0.25	5	25.1	135
1N4753A	36	7	50	1000	0.25	5	27.4	125
1N4754A	39	6.5	60	1000	0.25	5	29.7	115
1N4755A	43	6	70	1500	0.25	5	32.7	110
1N4756A	47	5.5	80	1500	0.25	5	35.8	95
1N4757A	51	5	95	1500	0.25	5	38.8	90
1N4758A	56	4.5	110	2000	0.25	5	42.6	80
1N4759A	62	4	125	2000	0.25	5	47.1	70
1N4760A	68	3.7	150	2000	0.25	5	51.7	65
1N4761A	75	3.3	175	2000	0.25	5	56	60
1N4762A	82	3	200	3000	0.25	5	62.2	55
1N4763A	91	2.8	250	3000	0.25	5	69.2	50
1N4764A	100	2.5	350	3000	0.25	5	76	45

⇒ Preferred part

*Indicates JEDEC Registered Data.

NOTE 1. TOLERANCE AND TYPE NUMBER DESIGNATION

The JEDEC type numbers listed have a standard tolerance on the nominal zener voltage of ±5%. C for ±2%, D for ±1%.

NOTE 2. SPECIALS AVAILABLE INCLUDE:

Nominal zener voltages between the voltages shown and tighter voltage tolerances.

For detailed information on price, availability, and delivery, contact your nearest Motorola representative.

NOTE 3. ZENER VOLTAGE (V_Z) MEASUREMENT

Motorola guarantees the zener voltage when measured at 90 seconds while maintaining the lead temperature (T_L) at 30°C ± 1°C, 3/8" from the diode body.

NOTE 4. ZENER IMPEDANCE (Z_Z) DERIVATION

The zener impedance is derived from the 60 cycle ac voltage, which results when an ac current having an rms value equal to 10% of the dc zener current (I_{ZT} or I_{ZK}) is superimposed on I_{ZT} or I_{ZK}.

NOTE 5. SURGE CURRENT (I_S) NON-REPETITIVE

The rating listed in the electrical characteristics table is maximum peak, non-repetitive, reverse surge current of 1/2 square wave or equivalent sine wave pulse of 1/120 second duration superimposed on the test current, I_{ZT}, per JEDEC registration; however, actual device capability is as described in Figure 5 of the General Data — DO-41 Glass.

BZX85C3V3 thru BZX85C100

ELECTRICAL CHARACTERISTICS (T _A = 25°C unless otherwise noted.) (V _F = 1.2 V Max, I _F = 200 mA for all types.)									
Type (Note 1)	Zener Voltage V _{ZT} (V) (Notes 2 and 3)		Test Current I _{ZT} (mA)	Zener Impedance Z _Z (ohms) (Note 4)			Leakage Current (μA)		Surge Current T _A = 25°C i _s (mA) (Note 5)
	V _Z Min	V _Z Max		Max at I _{ZT}	Max at I _Z (mA)		V _R (V)	I _R Max	
BZX85C3V3	3.1	3.5	80	20	400	1	1	60	1380
BZX85C3V6	3.4	3.8	60	15	500	1	1	30	1260
BZX85C3V9	3.7	4.1	60	15	500	1	1	5	1190
BZX85C4V3	4	4.6	50	13	500	1	1	3	1070
BZX85C4V7	4.4	5	45	13	600	1	1.5	3	970
BZX85C5V1	4.8	5.4	45	10	500	1	2	1	890
BZX85C5V6	5.2	6	45	7	400	1	2	1	810
BZX85C6V2	5.8	6.6	35	4	300	1	3	1	730
BZX85C6V8	6.4	7.2	35	3.5	300	1	4	1	660
BZX85C7V5	7	7.9	35	3	200	0.5	4.5	1	605
BZX85C8V2	7.7	8.7	25	5	200	0.5	5	1	550
BZX85C9V1	8.5	9.6	25	5	200	0.5	6.5	1	500
BZX85C10	9.4	10.6	25	7	200	0.5	7	0.5	454
BZX85C11	10.4	11.6	20	8	300	0.5	7.7	0.5	414
BZX85C12	11.4	12.7	20	9	350	0.5	8.4	0.5	380
BZX85C13	12.4	14.1	20	10	400	0.5	9.1	0.5	344
BZX85C15	13.8	15.6	15	15	500	0.5	10.5	0.5	304
BZX85C16	15.3	17.1	15	15	500	0.5	11	0.5	285
BZX85C18	16.8	19.1	15	20	500	0.5	12.5	0.5	250
BZX85C20	18.8	21.2	10	24	600	0.5	14	0.5	225
BZX85C22	20.8	23.3	10	25	600	0.5	15.5	0.5	205
BZX85C24	22.8	25.6	10	25	600	0.5	17	0.5	190
BZX85C27	25.1	28.9	8	30	750	0.25	19	0.5	170
BZX85C30	28	32	8	30	1000	0.25	21	0.5	150
BZX85C33	31	35	8	35	1000	0.25	23	0.5	135
BZX85C36	34	38	8	40	1000	0.25	25	0.5	125
BZX85C39	37	41	6	45	1000	0.25	27	0.5	115
BZX85C43	40	46	6	50	1000	0.25	30	0.5	110
BZX85C47	44	50	4	90	1500	0.25	33	0.5	95
BZX85C51	48	54	4	115	1500	0.25	36	0.5	90
BZX85C56	52	60	4	120	2000	0.25	39	0.5	80
BZX85C62	58	66	4	125	2000	0.25	43	0.5	70
BZX85C68	64	72	4	130	2000	0.25	47	0.5	65
BZX85C75	70	80	4	150	2000	0.25	51	0.5	60
BZX85C82	77	87	2.7	200	3000	0.25	56	0.5	55
BZX85C91	85	96	2.7	250	3000	0.25	62	0.5	50
BZX85C100	96	106	2.7	350	3000	0.25	68	0.5	45

NOTE 1. TOLERANCE AND TYPE NUMBER DESIGNATION

The type numbers listed have zener voltage min/max limits as shown. Device tolerance of ±2% are indicated by a "B" instead of "C."

NOTE 2. SPECIALS AVAILABLE INCLUDE:

Nominal zener voltages between the voltages shown and tighter voltage tolerances. For detailed information on price, availability, and delivery, contact your nearest Motorola representative.

NOTE 3. ZENER VOLTAGE (V_Z) MEASUREMENT

V_Z is measured after the test current has been applied to 40 ± 10 msec., while maintaining the lead temperature (T_L) at 30°C ± 1°C, 3/8" from the diode body.

NOTE 4. ZENER IMPEDANCE (Z_Z) DERIVATION

The zener impedance is derived from the 1 kHz cycle ac voltage, which results when an ac current having an rms value equal to 10% of the dc zener current (I_{ZT}) or (I_{ZK}) is superimposed on I_{ZT} or I_{ZK}.

NOTE 5. SURGE CURRENT (i_s) NON-REPETITIVE

The rating listed in the electrical characteristics table is maximum peak, non-repetitive, reverse surge current of 1/2 square wave or equivalent sine wave pulse of 1/120 second duration superimposed on the test current I_{ZT}. However, actual device capability is as described in Figure 5 of General Data DO-41 glass.

4

4.2

M-ZPY3.9 thru M-ZPY100

ELECTRICAL CHARACTERISTICS ($T_A = 25^\circ\text{C}$ unless otherwise noted) $V_F = 1.2\text{ V Max}$, $I_F = 200\text{ mA}$ for all types.

Type No. (Note 1)	Zener Voltage (V) (Notes 2 and 3)		Test Current I_{ZT} (mA)	Zener Impedance (Note 4) $f = 1\text{ kHz (ohms)}$		Blocking Volt Min (V) $I_R = 1\ \mu\text{A}$	Surge Current $T_A = 25^\circ\text{C}$ i_r (mA) (Note 5)
	V_Z Min	V_Z Max		Typ	Max		
MZPY3.9	3.7	4.1	100	4	7	—	1190
MZPY4.3	4	4.6	100	4	7	—	1070
MZPY4.7	4.4	5	100	4	7	—	970
MZPY5.1	4.8	5.4	100	2	5	0.7	890
MZPY5.6	5.2	6	100	1	2	1.5	810
MZPY6.2	5.8	6.6	100	1	2	2	730
MZPY6.8	6.4	7.2	100	1	2	3	660
MZPY7.5	7	7.9	100	1	2	5	605
MZPY8.2	7.7	8.7	100	1	2	6	550
MZPY9.1	8.5	9.6	50	2	4	7	500
MZPY10	9.4	10.6	50	2	4	7.5	454
MZPY11	10.4	11.6	50	3	7	8.5	414
MZPY12	11.4	12.7	50	3	7	9	380
MZPY13	12.4	14.1	50	4	9	10	344
MZPY15	14.2	15.8	50	4	9	11	304
MZPY16	15.3	17.1	25	5	10	12	285
MZPY18	16.8	19.1	25	5	11	14	250
MZPY20	18.8	21.2	25	6	12	15	225
MZPY22	20.8	23.3	25	7	13	17	205
MZPY24	22.8	25.6	25	8	14	18	190
MZPY27	25.1	28.9	25	9	15	20	170
MZPY30	28	32	25	10	20	22.5	150
MZPY33	31	35	25	11	20	25	135
MZPY36	34	38	10	25	60	27	125
MZPY39	37	41	10	30	60	29	115
MZPY43	40	46	10	35	80	32	110
MZPY47	44	50	10	40	80	35	95
MZPY51	48	54	10	45	100	38	90
MZPY56	52	60	10	50	100	42	80
MZPY62	58	66	10	60	130	47	70
MZPY68	64	72	10	65	130	51	65
MZPY75	70	79	10	70	160	56	60
MZPY82	77	88	10	80	160	61	55
MZPY91	85	96	5	120	250	68	50
MZPY100	94	106	5	130	250	75	45

NOTE 1. TOLERANCE AND TYPE NUMBER DESIGNATION

The type numbers listed have zener voltage min/max limits as shown. Device tolerance of $\pm 2\%$ are indicated by a "C" and $\pm 1\%$ by a "D" suffix.

NOTE 2. SPECIALS AVAILABLE INCLUDE:

Nominal zener voltages between the voltages shown and tighter voltage tolerances. For detailed information on price, availability, and delivery, contact your nearest Motorola representative.

NOTE 3. ZENER VOLTAGE (V_Z) MEASUREMENT

V_Z is measured after the test current has been applied to $40 \pm 10\text{ msec.}$, while maintaining the lead temperature (T_L) at $30^\circ\text{C} \pm 1^\circ\text{C}$, $3/8"$ from the diode body.

NOTE 4. ZENER IMPEDANCE (Z_Z) DERIVATION

The zener impedance is derived from the 1 kHz cycle ac voltage, which results when an ac current having an rms value equal to 10% of the dc zener current (I_{ZT}) of (I_{ZK}) is superimposed on I_{ZT} or I_{ZK} .

NOTE 5. SURGE CURRENT (i_r) NON-REPETITIVE

The rating listed in the electrical characteristics table is maximum peak, non-repetitive, reverse surge current of 1/2 square wave or equivalent sine wave pulse of 1/120 second duration superimposed on the test current I_{ZT} , however, actual device capability is as described in Figure 5 of General Data DO-41 glass.

SECTION 4.2.4 DATA SHEETS

ZENER VOLTAGE REGULATOR DIODES — continued

Section 4.2.4.1 Axial Leaded — continued

SECTION 4.2.4.1.3 1-3 WATT DO-41 SURMETIC 30

4

DATA SHEETS

Devices	Page No.
General Data — 1-3 Watt DO-41 Surmetic 30	4-2-48
1N5913B thru 1N5956B	4-2-51
3EZ3.9D5 thru 3EZ400D5	4-2-53
MZD3.9 thru MZD200	4-2-55
MZP4728A thru MZP4764A, 1M110ZS5 thru 1M200ZS5	4-2-56

MULTIPLE PACKAGE QUANTITY (MPQ) REQUIREMENTS

Package Option	Type No. Suffix	MPQ (Units)
Tape and Reel	RL	6K
Tape and Ammo	TA	4K

4.2

*1 to 3 Watt DO-41 Surmetic 30
Zener Voltage Regulator Diodes*

**GENERAL DATA APPLICABLE TO ALL SERIES IN
THIS GROUP**

**1 to 3 Watt Surmetic 30
Silicon Zener Diodes**

... a complete series of 1 to 3 Watt Zener Diodes with limits and operating characteristics that reflect the superior capabilities of silicon-oxide-passivated junctions. All this in an axial-lead, transfer-molded plastic package offering protection in all common environmental conditions.

Specification Features:

- Surge Rating of 98 Watts @ 1 ms
- Maximum Limits Guaranteed On Up To Six Electrical Parameters
- Package No Larger Than the Conventional 1 Watt Package

Mechanical Characteristics:

CASE: Void-free, transfer-molded, thermosetting plastic

FINISH: All external surfaces are corrosion resistant and leads are readily solderable

POLARITY: Cathode indicated by color band. When operated in zener mode, cathode will be positive with respect to anode

MOUNTING POSITION: Any

WEIGHT: 0.4 gram (approx)

**GENERAL
DATA**

**1-3 WATT
DO-41
SURMETIC 30**

**1 TO 3 WATT
ZENER REGULATOR
DIODES
3.3-400 VOLTS**

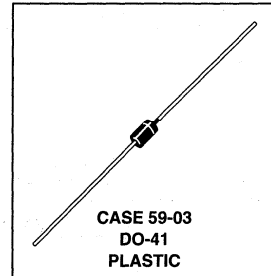

4

MAXIMUM RATINGS			
Rating	Symbol	Value	Unit
DC Power Dissipation @ $T_L = 75^\circ\text{C}$ Lead Length = 3/8" Derate above 75°C	P_D	3	Watts
		24	mW/°C
DC Power Dissipation @ $T_A = 50^\circ\text{C}$ Derate above 50°C	P_D	1 6.67	Watt mW/°C
Operating and Storage Junction Temperature Range	T_J, T_{stg}	- 65 to +200	°C

4.2

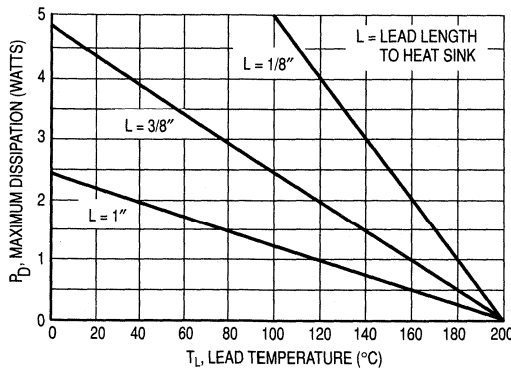

Figure 1. Power Temperature Derating Curve

GENERAL DATA — 1-3 WATT DO-41 SURMETIC 30

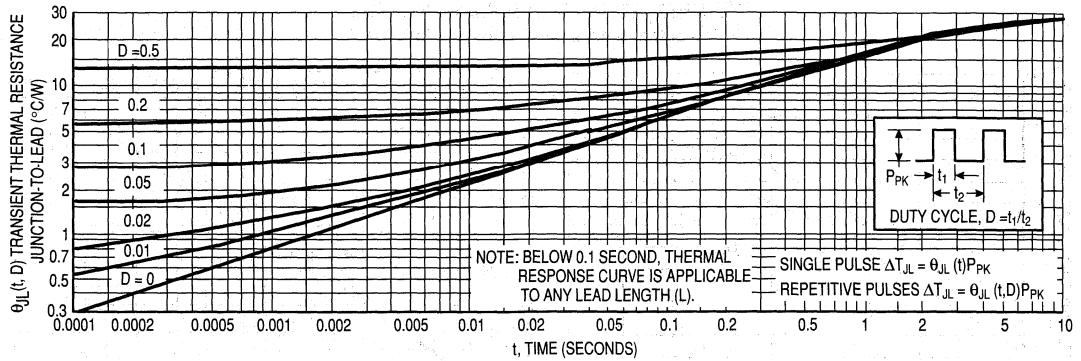

Figure 2. Typical Thermal Response L, Lead Length = 3/8 Inch

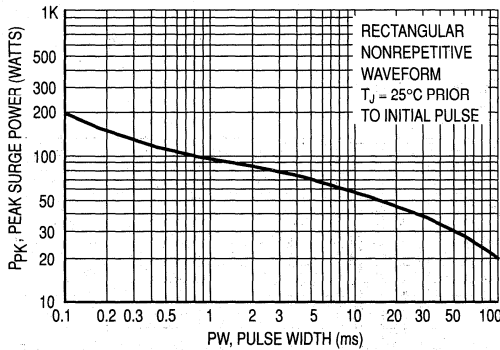

Figure 3. Maximum Surge Power

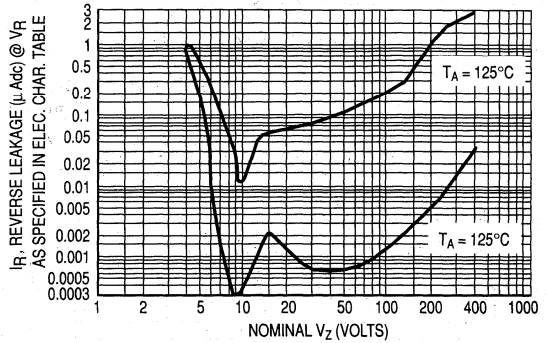

Figure 4. Typical Reverse Leakage

APPLICATION NOTE

Since the actual voltage available from a given zener diode is temperature dependent, it is necessary to determine junction temperature under any set of operating conditions in order to calculate its value. The following procedure is recommended:

Lead Temperature, T_L , should be determined from:

$$T_L = \theta_{LA} P_D + T_A$$

θ_{LA} is the lead-to-ambient thermal resistance ($^{\circ}\text{C}/\text{W}$) and P_D is the power dissipation. The value for θ_{LA} will vary and depends on the device mounting method. θ_{LA} is generally 30–40 $^{\circ}\text{C}/\text{W}$ for the various clips and tie points in common use and for printed circuit board wiring.

The temperature of the lead can also be measured using a thermocouple placed on the lead as close as possible to the tie point. The thermal mass connected to the tie point is normally large enough so that it will not significantly respond to heat surges generated in the diode as a result of pulsed operation once steady-state conditions are achieved. Using the measured value of T_L , the junction temperature may be determined by:

$$T_J = T_L + \Delta T_{JL}$$

ΔT_{JL} is the increase in junction temperature above the lead temperature and may be found from Figure 2 for a train of power pulses ($L = 3/8$ inch) or from Figure 10 for dc power.

$$\Delta T_{JL} = \theta_{JL} P_D$$

For worst-case design, using expected limits of I_Z , limits of P_D and the extremes of T_J (ΔT_J) may be estimated. Changes in voltage, V_Z , can then be found from:

$$\Delta V = \theta_{VZ} \Delta T_J$$

θ_{VZ} , the zener voltage temperature coefficient, is found from Figures 5 and 6.

Under high power-pulse operation, the zener voltage will vary with time and may also be affected significantly by the zener resistance. For best regulation, keep current excursions as low as possible.

Data of Figure 2 should not be used to compute surge capability. Surge limitations are given in Figure 3. They are lower than would be expected by considering only junction temperature, as current crowding effects cause temperatures to be extremely high in small spots resulting in device degradation should the limits of Figure 3 be exceeded.

GENERAL DATA — 1-3 WATT DO-41 SURMETIC 30

TEMPERATURE COEFFICIENT RANGES

(90% of the Units are in the Ranges Indicated)

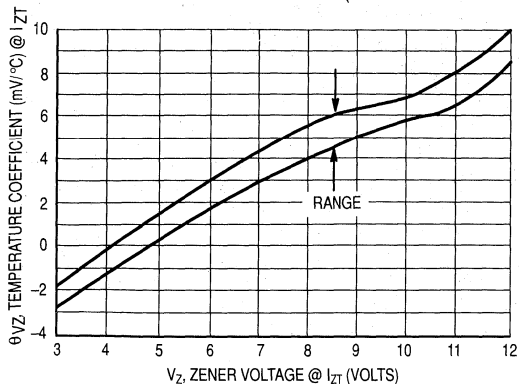

Figure 5. Units To 12 Volts

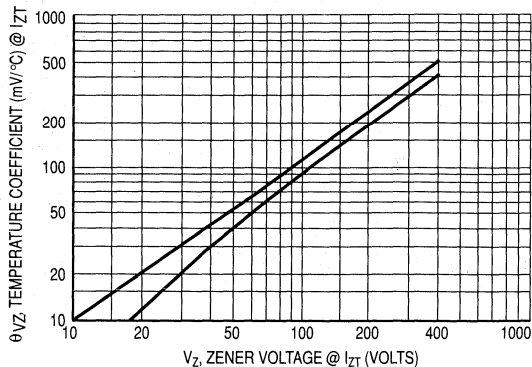

Figure 6. Units 10 To 400 Volts

ZENER VOLTAGE versus ZENER CURRENT

(Figures 7, 8 and 9)

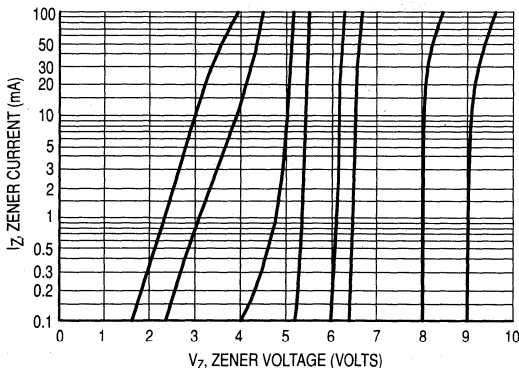

Figure 7. V_Z = 3.3 thru 10 Volts

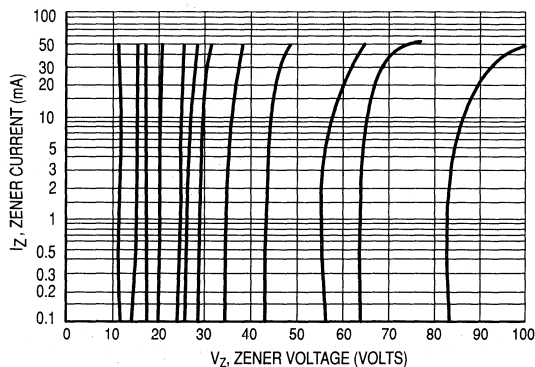

Figure 8. V_Z = 12 thru 82 Volts

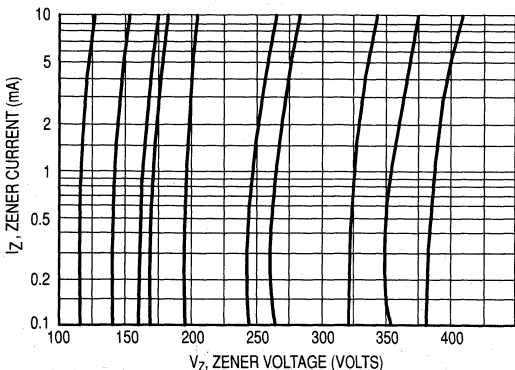

Figure 9. V_Z = 100 thru 400 Volts

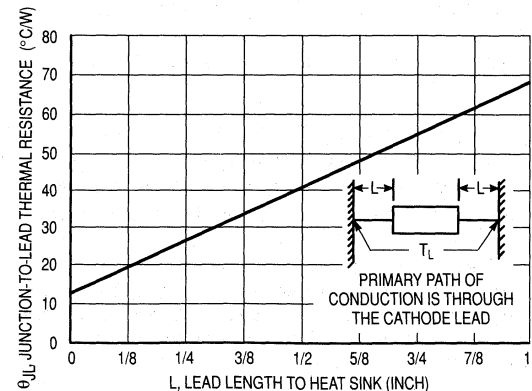

Figure 10. Typical Thermal Resistance

1N5913B thru 1N5956B

*MAXIMUM RATINGS			
Rating	Symbol	Value	Unit
DC Power Dissipation @ $T_L = 75^\circ\text{C}$, Lead Length = 3/8"	P_D	1.5 12	Watts mW/ $^\circ\text{C}$
Derate above 75°C			

*ELECTRICAL CHARACTERISTICS ($T_L = 30^\circ\text{C}$ unless otherwise noted. $V_F = 1.5$ Volts Max @ $I_F = 200$ mAdc for all types.)								
Motorola Type Number (Note 1)	Nominal Zener Voltage V_Z @ I_{ZT} Volts (Note 2 and 3)	Test Current I_{ZT} mA	Max. Zener Impedance (Note 4)			Max. Reverse Leakage Current		Maximum DC Zener Current I_{ZM} mAdc
			Z_{ZT} @ I_{ZT} Ohms	Z_{ZK} Ohms @ I_{ZK} mA	I_R @ V_R μA Volts			
1N5913B	3.3	113.6	10	500	1	100	1	454
1N5914B	3.6	104.2	9	500	1	75	1	416
1N5915B	3.9	96.1	7.5	500	1	25	1	384
1N5916B	4.3	87.2	6	500	1	5	1	348
1N5917B	4.7	79.8	5	500	1	5	1.5	319
\Rightarrow 1N5918B	5.1	73.5	4	350	1	5	2	294
1N5919B	5.6	66.9	2	250	1	5	3	267
\Rightarrow 1N5920B	6.2	60.5	2	200	1	5	4	241
1N5921B	6.8	55.1	2.5	200	1	5	5.2	220
1N5922B	7.5	50	3	400	0.5	5	6	200
1N5923B	8.2	45.7	3.5	400	0.5	5	6.5	182
1N5924B	9.1	41.2	4	500	0.5	5	7	164
1N5925B	10	37.5	4.5	500	0.25	5	8	150
1N5926B	11	34.1	5.5	550	0.25	1	8.4	136
1N5927B	12	31.2	6.5	550	0.25	1	9.1	125
1N5928B	13	28.8	7	550	0.25	1	9.9	115
\Rightarrow 1N5929B	15	25	9	600	0.25	1	11.4	100
1N5930B	16	23.4	10	600	0.25	1	12.2	93
1N5931B	18	20.8	12	650	0.25	1	13.7	83
1N5932B	20	18.7	14	650	0.25	1	15.2	75
1N5933B	22	17	17.5	650	0.25	1	16.7	68
\Rightarrow 1N5934B	24	15.6	19	700	0.25	1	18.2	62
1N5935B	27	13.9	23	700	0.25	1	20.6	55
\Rightarrow 1N5936B	30	12.5	26	750	0.25	1	22.8	50
1N5937B	33	11.4	33	800	0.25	1	25.1	45
1N5938B	36	10.4	38	850	0.25	1	27.4	41
1N5939B	39	9.6	45	900	0.25	1	29.7	38
1N5940B	43	8.7	53	950	0.25	1	32.7	34
\Rightarrow 1N5941B	47	8	67	1000	0.25	1	35.8	31
1N5942B	51	7.3	70	1100	0.25	1	38.8	29
1N5943B	56	6.7	86	1300	0.25	1	42.6	26
1N5944B	62	6	100	1500	0.25	1	47.1	24
1N5945B	68	5.5	120	1700	0.25	1	51.7	22
1N5946B	75	5	140	2000	0.25	1	56	20
1N5947B	82	4.6	160	2500	0.25	1	62.2	18

(continued)

\Rightarrow Preferred part

*Indicates JEDEC Registered Data.

4

4.2

1N5913B thru 1N5956B

***ELECTRICAL CHARACTERISTICS — continued** ($T_L = 30^\circ\text{C}$ unless otherwise noted. $V_F = 1.5$ Volts Max @ $I_F = 200$ mAdc for all types.)

Motorola Type Number (Note 1)	Nominal Zener Voltage $V_Z @ I_{ZT}$ Volts (Note 2 and 3)	Test Current I_{ZT} mA	Max. Zener Impedance (Note 4)			Max. Reverse Leakage Current		Maximum DC Zener Current I_{ZM} mAdc
			$Z_{ZT} @ I_{ZT}$ Ohms	$Z_{ZK} @ I_{ZK}$ Ohms	$I_R @ V_R$ μA Volts			
1N5948B	91	4.1	200	3000	0.25	1	69.2	16
1N5949B	100	3.7	250	3100	0.25	1	76	15
1N5950B	110	3.4	300	4000	0.25	1	83.6	13
1N5951B	120	3.1	380	4500	0.25	1	91.2	12
1N5952B	130	2.9	450	5000	0.25	1	98.8	11
1N5953B	150	2.5	600	6000	0.25	1	114	10
1N5954B	160	2.3	700	6500	0.25	1	121.6	9
1N5955B	180	2.1	900	7000	0.25	1	136.8	8
1N5956B	200	1.9	1200	8000	0.25	1	152	7

*Indicates JEDEC Registered Data.

NOTE 1. TOLERANCE AND VOLTAGE DESIGNATION

Tolerance designation — Device tolerances of $\pm 5\%$ are indicated by a "B" suffix.

NOTE 2. SPECIAL SELECTIONS AVAILABLE INCLUDE:

Nominal zener voltages between those shown and $\pm 1\%$ and $\pm 2\%$ tight voltage tolerances. Consult factory.

NOTE 3. ZENER VOLTAGE (V_Z) MEASUREMENT

Motorola guarantees the zener voltage when measured at 90 seconds while maintaining the lead temperature (T_L) at $30^\circ\text{C} \pm 1^\circ\text{C}$, $3/8"$ from the diode body.

NOTE 4. ZENER IMPEDANCE (Z_Z) DERIVATION

The zener impedance is derived from the 60 cycle ac voltage, which results when an ac current having an rms value equal to 10% of the dc zener current (I_{ZT} or I_{ZK}) is superimposed on I_{ZT} or I_{ZK} .

4

4.2

3EZ3.9D5 thru 3EZ400D5

ELECTRICAL CHARACTERISTICS ($T_A = 25^\circ\text{C}$ unless otherwise noted) $V_F = 1.5\text{ V Max}$, $I_F = 200\text{ mA}$ for all types)									
Motorola Type No. (Note 1)	Nominal Zener Voltage $V_Z @ I_{ZT}$ Volts (Note 2)	Test Current I_{ZT} mA	Max Zener Impedance (Note 3)			Leakage Current		Maximum Zener Current I_{ZM} mA	Surge Current @ $T_A = 25^\circ\text{C}$ $i_T - \text{mA}$ (Note 4)
			$Z_{ZT} @ I_{ZT}$ Ohms	$Z_{ZK} @ I_{ZK}$ Ohms	I_{ZK} mA	$I_R @ V_R$ $\mu\text{A Max}$ Volts			
3EZ3.9D5	3.9	192	4.5	400	1	80	1	630	4.4
3EZ4.3D5	4.3	174	4.5	400	1	30	1	590	4.1
3EZ4.7D5	4.7	160	4	500	1	20	1	550	3.8
3EZ5.1D5	5.1	147	3.5	550	1	5	1	520	3.5
3EZ5.6D5	5.6	134	2.5	600	1	5	2	480	3.3
3EZ6.2D5	6.2	121	1.5	700	1	5	3	435	3.1
3EZ6.8D5	6.8	110	2	700	1	5	4	393	2.9
3EZ7.5D5	7.5	100	2	700	0.5	5	5	360	2.66
3EZ8.2D5	8.2	91	2.3	700	0.5	5	6	330	2.44
3EZ9.1D5	9.1	82	2.5	700	0.5	3	7	297	2.2
3EZ10D5	10	75	3.5	700	0.25	3	7.6	270	2
3EZ11D5	11	68	4	700	0.25	1	8.4	245	1.82
3EZ12D5	12	63	4.5	700	0.25	1	9.1	225	1.66
3EZ13D5	13	58	4.5	700	0.25	0.5	9.9	208	1.54
3EZ14D5	14	53	5	700	0.25	0.5	10.6	193	1.43
3EZ15D5	15	50	5.5	700	0.25	0.5	11.4	180	1.33
3EZ16D5	16	47	5.5	700	0.25	0.5	12.2	169	1.25
3EZ17D5	17	44	6	750	0.25	0.5	13	159	1.18
3EZ18D5	18	42	6	750	0.25	0.5	13.7	150	1.11
3EZ19D5	19	40	7	750	0.25	0.5	14.4	142	1.05
3EZ20D5	20	37	7	750	0.25	0.5	15.2	135	1
3EZ22D5	22	34	8	750	0.25	0.5	16.7	123	0.91
3EZ24D5	24	31	9	750	0.25	0.5	18.2	112	0.83
3EZ27D5	27	28	10	750	0.25	0.5	20.6	100	0.74
3EZ28D5	28	27	12	750	0.25	0.5	21	96	0.71
3EZ30D5	30	25	16	1000	0.25	0.5	22.5	90	0.67
3EZ33D5	33	23	20	1000	0.25	0.5	25.1	82	0.61
3EZ36D5	36	21	22	1000	0.25	0.5	27.4	75	0.56
3EZ39D5	39	19	28	1000	0.25	0.5	29.7	69	0.51
3EZ43D5	43	17	33	1500	0.25	0.5	32.7	63	0.45
3EZ47D5	47	16	38	1500	0.25	0.5	35.6	57	0.42
3EZ51D5	51	15	45	1500	0.25	0.5	38.8	53	0.39
3EZ56D5	56	13	50	2000	0.25	0.5	42.6	48	0.36
3EZ62D5	62	12	55	2000	0.25	0.5	47.1	44	0.32
3EZ68D5	68	11	70	2000	0.25	0.5	51.7	40	0.29
3EZ75D5	75	10	85	2000	0.25	0.5	56	36	0.27
3EZ82D5	82	9.1	95	3000	0.25	0.5	62.2	33	0.24
3EZ91D5	91	8.2	115	3000	0.25	0.5	69.2	30	0.22
3EZ100D5	100	7.5	160	3000	0.25	0.5	76	27	0.2
3EZ110D5	110	6.8	225	4000	0.25	0.5	83.6	25	0.18
3EZ120D5	120	6.3	300	4500	0.25	0.5	91.2	22	0.16
3EZ130D5	130	5.8	375	5000	0.25	0.5	98.8	21	0.15
3EZ140D5	140	5.3	475	5000	0.25	0.5	106.4	19	0.14
3EZ150D5	150	5	550	6000	0.25	0.5	114	18	0.13
3EZ160D5	160	4.7	625	6500	0.25	0.5	121.6	17	0.12
3EZ170D5	170	4.4	650	7000	0.25	0.5	130.4	16	0.12
3EZ180D5	180	4.2	700	7000	0.25	0.5	136.8	15	0.11
3EZ190D5	190	4	800	8000	0.25	0.5	144.8	14	0.1

(continued)

4

4.2

3EZ3.9D5 thru 3EZ400D5

ELECTRICAL CHARACTERISTICS — continued ($T_A = 25^\circ\text{C}$ unless otherwise noted) $V_F = 1.5\text{ V Max}$, $I_F = 200\text{ mA}$ for all types)									
Motorola Type No. (Note 1)	Nominal Zener Voltage $V_Z @ I_{ZT}$ Volts (Note 2)	Test Current I_{ZT} mA	Max Zener Impedance (Note 3)			Leakage Current		Maximum Zener Current I_{ZM} mA	Surge Current i_s — mA (Note 4) @ $T_A = 25^\circ\text{C}$
			$Z_{ZT} @ I_{ZT}$ Ohms	$Z_{ZK} @ I_{ZK}$ Ohms	I_{ZK} mA	$I_R @ V_R$ $\mu\text{A Max}$ Volts			
3EZ200D5	200	3.7	875	8000	0.25	0.5	152	13	0.1
3EZ220D5	220	3.4	1600	9000	0.25	1	167	12	0.09
3EZ240D5	240	3.1	1700	9000	0.25	1	182	11	0.09
3EZ270D5	270	2.8	1800	9000	0.25	1	205	10	0.08
3EZ300D5	300	2.5	1900	9000	0.25	1	228	9	0.07
3EZ330D5	330	2.3	2200	9000	0.25	1	251	8	0.06
3EZ360D5	360	2.1	2700	9000	0.25	1	274	8	0.06
3EZ400D5	400	1.9	3500	9000	0.25	1	304	7	0.06

NOTE 1. TOLERANCES

Suffix 5 indicates 5% tolerance. Any other tolerance will be considered as a special device.

NOTE 2. ZENER VOLTAGE (V_Z) MEASUREMENT

Motorola guarantees the zener voltage when measured at 40 ms \pm 10 ms 3/8" from the diode body, and an ambient temperature of 25°C (+8°C, -2°C)

NOTE 3. ZENER IMPEDANCE (Z_Z) DERIVATION

The zener impedance is derived from the 60 cycle ac voltage, which results when an ac current having an rms value equal to 10% of the dc zener current (I_{ZT} or I_{ZK}) is superimposed on I_{ZT} or I_{ZK} .

NOTE 4. SURGE CURRENT (i_s) NON-REPETITIVE

The rating listed in the electrical characteristics table is maximum peak, non-repetitive, reverse surge current of 1/2 square wave or equivalent sine wave pulse of 1/120 second duration superimposed on the test current, I_{ZT} , per JEDEC standards, however, actual device capability is as described in Figure 3 of General Data sheet for Surmetic 30s.

NOTE 5. SPECIAL SELECTIONS AVAILABLE INCLUDE:

Nominal zener voltages between those shown. Tight voltage tolerances such as $\pm 1\%$ and $\pm 2\%$. Consult factory.

4

4.2

MZD3.9 thru MZD200

ELECTRICAL CHARACTERISTICS (T _A = 25°C unless otherwise noted.) V _F = 1.5 V Max, I _F = 200 mA for all types.								
Type No. (Note 1)	Zener Voltage (Note 2)		Test Current I _{ZT} mA	Zener Impedance at I _{ZT} f = 1000 Hz (Ohm)		Blocking Voltage I _R = 1 μA	Typical T _C %/°C	Surge Current @ T _L = 25°C I _r - mA (Note 3)
	Min	Max		Typ	Max			
MZD3.9	3.7	4.1	100	3.8	7	—	-0.06	1380
MZD4.3	4	4.6	100	3.8	7	—	± 0.055	1260
MZD4.7	4.4	5	100	3.8	7	—	± 0.03	1190
MZD5.1	4.8	5.4	100	2	5	—	± 0.03	1070
MZD5.6	5.2	6	100	1	2	1.5	+0.038	970
MZD6.2	5.8	6.6	100	1	2	1.5	+0.045	890
MZD6.8	6.4	7.2	100	1	2	2	+0.05	810
MZD7.5	7	7.9	100	1	2	2	+0.058	730
MZD8.2	7.7	8.7	100	1	2	3.5	+0.062	660
MZD9.1	8.5	9.6	50	2	4	3.5	+0.068	605
MZD10	9.4	10.6	50	2	4	5	+0.075	550
MZD11	10.4	11.6	50	4	7	5	+0.076	500
MZD12	11.4	12.7	50	4	7	7	+0.077	454
MZD13	12.4	14.1	50	5	10	7	+0.079	414
MZD15	13.8	15.8	50	5	10	10	+0.082	380
MZD16	15.3	17.1	25	6	15	10	+0.083	344
MZD18	16.8	19.1	25	6	15	10	+0.085	304
MZD20	18.8	21.2	25	6	15	10	+0.086	285
MZD22	20.8	23.3	25	6	15	12	+0.087	250
MZD24	22.8	25.6	25	7	15	12	+0.088	225
MZD27	25.1	28.9	25	7	15	14	+0.09	205
MZD30	28	32	25	8	15	14	+0.091	190
MZD33	31	35	25	8	15	17	+0.092	170
MZD36	34	38	10	21	40	17	+0.093	150
MZD39	37	41	10	21	40	20	+0.094	135
MZD43	40	46	10	24	45	20	+0.095	125
MZD47	44	50	10	24	45	24	+0.095	115
MZD51	48	54	10	25	60	24	+0.096	110
MZD56	52	60	10	25	60	28	+0.096	95
MZD62	58	66	10	25	80	28	+0.097	90
MZD68	64	72	10	25	80	34	+0.097	80
MZD75	70	79	10	30	100	34	+0.098	70
MZD82	77	88	10	30	100	41	+0.098	65
MZD91	85	96	5	60	200	41	+0.099	60
MZD100	94	106	5	60	200	50	+0.11	55
MZD110	104	116	5	80	250	50	+0.11	50
MZD120	114	127	5	80	250	60	+0.11	45
MZD130	124	141	5	110	300	60	+0.11	—
MZD150	138	156	5	110	300	75	+0.11	—
MZD160	153	171	5	150	350	75	+0.11	—
MZD180	168	191	5	150	350	90	+0.11	—
MZD200	188	212	5	150	350	90	+0.11	—

NOTE 1. TOLERANCE AND TYPE NUMBER DESIGNATION

The type numbers listed have zener voltage min/max limits as shown.

NOTE 2. ZENER VOLTAGE (V_Z) MEASUREMENT

The zener voltage is measured after the test current (I_{ZT}) has been applied for 40 ± 10 milli-seconds, while maintaining a lead temperature (T_L) of 30°C at a point of 10 mm from the diode body.

NOTE 3. (I_r) NON-REPETITIVE SURGE CURRENT

Maximum peak, non-repetitive reverse surge current of half square wave or equivalent sine wave pulse of 50 ms duration, superimposed on the test current (I_{ZT}).

NOTE 4. SPECIAL SELECTIONS AVAILABLE INCLUDE:

Nominal zener voltages between those shown. Tight voltage tolerances such as ±1% and ±2%. Consult factory.

4

4.2

MZP4728A thru MZP4764A, 1M110ZS5 thru 1M200ZS5

ELECTRICAL CHARACTERISTICS ($T_A = 25^\circ\text{C}$ unless otherwise noted) $V_F = 1.5\text{ V Max}$, $I_F = 200\text{ mA}$ for all types

Motorola Type No. (Note 1)	Nominal Zener Voltage $V_Z @ I_{ZT}$ Volts (Note 2)	Test Current I_{ZT} mA	Max Zener Impedance (Note 3)			Leakage Current		Surge Current @ $T_A = 25^\circ\text{C}$ $I_T - \text{mA}$ (Note 4)
			$Z_{ZT} @ I_{ZT}$ Ohms	$Z_{ZK} @ I_{ZK}$ Ohms	I_{ZK} mA	$I_R @ V_R$ $\mu\text{A Max}$ Volts		
MZP4728A	3.3	76	10	400	1	100	1	1380
MZP4729A	3.6	69	10	400	1	100	1	1260
MZP4730A	3.9	64	9	400	1	50	1	1190
MZP4731A	4.3	58	9	400	1	10	1	1070
MZP4732A	4.7	53	8	500	1	10	1	970
⇒ MZP4733A	5.1	49	7	550	1	10	1	890
MZP4734A	5.6	45	5	600	1	10	2	810
⇒ MZP4735A	6.2	41	2	700	1	10	3	730
MZP4736A	6.8	37	3.5	700	1	10	4	660
MZP4737A	7.5	34	4	700	0.5	10	5	605
MZP4738A	8.2	31	4.5	700	0.5	10	6	550
MZP4739A	9.1	28	5	700	0.5	10	7	500
MZP4740A	10	25	7	700	0.25	10	7.6	454
MZP4741A	11	23	8	700	0.25	5	8.4	414
MZP4742A	12	21	9	700	0.25	5	9.1	380
MZP4743A	13	19	10	700	0.25	5	9.9	344
⇒ MZP4744A	15	17	14	700	0.25	5	11.4	304
⇒ MZP4745A	16	15.5	16	700	0.25	5	12.2	285
⇒ MZP4746A	18	14	20	750	0.25	5	13.7	250
MZP4747A	20	12.5	22	750	0.25	5	15.2	225
MZP4748A	22	11.5	23	750	0.25	5	16.7	205
⇒ MZP4749A	24	10.5	25	750	0.25	5	18.2	190
MZP4750A	27	9.5	35	750	0.25	5	20.6	170
⇒ MZP4751A	30	8.5	40	1000	0.25	5	22.8	150
MZP4752A	33	7.5	45	1000	0.25	5	25.1	135
MZP4753A	36	7	50	1000	0.25	5	27.4	125
MZP4754A	39	6.5	60	1000	0.25	5	29.7	115
MZP4755A	43	6	70	1500	0.25	5	32.7	110
MZP4756A	47	5.5	80	1500	0.25	5	35.8	95
MZP4757A	51	5	95	1500	0.25	5	38.8	90
MZP4758A	56	4.5	110	2000	0.25	5	42.6	80
MZP4759A	62	4	125	2000	0.25	5	47.1	70
MZP4760A	68	3.7	150	2000	0.25	5	51.7	65
MZP4761A	75	3.3	175	2000	0.25	5	56	60
MZP4762A	82	3	200	3000	0.25	5	62.2	55
MZP4763A	91	2.8	250	3000	0.25	5	69.2	50
MZP4764A	100	2.5	350	3000	0.25	5	76	45
1M110ZS5	110	2.3	450	4000	0.25	5	83.6	—
1M120ZS5	120	2	550	4500	0.25	5	91.2	—
1M130ZS5	130	1.9	700	5000	0.25	5	98.8	—
1M150ZS5	150	1.7	1000	6000	0.25	5	114	—
1M160ZS5	160	1.6	1100	6500	0.25	5	121.6	—
1M180ZS5	180	1.4	1200	7000	0.25	5	136.8	—
1M200ZS5	200	1.2	1500	8000	0.25	5	152	—

4

4.2

⇒ Preferred part

NOTE 1. TOLERANCE AND TYPE NUMBER DESIGNATION

The type numbers listed have a standard tolerance on the nominal zener voltage of $\pm 5\%$. The tolerance on the 1M type numbers is indicated by the digits following ZS in the part number. "5" indicates a $\pm 5\%$ V_Z tolerance.

NOTE 2. ZENER VOLTAGE (V_Z) MEASUREMENT

Motorola guarantees the zener voltage when measured at 90 seconds while maintaining the lead temperature (T_L) at $30^\circ\text{C} \pm 1^\circ\text{C}$, $3/8"$ from the diode body.

NOTE 3. ZENER IMPEDANCE (Z_Z) DERIVATION

The zener impedance is derived from the 60 cycle ac voltage, which results when an ac

current having an rms value equal to 10% of the dc zener current (I_{ZT} or I_{ZK}) is superimposed on I_{ZT} or I_{ZK} .

NOTE 4. SURGE CURRENT (I_T) NON-REPETITIVE

The rating listed in the electrical characteristics table is maximum peak, non-repetitive, reverse surge current of 1/2 square wave or equivalent sine wave pulse of 1/120 second duration superimposed on the test current, I_{ZT} , however, actual device capability is as described in Figure 3 of General Data — Surmetic 30.

NOTE 5. SPECIAL SELECTIONS AVAILABLE INCLUDE:

Nominal zener voltages between those shown. Tight voltage tolerances such as $\pm 1\%$ and $\pm 2\%$. Consult factory.

SECTION 4.2.4 DATA SHEETS

ZENER VOLTAGE REGULATOR DIODES — continued

Section 4.2.4.1 Axial Leaded — continued

SECTION 4.2.4.1.4 5 WATT SURMETIC 40

DATA SHEETS

Devices	Page No.
1N5333B thru 1N5388B	4-2-58

MULTIPLE PACKAGE QUANTITY (MPQ) REQUIREMENTS

Package Option	Type No. Suffix	MPQ (Units)
Tape and Reel	RL	4K
Tape and Ammo	TA	2K

4

4.2

5 Watt Surmetic 40 Silicon Zener Diodes

... a complete series of 5 Watt Zener Diodes with tight limits and better operating characteristics that reflect the superior capabilities of silicon-oxide-passivated junctions. All this in an axial-lead, transfer-molded plastic package offering protection in all common environmental conditions.

Specification Features:

- Up to 180 Watt Surge Rating @ 8.3 ms
- Maximum Limits Guaranteed on Seven Electrical Parameters

Mechanical Characteristics:

CASE: Void-free, transfer-molded, thermosetting plastic

FINISH: All external surfaces are corrosion resistant and leads are readily solderable

POLARITY: Cathode indicated by color band. When operated in zener mode, cathode will be positive with respect to anode

MOUNTING POSITION: Any

WEIGHT: 0.7 gram (approx)

**1N5333B
 thru
 1N5388B**

**5 WATT
 ZENER REGULATOR
 DIODES
 3.3-200 VOLTS**

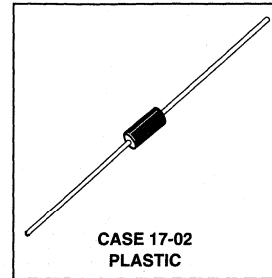

4

MAXIMUM RATINGS

Rating	Symbol	Value	Unit
DC Power Dissipation @ $T_L = 75^\circ\text{C}$ Lead Length = 3/8"	P_D	5	Watts
Derate above 75°C		40	mW/ $^\circ\text{C}$
Operating and Storage Junction Temperature Range	T_J, T_{stg}	- 65 to +200	$^\circ\text{C}$

4.2

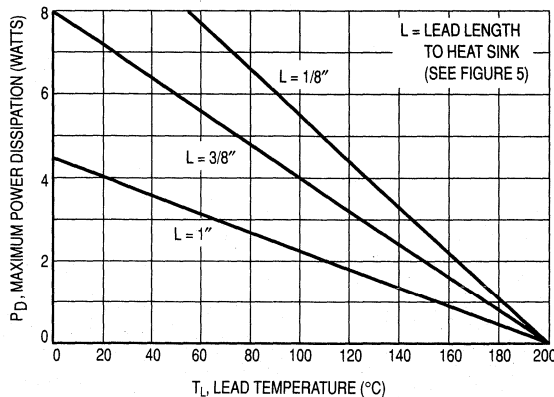

Figure 1. Power Temperature Derating Curve

1N5333B thru 1N5388B

ELECTRICAL CHARACTERISTICS (T _A = 25°C unless otherwise noted, V _F = 1.2 Max @ I _F = 1 A for all types)									
JEDEC Type No. (Note 1)	Nominal Zener Voltage V _Z @ I _{ZT} (Note 2) Volts	Test Current I _{ZT} mA	Max Zener Impedance		Max Reverse Leakage Current		Max Surge Current I _S , Amps (Note 3)	Max Voltage Regulation ΔV _Z , Volt (Note 4)	Maximum Regulator Current I _{ZM} mA (Note 5)
			Z _{ZT} @ I _{ZT} Ohms (Note 2)	Z _{ZK} @ I _{ZK} = 1 mA Ohms (Note 2)	I _R μA	@ V _R Volts			
⇒ 1N5333B	3.3	380	3	400	300	1	20	0.85	1440
1N5334B	3.6	350	2.5	500	150	1	18.7	0.8	1320
1N5335B	3.9	320	2	500	50	1	17.6	0.54	1220
1N5336B	4.3	290	2	500	10	1	16.4	0.49	1100
1N5337B	4.7	260	2	450	5	1	15.3	0.44	1010
⇒ 1N5338B	5.1	240	1.5	400	1	1	14.4	0.39	930
⇒ 1N5339B	5.6	220	1	400	1	2	13.4	0.25	865
1N5340B	6	200	1	300	1	3	12.7	0.19	790
1N5341B	6.2	200	1	200	1	3	12.4	0.1	765
⇒ 1N5342B	6.8	175	1	200	10	5.2	11.5	0.15	700
⇒ 1N5343B	7.5	175	1.5	200	10	5.7	10.7	0.15	630
⇒ 1N5344B	8.2	150	1.5	200	10	6.2	10	0.2	580
1N5345B	8.7	150	2	200	10	6.6	9.5	0.2	545
1N5346B	9.1	150	2	150	7.5	6.9	9.2	0.22	520
⇒ 1N5347B	10	125	2	125	5	7.6	8.6	0.22	475
1N5348B	11	125	2.5	125	5	8.4	8	0.25	430
⇒ 1N5349B	12	100	2.5	125	2	9.1	7.5	0.25	395
⇒ 1N5350B	13	100	2.5	100	1	9.9	7	0.25	365
1N5351B	14	100	2.5	75	1	10.6	6.7	0.25	340
⇒ 1N5352B	15	75	2.5	75	1	11.5	6.3	0.25	315
⇒ 1N5353B	16	75	2.5	75	1	12.2	6	0.3	295
1N5354B	17	70	2.5	75	0.5	12.9	5.8	0.35	280
⇒ 1N5355B	18	65	2.5	75	0.5	13.7	5.5	0.4	265
1N5356B	19	65	3	75	0.5	14.4	5.3	0.4	250
⇒ 1N5357B	20	65	3	75	0.5	15.2	5.1	0.4	237
1N5358B	22	50	3.5	75	0.5	16.7	4.7	0.45	216
⇒ 1N5359B	24	50	3.5	100	0.5	18.2	4.4	0.55	198
⇒ 1N5360B	25	50	4	110	0.5	19	4.3	0.55	190
⇒ 1N5361B	27	50	5	120	0.5	20.6	4.1	0.6	176
1N5362B	28	50	6	130	0.5	21.2	3.9	0.6	170
⇒ 1N5363B	30	40	8	140	0.5	22.8	3.7	0.6	158
⇒ 1N5364B	33	40	10	150	0.5	25.1	3.5	0.6	144
⇒ 1N5365B	36	30	11	160	0.5	27.4	3.3	0.65	132
⇒ 1N5366B	39	30	14	170	0.5	29.7	3.1	0.65	122
1N5367B	43	30	20	190	0.5	32.7	2.8	0.7	110
⇒ 1N5368B	47	25	25	210	0.5	35.8	2.7	0.8	100
1N5369B	51	25	27	230	0.5	38.8	2.5	0.9	93
1N5370B	56	20	35	280	0.5	42.6	2.3	1	86
1N5371B	60	20	40	350	0.5	42.5	2.2	1.2	79
⇒ 1N5372B	62	20	42	400	0.5	47.1	2.1	1.35	76
1N5373B	68	20	44	500	0.5	51.7	2	1.5	70
1N5374B	75	20	45	620	0.5	56	1.9	1.6	63
1N5375B	82	15	65	720	0.5	62.2	1.8	1.8	58
1N5376B	87	15	75	760	0.5	66	1.7	2	54.5
1N5377B	91	15	75	760	0.5	69.2	1.6	2.2	52.5
1N5378B	100	12	90	800	0.5	76	1.5	2.5	47.5
1N5379B	110	12	125	1000	0.5	83.6	1.4	2.5	43
1N5380B	120	10	170	1150	0.5	91.2	1.3	2.5	39.5
1N5381B	130	10	190	1250	0.5	98.8	1.2	2.5	36.6
1N5382B	140	8	230	1500	0.5	106	1.2	2.5	34

(continued)

⇒ Preferred part

4

4.2

1N5333B thru 1N5388B

ELECTRICAL CHARACTERISTICS — continued ($T_A = 25^\circ\text{C}$ unless otherwise noted, $V_F = 1.2$ Max @ $I_F = 1$ A for all types)									
JEDEC Type No. (Note 1)	Nominal Zener Voltage V_Z @ I_{ZT} Volts (Note 2)	Test Current I_{ZT} mA	Max Zener Impedance		Max Reverse Leakage Current		Max Surge Current I_s , Amps (Note 3)	Max Voltage Regulation ΔV_Z , Volt (Note 4)	Maximum Regulator Current I_{ZM} mA (Note 5)
			Z_{ZT} @ I_{ZT} Ohms (Note 2)	Z_{ZK} @ $I_{ZK} = 1$ mA Ohms (Note 2)	I_R @ V_R μA	Volts			
⇒ 1N5383B	150	8	330	1500	0.5	114	1.1	3	31.6
1N5384B	160	8	350	1650	0.5	122	1.1	3	29.4
1N5385B	170	8	380	1750	0.5	129	1	3	28
1N5386B	180	5	430	1750	0.5	137	1	4	26.4
1N5387B	190	5	450	1850	0.5	144	0.9	5	25
1N5388B	200	5	480	1850	0.5	152	0.9	5	23.6

⇒ Preferred part

NOTE 1. TOLERANCE AND TYPE NUMBER DESIGNATION

The JEDEC type numbers shown indicate a tolerance of $\pm 5\%$.

NOTE 2. ZENER VOLTAGE (V_Z) AND IMPEDANCE (Z_{ZT} & Z_{ZK})

Test conditions for zener voltage and impedance are as follows: I_Z is applied 40 ± 10 ms prior to reading. Mounting contacts are located $3/8''$ to $1/2''$ from the inside edge of mounting clips to the body of the diode. ($T_A = 25^\circ\text{C} +8, -2^\circ\text{C}$).

NOTE 3. SURGE CURRENT (I_s)

Surge current is specified as the maximum allowable peak, non-recurrent square-wave current with a pulse width, PW, of 8.3 ms. The data given in Figure 6 may be used to find the maximum surge current for a square wave of any pulse width between 1 ms and 1000 ms by plotting the applicable points on logarithmic paper. Examples of this, using the 3.3 V and 200 V zeners, are shown in Figure 7. Mounting contact located as specified in Note 3. ($T_A = 25^\circ\text{C} +8, -2^\circ\text{C}$).

NOTE 4. VOLTAGE REGULATION (ΔV_Z)

Test conditions for voltage regulation are as follows: V_Z measurements are made at 10% and then at 50% of the I_Z max value listed in the electrical characteristics table. The test current time duration for each V_Z measurement is 40 ± 10 ms. ($T_A = 25^\circ\text{C} +8, -2^\circ\text{C}$). Mounting contact located as specified in Note 2.

NOTE 5. MAXIMUM REGULATOR CURRENT (I_{ZM})

The maximum current shown is based on the maximum voltage of a 5% type unit, therefore, it applies only to the B-suffix device. The actual I_{ZM} for any device may not exceed the value of 5 watts divided by the actual V_Z of the device. $T_L = 75^\circ\text{C}$ at $3/8''$ maximum from the device body.

NOTE 6. SPECIALS AVAILABLE INCLUDE:

Nominal zener voltages between the voltages shown and tighter voltage tolerance such as $\pm 1\%$ and $\pm 2\%$. Consult factory.

4

TEMPERATURE COEFFICIENTS

4.2

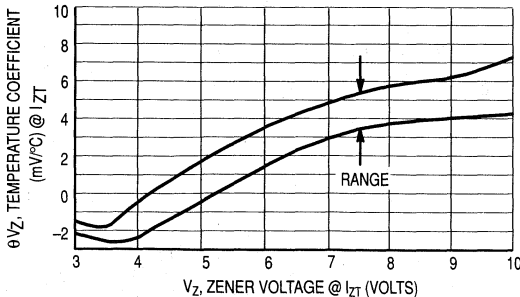

Figure 2. Temperature Coefficient-Range for Units 3 to 10 Volts

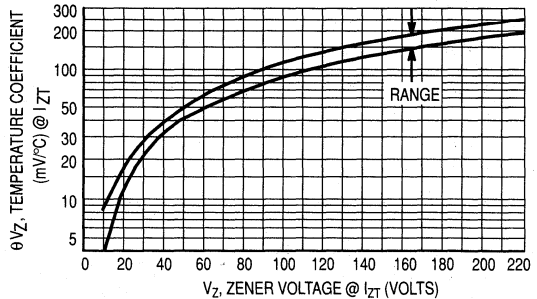

Figure 3. Temperature Coefficient-Range for Units 10 to 220 Volts

1N5333B thru 1N5388B

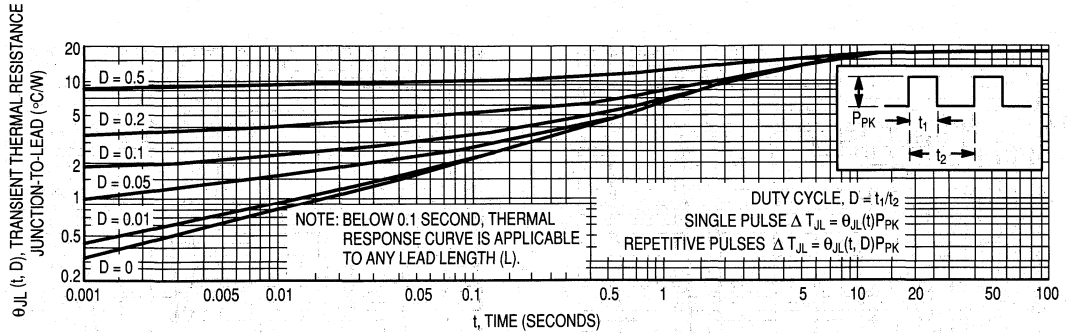

Figure 4. Typical Thermal Response
L, Lead Length = 3/8 Inch

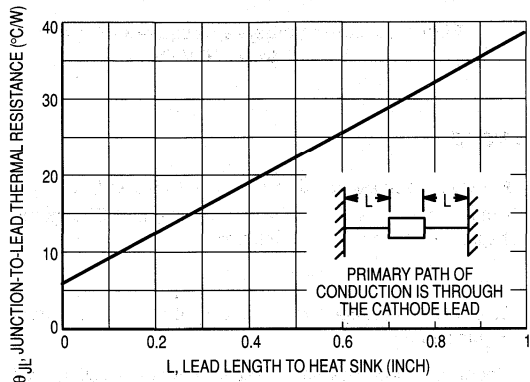

Figure 5. Typical Thermal Resistance

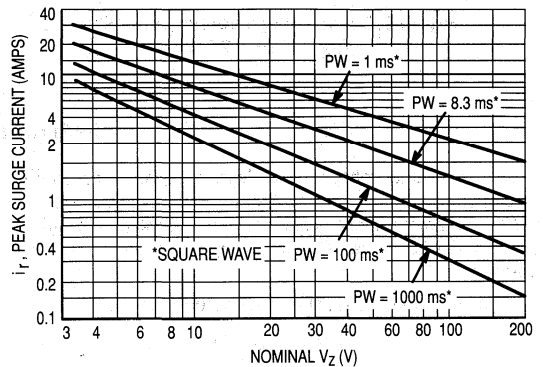

Figure 6. Maximum Non-Repetitive Surge Current versus Nominal Zener Voltage
(See Note 3)

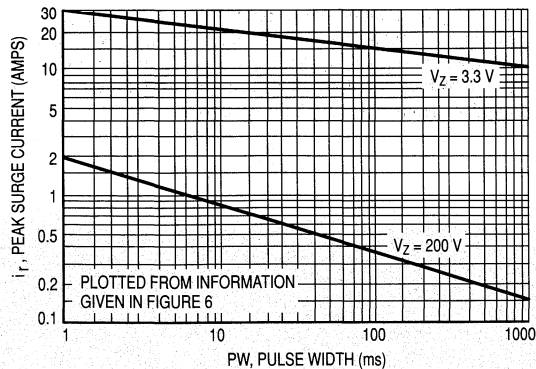

Figure 7. Peak Surge Current versus Pulse Width
(See Note 3)

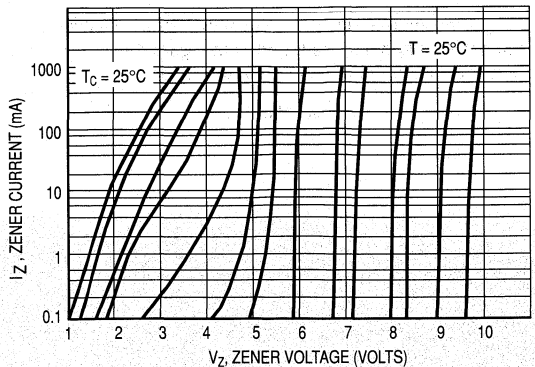

Figure 8. Zener Voltage versus Zener Current
 $V_Z = 3.3$ thru 10 Volts

4

4.2

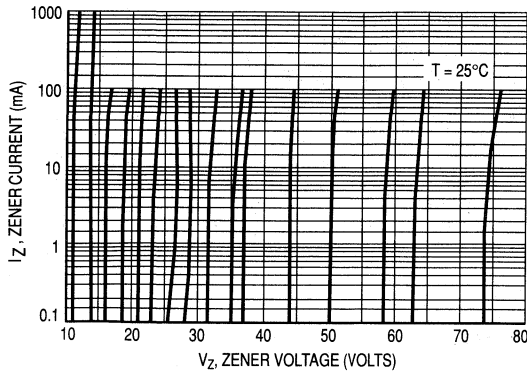

Figure 9. Zener Voltage versus Zener Current
 $V_Z = 11$ thru 75 Volts

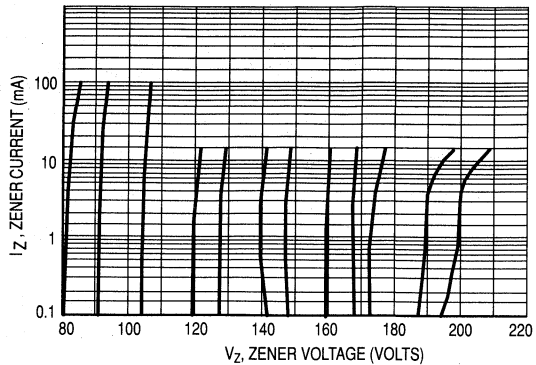

Figure 10. Zener Voltage versus Zener Current
 $V_Z = 82$ thru 200 Volts

APPLICATION NOTE

Since the actual voltage available from a given zener diode is temperature dependent, it is necessary to determine junction temperature under any set of operating conditions in order to calculate its value. The following procedure is recommended:

Lead Temperature, T_L , should be determined from:

$$T_L = \theta_{LA} P_D + T_A$$

θ_{LA} is the lead-to-ambient thermal resistance and P_D is the power dissipation.

Junction Temperature, T_J , may be found from:

$$T_J = T_L + \Delta T_{JL}$$

ΔT_{JL} is the increase in junction temperature above the lead temperature and may be found from Figure 4 for a train of power pulses or from Figure 5 for dc power.

$$\Delta T_{JL} = \theta_{JL} P_D$$

For worst-case design, using expected limits of I_Z , limits of P_D and the extremes of T_J (ΔT_J) may be estimated. Changes in voltage, V_Z , can then be found from:

$$\Delta V = \theta_{VZ} \Delta T_J$$

θ_{VZ} , the zener voltage temperature coefficient, is found from Figures 2 and 3.

Under high power-pulse operation, the zener voltage will vary with time and may also be affected significantly by the zener resistance. For best regulation, keep current excursions as low as possible.

Data of Figure 4 should not be used to compute surge capability. Surge limitations are given in Figure 6. They are lower than would be expected by considering only junction temperature, as current crowding effects cause temperatures to be extremely high in small spots resulting in device degradation should the limits of Figure 6 be exceeded.

4

4.2

SECTION 4.2.4 DATA SHEETS
ZENER VOLTAGE REGULATOR DIODES — continued

Section 4.2.4.2 Surface Mounted

SECTION 4.2.4.2.1 225 mW SOT-23

DATA SHEETS

Devices	Page No.
General Data — 225 mW SOT-23	4-2-64
BZX84C2V4L thru BZX84C75L	4-2-65
MMBZ5221BL thru MMBZ5270BL	4-2-66

MULTIPLE PACKAGE QUANTITY (MPQ)
REQUIREMENTS

Package Option	Type No. Suffix	MPQ (Units)
Tape and Reel	T1, T2(1)	3K
Tape and Reel	T3, T4(1)	10K
Bulk	(None)	1K

NOTE 1. The numbers on the suffixes indicate the following:
1. 7" Reel. Cathode lead toward sprocket hole.
2. 7" Reel. Cathode lead away from sprocket hole.
3. 13" Reel. Cathode lead toward sprocket hole.
4. 13" Reel. Cathode lead away from sprocket hole.

225 mW SOT-23

Zener Voltage Regulator Diodes

GENERAL DATA APPLICABLE TO ALL SERIES IN THIS GROUP

**Zener Voltage
Regulator Diodes**

**GENERAL
DATA**

**225 mW
SOT-23**

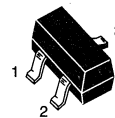
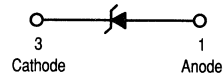

**CASE 318-07, STYLE 8
SOT-23 (TO-236AB)
PLASTIC**

THERMAL CHARACTERISTICS

Characteristic	Symbol	Max	Unit
Total Device Dissipation FR-5 Board,* T _A = 25°C	P _D	225	mW
Derate above 25°C		1.8	mW/°C
Thermal Resistance Junction to Ambient	R _{θJA}	556	°C/W
Total Device Dissipation Alumina Substrate,** T _A = 25°C	P _D	300	mW
Derate above 25°C		2.4	mW/°C
Thermal Resistance Junction to Ambient	R _{θJA}	417	°C/W
Junction and Storage Temperature	T _J , T _{stg}	150	°C

*FR-5 = 1.0 x 0.75 x 0.62 in.

**Alumina = 0.4 x 0.3 x 0.024 in. 99.5% alumina.

4

4.2

BZX84C2V4L thru BZX84C75L

ELECTRICAL CHARACTERISTICS (Pinout: 1-Anode, 2-NC, 3-Cathode) ($V_F = 0.9$ V Max @ $I_F = 10$ mA for all types)																
Type Number	Marking	Zener Voltage V_{Z1} (Volts) @ $I_{ZT1} = 5$ mA (Note 1)			Max Zener Impedance Z_{ZT1} (Ohms) @ $I_{ZT1} = 5$ mA	Max Reverse Leakage Current		Zener Voltage V_{Z2} (Volts) @ $I_{ZT2} = 1$ mA (Note 1)		Max Zener Impedance Z_{ZT2} (Ohms) @ $I_{ZT2} = 1$ mA	Zener Voltage V_{Z3} (Volts) @ $I_{ZT3} = 20$ mA (Note 1)		Max Zener Impedance Z_{ZT3} (Ohms) @ $I_{ZT3} = 20$ mA	d_{VZ}/dt (mV/k) @ $I_{ZT1} = 5$ mA		C pF Max @ $V_R = 0$ $f = 1$ MHz
		Nom	Min	Max		I_R μ A	V_R Volts	Min	Max		Min	Max		Min	Max	
BZX84C2V4L	Z11	2.4	2.2	2.6	100	50	1	1.7	2.1	600	2.6	3.2	50	-3.5	0	450
BZX84C2V7L	Z12	2.7	2.5	2.9	100	20	1	1.9	2.4	600	3	3.6	50	-3.5	0	450
BZX84C3V0L	Z13	3	2.8	3.2	95	10	1	2.1	2.7	600	3.3	3.9	50	-3.5	0	450
BZX84C3V3L	Z14	3.3	3.1	3.5	95	5	1	2.3	2.9	600	3.6	4.2	40	-3.5	0	450
BZX84C3V6L	Z15	3.6	3.4	3.8	90	5	1	2.7	3.3	600	3.9	4.5	40	-3.5	0	450
BZX84C3V9L	Z16	3.9	3.7	4.1	90	3	1	2.9	3.5	600	4.1	4.7	30	-3.5	-2.5	450
BZX84C4V3L	W9	4.3	4	4.6	90	3	1	3.3	4	600	4.4	5.1	30	-3.5	0	450
BZX84C4V7L	Z1	4.7	4.4	5	80	3	2	3.7	4.7	500	4.5	5.4	15	-3.5	0.2	260
BZX84C5V1L	Z2	5.1	4.8	5.4	60	2	2	4.2	5.3	480	5	5.9	15	-2.7	1.2	225
BZX84C5V6L	Z3	5.6	5.2	6	40	1	2	4.8	6	400	5.2	6.3	10	-2.0	2.5	200
BZX84C6V2L	Z4	6.2	5.8	6.6	10	3	4	5.6	6.6	150	5.8	6.8	6	0.4	3.7	185
BZX84C6V8L	Z5	6.8	6.4	7.2	15	2	4	6.3	7.2	80	6.4	7.4	6	1.2	4.5	155
BZX84C7V5L	Z6	7.5	7	7.9	15	1	5	6.9	7.9	80	7	8	6	2.5	5.3	140
BZX84C8V2L	Z7	8.2	7.7	8.7	15	0.7	5	7.6	8.7	80	7.7	8.8	6	3.2	6.2	135
BZX84C9V1L	Z8	9.1	8.5	9.6	15	0.5	6	8.4	9.6	100	8.5	9.7	8	3.8	7.0	130
BZX84C10L	Z9	10	9.4	10.6	20	0.2	7	9.3	10.6	150	9.4	10.7	10	4.5	8.0	130
BZX84C11L	Y1	11	10.4	11.6	20	0.1	8	10.2	11.6	150	10.4	11.8	10	5.4	9.0	130
BZX84C12L	Y2	12	11.4	12.7	25	0.1	8	11.2	12.7	150	11.4	12.9	10	6.0	10.0	130
BZX84C13L	Y3	13	12.4	14.1	30	0.1	8	12.3	14	170	12.5	14.2	15	7.0	11.0	120
BZX84C15L	Y4	15	13.8	15.6	30	0.05	10.5	13.7	15.5	200	13.9	15.7	20	9.2	13.0	110
BZX84C16L	Y5	16	15.3	17.1	40	0.05	11.2	15.2	17	200	15.4	17.2	20	10.4	14.0	105
BZX84C18L	Y6	18	16.8	19.1	45	0.05	12.6	16.7	19	225	16.9	19.2	20	12.4	16.0	100
BZX84C20L	Y7	20	18.8	21.2	55	0.05	14	18.7	21.1	225	18.9	21.4	20	14.4	18.0	85
BZX84C22L	Y8	22	20.8	23.3	55	0.05	15.4	20.7	23.2	250	20.9	23.4	25	16.4	20.0	85
BZX84C24L	Y9	24	22.8	25.6	70	0.05	16.8	22.7	25.5	250	22.9	25.7	25	18.4	22.0	80
		V_{Z1} Below @ $I_{ZT1} = 2$ mA			Z_{ZT1} Below @ $I_{ZT1} = 2$ mA			V_{Z2} Below @ $I_{ZT2} = 0.1$ mA	Z_{ZT2} Below @ $I_{ZT2} = 0.5$ mA (Note 2)		V_{Z3} Below @ $I_{ZT3} = 10$ mA	Z_{ZT3} Below @ $I_{ZT3} = 10$ mA		d_{VZ}/dt (mV/k) Below @ $I_{ZT1} = 2$ mA		
BZX84C27L	Y10	27	25.1	28.9	80	0.05	18.9	25	28.9	300	25.2	29.3	45	21.4	25.3	70
BZX84C30L	Y11	30	28	32	80	0.05	21	27.8	32	300	28.1	32.4	50	24.4	29.4	70
BZX84C33L	Y12	33	31	35	80	0.05	23.1	30.8	35	325	31.1	35.4	55	27.4	33.4	70
BZX84C36L	Y13	36	34	38	90	0.05	25.2	33.8	38	350	34.1	38.4	60	30.4	37.4	70
BZX84C39L	Y14	39	37	41	130	0.05	27.3	36.7	41	350	37.1	41.5	70	33.4	41.2	45
BZX84C43L	Y15	43	40	46	150	0.05	30.1	39.7	46	375	40.1	46.5	80	37.6	46.6	40
BZX84C47L	Y16	47	44	50	170	0.05	32.9	43.7	50	375	44.1	50.5	90	42.0	51.8	40
BZX84C51L	Y17	51	48	54	180	0.05	35.7	47.6	54	400	48.1	54.6	100	46.6	57.2	40
BZX84C56L	Y18	56	52	60	200	0.05	39.2	51.5	60	425	52.1	60.8	110	52.2	63.8	40
BZX84C62L	Y19	62	58	66	215	0.05	43.4	57.4	66	450	58.2	67	120	58.8	71.6	35
BZX84C68L	Y20	68	64	72	240	0.05	47.6	63.4	72	475	64.2	73.2	130	65.6	79.8	35
BZX84C75L	Y21	75	70	79	255	0.05	52.5	69.4	79	500	70.3	80.2	140	73.4	88.6	35

⇒ Preferred part

NOTES: 1. Zener voltage is measured with a pulse test current (I_Z) applied at an ambient temperature of 25°C.

2. The zener impedance, Z_{ZTn} , for the 27 through 75 volt types is tested at 0.5 mA rather than the test current of 0.1 mA used for V_{Z2} .

4

4.2

MMBZ5221BL thru MMBZ5270BL

ELECTRICAL CHARACTERISTICS (Pinout: 1-Anode, 2-NC, 3-Cathode) ($V_F = 0.9\text{ V Max @ } I_F = 10\text{ mA}$ for all types.)							
Device	Marking	Test Current I_Z mA	Zener Voltage $V_Z (\pm 5\%)$ Nominal (Note 1)	Z_{ZK} $I_Z = 0.25\text{ mA}$ $\Omega\text{ Max}$	Z_{ZT} $I_Z = I_Z$ @ 10% Mod $\Omega\text{ Max}$	Max I_R μA	@ V_R V
MMBZ5221BL	18A	20	2.4	1200	30	100	1
MMBZ5222BL	18B	20	2.5	1250	30	100	1
MMBZ5223BL	18C	20	2.7	1300	30	75	1
MMBZ5224BL	18D	20	2.8	1400	30	75	1
MMBZ5225BL	18E	20	3	1600	29	50	1
⇒ MMBZ5226BL	8A	20	3.3	1600	28	25	1
MMBZ5227BL	8B	20	3.6	1700	24	15	1
MMBZ5228BL	8C	20	3.9	1900	23	10	1
⇒ MMBZ5229BL	8D	20	4.3	2000	22	5	1
⇒ MMBZ5230BL	8E	20	4.7	1900	19	5	2
⇒ MMBZ5231BL	8F	20	5.1	1600	17	5	2
⇒ MMBZ5232BL	8G	20	5.6	1600	11	5	3
MMBZ5233BL	8H	20	6	1600	7	5	3.5
⇒ MMBZ5234BL	8J	20	6.2	1000	7	5	4
⇒ MMBZ5235BL	8K	20	6.8	750	5	3	5
⇒ MMBZ5236BL	8L	20	7.5	500	6	3	6
⇒ MMBZ5237BL	8M	20	8.2	500	8	3	6.5
MMBZ5238BL	8N	20	8.7	600	8	3	6.5
⇒ MMBZ5239BL	8P	20	9.1	600	10	3	7
⇒ MMBZ5240BL	8Q	20	10	600	17	3	8
MMBZ5241BL	8R	20	11	600	22	2	8.4
⇒ MMBZ5242BL	8S	20	12	600	30	1	9.1
MMBZ5243BL	8T	9.5	13	600	13	0.5	9.9
MMBZ5244BL	8U	9	14	600	15	0.1	10
⇒ MMBZ5245BL	8V	8.5	15	600	16	0.1	11
MMBZ5246BL	8W	7.8	16	600	17	0.1	12
MMBZ5247BL	8X	7.4	17	600	19	0.1	13
MMBZ5248BL	8Y	7	18	600	21	0.1	14
MMBZ5249BL	8Z	6.6	19	600	23	0.1	14
MMBZ5250BL	81A	6.2	20	600	25	0.1	15
MMBZ5251BL	81B	5.6	22	600	29	0.1	17
MMBZ5252BL	81C	5.2	24	600	33	0.1	18
MMBZ5253BL	81D	5	25	600	35	0.1	19
⇒ MMBZ5254BL	81E	4.6	27	600	41	0.1	21
⇒ MMBZ5255BL	81F	4.5	28	600	44	0.1	21
MMBZ5256BL	81G	4.2	30	600	49	0.1	23
MMBZ5257BL	81H	3.8	33	700	58	0.1	25
MMBZ5258BL	81J	3.4	36	700	70	0.1	27
MMBZ5259BL	81K	3.2	39	800	80	0.1	30
MMBZ5260BL	18F	3	43	900	93	0.1	33
MMBZ5261BL	18G	2.7	47	1000	105	0.1	36
MMBZ5262BL	81L	2.5	51	1100	125	0.1	39
MMBZ5263BL	81M	2.2	56	1300	150	0.1	43
MMBZ5264BL	81N	2.1	60	1400	170	0.1	46
MMBZ5265BL	18H	2	62	1400	185	0.1	47
MMBZ5266BL	81P	1.8	68	1600	230	0.1	52
MMBZ5267BL	18J	1.7	75	1700	270	0.1	56
MMBZ5268BL	18K	1.5	82	2000	330	0.1	62
MMBZ5269BL	18L	1.4	87	2200	370	0.1	68
MMBZ5270BL	81Q	1.4	91	2300	400	0.1	69

⇒ Preferred part

NOTE 1. Zener voltage is measured with a pulse test current (I_Z) applied at an ambient temperature of 25°C.

SECTION 4.2.4 DATA SHEETS
 ZENER VOLTAGE REGULATOR DIODES — continued

Section 4.2.4.2 Surface Mounted — continued

SECTION 4.2.4.2.2 500 mW LEADLESS (DO-34 BODY SIZE)

4

DATA SHEETS

Devices	Page No.
General Data — 500 mW Leadless	4-2-68
BZV55C2V4 thru BZV55C56	4-2-73
MLL4678 thru MLL4717	4-2-74
MLL5221B thru MLL5263B	4-2-75

MULTIPLE PACKAGE QUANTITY (MPQ)
 REQUIREMENTS

Package Option	Type No. Suffix	MPQ (Units)
Tape and Reel	T1, T2(1)	2K
Tape and Reel	T3, T4(1)	5K

NOTE 1. The numbers on the suffixes indicate the following:

1. 7" Reel. Cathode lead toward sprocket hole.
2. 7" Reel. Cathode lead away from sprocket hole.
3. 13" Reel. Cathode lead toward sprocket hole.
4. 13" Reel. Cathode lead away from sprocket hole.

4.2

*500 mW Leadless DO-34 Glass
Zener Voltage Regulator Diodes*
**GENERAL DATA APPLICABLE TO ALL SERIES IN
THIS GROUP**
**500 mW Hermetically Sealed
Glass Silicon Zener Diodes**

**GENERAL
DATA**
**500 mW
LEADLESS
DO-34**

**LEADLESS
GLASS ZENER DIODES
500 MILLIWATTS
1.8-56 VOLTS**

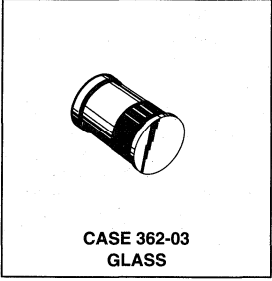

Specification Features:

- Complete Voltage Range — 1.8 to 56 Volts
- Leadless Package for Surface Mount Technology
- Double Slug Type Construction
- Metallurgically Bonded Construction
- Oxide Passivated Die

Mechanical Characteristics:

CASE: Double slug type, hermetically sealed glass

MAXIMUM LEAD TEMPERATURE FOR SOLDERING PURPOSES: 230°C,
for 10 seconds

FINISH: All external surfaces are corrosion resistant and readily solderable

POLARITY: Cathode indicated by color band. When operated in zener mode, cathode
will be positive with respect to anode

MOUNTING POSITION: Any

4

MAXIMUM RATINGS			
Rating	Symbol	Value	Unit
DC Power Dissipation @ $T_A \leq 50^\circ\text{C}$ Derate above $T_A = 50^\circ\text{C}$	P_D	500 3.3	mW mW/°C
Operating and Storage Junction Temperature Range	T_J, T_{stg}	- 65 to +200	°C

4.2

STEADY STATE POWER DERATING

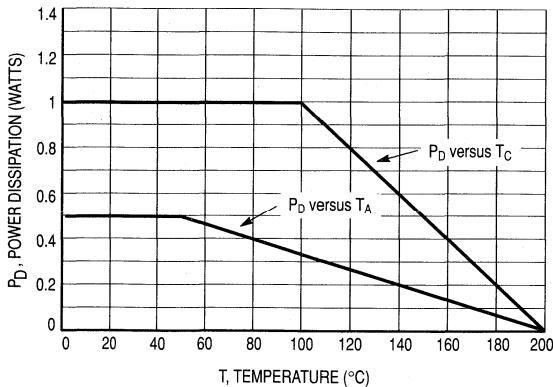

GENERAL DATA — 500 mW LEADLESS DO-34

APPLICATION NOTE

Since the actual voltage available from a given zener diode is temperature dependent, it is necessary to determine junction temperature under any set of operating conditions in order to calculate its value. The following procedure is recommended:

Case Temperature, T_C , should be determined from:

$$T_C = \theta_{CA} P_D + T_A$$

θ_{CA} is the case-to-ambient thermal resistance ($^{\circ}\text{C}/\text{W}$) and P_D is the power dissipation. The value for θ_{CA} will vary and depends on the device mounting method. θ_{CA} is generally $200^{\circ}\text{C}/\text{W}$ for the various clips and tie points in common use and for printed circuit board wiring.

The temperature of the case can also be measured using a thermocouple placed at the case end as close as possible to the tie point. The thermal mass connected to the tie point is normally large enough so that it will not significantly respond to heat surges generated in the diode as a result of pulsed operation once steady-state conditions are achieved. Using the measured value of T_C , the junction temperature may be determined by:

$$T_J = T_C + \Delta T_{JC}$$

ΔT_{JC} is the increase in junction temperature above the case temperature and may be found by using:

$$\Delta T_{JC} = \theta_{JC} P_D$$

For worst-case design, using expected limits of I_Z , limits of P_D and the extremes of T_J (ΔT_J) may be estimated. Changes in voltage, V_Z , can then be found from:

$$\Delta V = \theta_{VZ} \Delta T_J$$

θ_{VZ} , the zener voltage temperature coefficient, is found from Figures 3 and 4.

Under high power-pulse operation, the zener voltage will vary with time and may also be affected significantly by the zener resistance. For best regulation, keep current excursions as low as possible.

Surge limitations are given in Figure 6. They are lower than would be expected by considering only junction temperature, as current crowding effects cause temperatures to be extremely high in small spots resulting in device degradation should the limits of Figure 6 be exceeded.

TYPICAL CHARACTERISTICS

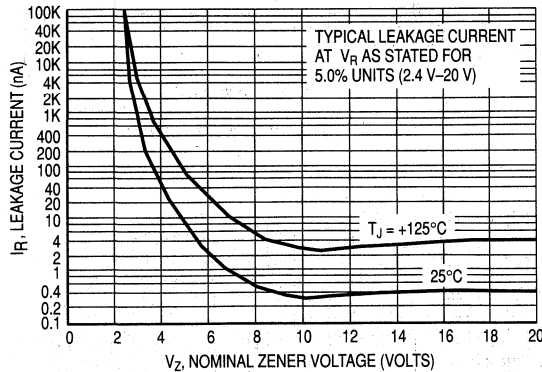

Figure 1. Typical Leakage Current

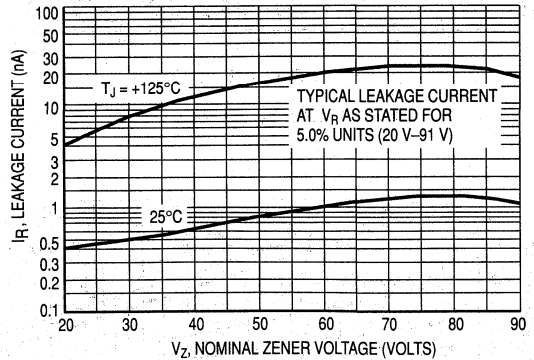

Figure 2. Typical Leakage Current

GENERAL DATA — 500 mW LEADLESS DO-34

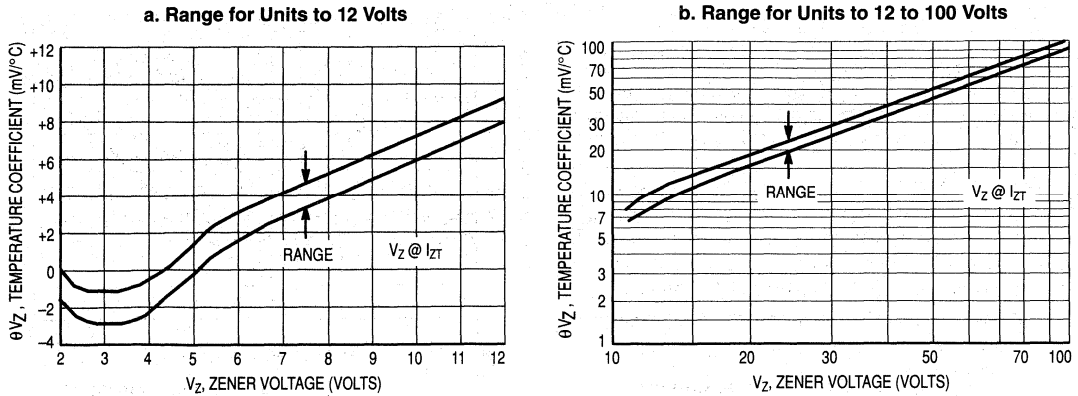

Figure 3. Temperature Coefficients
 (-55°C to +150°C temperature range; 90% of the units are in the ranges indicated.)

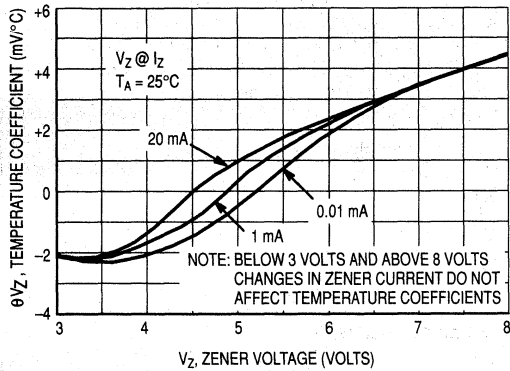

Figure 4. Effect of Zener Current

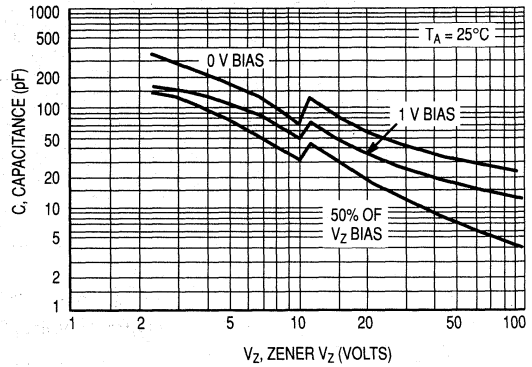
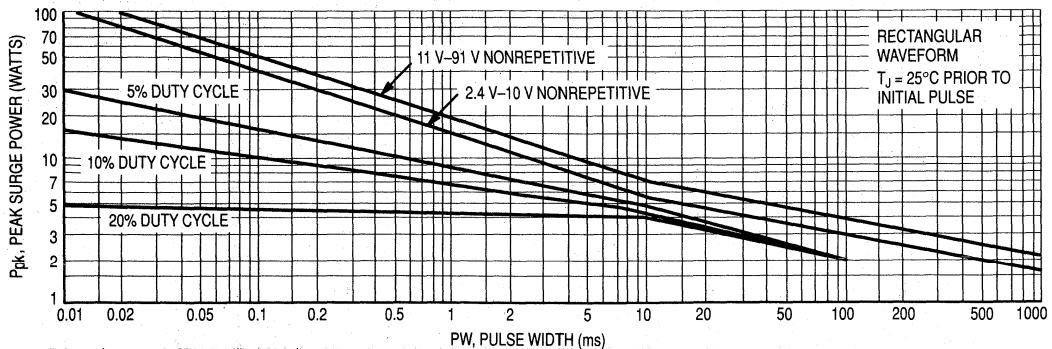

Figure 5. Typical Capacitance



This graph represents 90 percentile data points.
 For worst case design characteristics, multiply surge power by 2/3.

Figure 6. Maximum Surge Power

GENERAL DATA — 500 mW LEADLESS DO-34

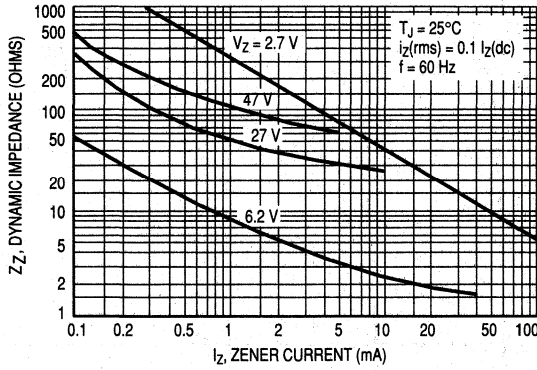

Figure 7. Effect of Zener Current on Zener Impedance

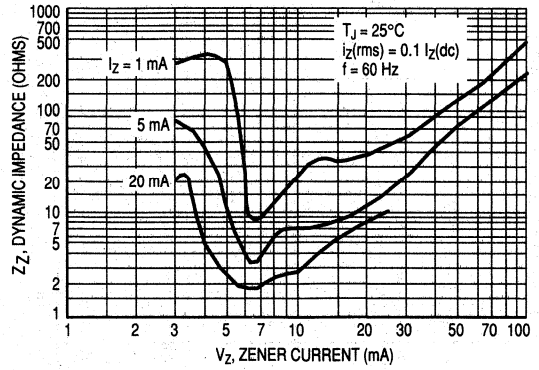

Figure 8. Effect of Zener Voltage on Zener Impedance

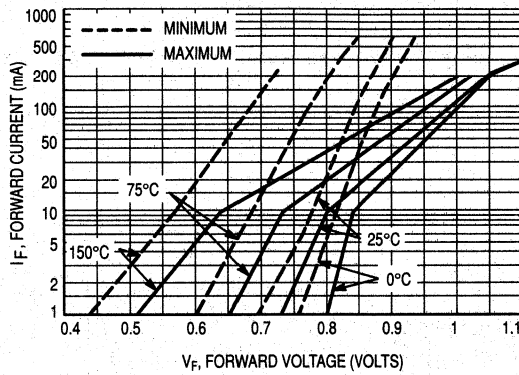

Figure 9. Typical Forward Characteristics

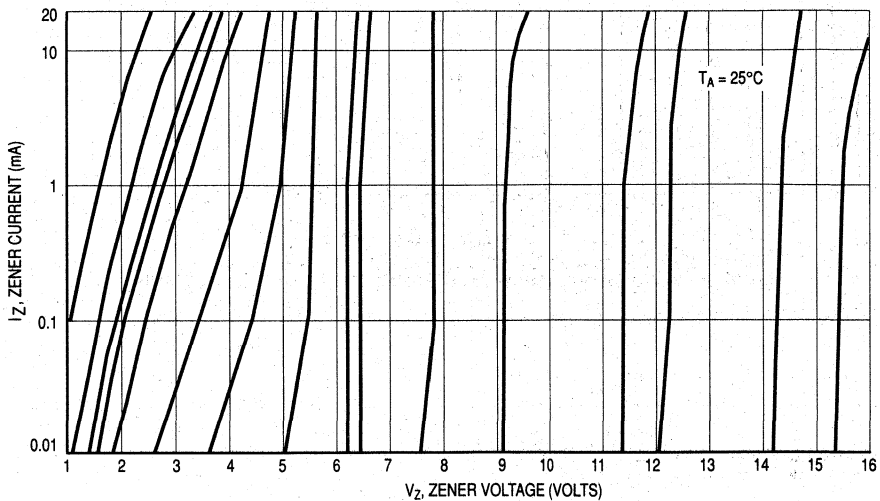

Figure 10. Zener Voltage versus Zener Current — $V_z = 1$ thru 16 Volts

4

4.2

GENERAL DATA — 500 mW LEADLESS DO-34

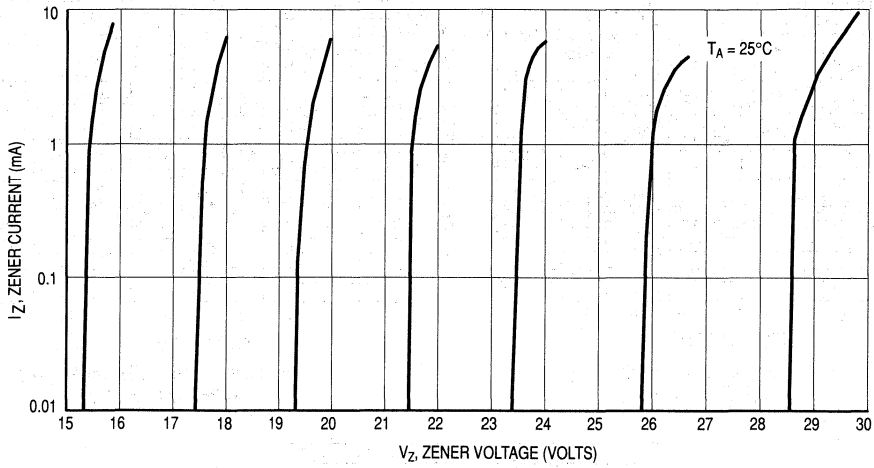

Figure 11. Zener Voltage versus Zener Current — $V_Z = 15$ thru 30 Volts

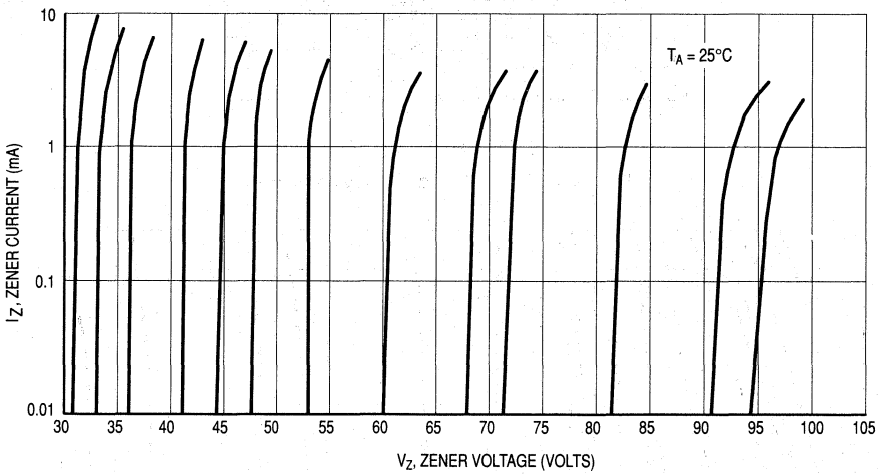

Figure 12. Zener Voltage versus Zener Current — $V_Z = 30$ thru 105 Volts

BZV55C2V4 thru BZV55C56

ELECTRICAL CHARACTERISTICS ($V_F = 0.9 \text{ V Max}$ @ $I_F = 10 \text{ mA}$ for all types)												
Type Number	Zener Voltage V_{Z1} (Volts) @ $I_{Z1} = 5 \text{ mA}$ (Note 1)			Max Zener Impedance Z_{Z11} (Ohms) @ $I_{Z1} = 5 \text{ mA}$	Max Reverse Leakage Current		Zener Voltage V_{Z2} (Volts) @ $I_{Z2} = 1 \text{ mA}$ (Note 1)		Max Zener Impedance Z_{Z12} (Ohms) @ $I_{Z12} = 1 \text{ mA}$	Zener Voltage V_{Z3} (Volts) @ $I_{Z3} = 20 \text{ mA}$ (Note 1)		Max Zener Impedance Z_{Z13} (Ohms) @ $I_{Z13} = 20 \text{ mA}$
	Nom	Min	Max		I_R μA	@ V_R Volts	Min	Max		Min	Max	
BZV55C2V4	2.4	2.2	2.6	100	50	1	1.7	2.1	600	2.6	3.2	50
BZV55C2V7	2.7	2.5	2.9	100	20	1	1.9	2.4	600	3	3.6	50
BZV55C3V0	3	2.8	3.2	95	10	1	2.1	2.7	600	3.3	3.9	50
BZV55C3V3	3.3	3.1	3.5	95	5	1	2.3	2.9	600	3.6	4.2	40
BZV55C3V6	3.6	3.4	3.8	90	5	1	2.7	3.3	600	3.9	4.5	40
BZV55C3V9	3.9	3.7	4.1	90	3	1	2.9	3.5	600	4.1	4.7	30
BZV55C4V3	4.3	4	4.6	90	3	1	3.3	4	600	4.4	5.1	30
BZV55C4V7	4.7	4.4	5	80	3	2	3.7	4.7	500	4.5	5.4	15
BZV55C5V1	5.1	4.8	5.4	60	2	2	4.2	5.3	480	5	5.9	15
BZV55C5V6	5.6	5.2	6	40	1	2	4.8	6	400	5.2	6.3	10
BZV55C6V2	6.2	5.8	6.6	10	3	4	5.6	6.6	150	5.8	6.8	6
BZV55C6V8	6.8	6.4	7.2	15	2	4	6.3	7.2	80	6.4	7.4	6
BZV55C7V5	7.5	7	7.9	15	1	5	6.9	7.9	80	7	8	6
BZV55C8V2	8.2	7.7	8.7	15	0.7	5	7.6	8.7	80	7.7	8.8	6
BZV55C9V1	9.1	8.5	9.6	15	0.5	6	8.4	9.6	100	8.5	9.7	8
BZV55C10	10	9.4	10.6	20	0.2	7	9.3	10.6	150	9.4	10.7	10
BZV55C11	11	10.4	11.6	20	0.1	8	10.2	11.6	150	10.4	11.8	10
BZV55C12	12	11.4	12.7	25	0.1	8	11.2	12.7	150	11.4	12.9	10
BZV55C13	13	12.4	14.1	30	0.1	8	12.3	14	170	12.5	14.2	15
BZV55C15	15	13.8	15.6	30	0.05	10.5	13.7	15.5	200	13.9	15.7	20
BZV55C16	16	15.3	17.1	40	0.05	11.2	15.2	17	200	15.4	17.2	20
BZV55C18	18	16.8	19.1	45	0.05	12.6	16.7	19	225	16.9	19.2	20
BZV55C20	20	18.8	21.2	55	0.05	14	18.7	21.1	225	18.9	21.4	20
BZV55C22	22	20.8	23.3	55	0.05	15.4	20.7	23.2	250	20.9	23.4	25
BZV55C24	24	22.8	25.6	70	0.05	16.8	22.7	25.5	250	22.9	25.7	25
	V_{Z1} Below @ $I_{Z1} = 2 \text{ mA}$			Z_{Z11} Below @ $I_{Z1} = 2 \text{ mA}$			V_{Z2} Below @ $I_{Z2} = 0.1 \text{ mA}$		Z_{Z12} Below @ $I_{Z12} = 0.5 \text{ mA}$ (Note 2)	V_{Z3} Below @ $I_{Z3} = 10 \text{ mA}$		Z_{Z13} Below @ $I_{Z13} = 10 \text{ mA}$
BZV55C27	27	25.1	28.9	80	0.05	18.9	25	28.9	300	25.2	29.3	45
BZV55C30	30	28	32	80	0.05	21	27.8	32	300	28.1	32.4	50
BZV55C33	33	31	35	80	0.05	23.1	30.8	35	325	31.1	35.4	55
BZV55C36	36	34	38	90	0.05	25.2	33.8	38	350	34.1	38.4	60
BZV55C39	39	37	41	130	0.05	27.3	36.7	41	350	37.1	41.5	70
BZV55C43	43	40	46	150	0.05	30.1	39.7	46	375	40.1	46.5	80
BZV55C47	47	44	50	170	0.05	32.9	43.7	50	375	44.1	50.5	90
BZV55C51	51	48	54	180	0.05	35.7	47.6	54	400	48.1	54.6	100
BZV55C56	56	52	60	200	0.05	39.2	51.5	60	425	52.1	60.8	110

NOTES: 1. Zener voltage is measured with a pulse test current (I_Z) applied at an ambient temperature of 25°C.

2. The zener impedance, Z_{Z2} , for the 27 through 56 volt types is tested at 0.5 mA rather than the test current of 0.1 mA used for V_{Z2} .

4

4.2

MLL4678 thru MLL4717

Low level oxide passivated zener diodes for applications requiring extremely low operating currents, low leakage, and sharp breakdown voltage.

- Complete Voltage Range — 1.8 to 43 Volts
- Zener Voltage Specified @ $I_{ZT} = 50 \mu\text{A}$
- Leadless Package for Surface Mount Technology
- Maximum Delta V_Z Given from 10 to 100 μA

ELECTRICAL CHARACTERISTICS ($T_A = 25^\circ\text{C}$, $V_F = 0.9 \text{ V}$ Max at $I_F = 10 \text{ mA}$ for all types)

Type Number (Note 1)	Zener Voltage $V_Z @ I_{ZT} = 50 \mu\text{A}$ Volts			Maximum Reverse Current $I_R \mu\text{A}$	Test Voltage V_R Volts	Maximum Zener Current $I_{ZM} \text{ mA}$ (Note 2)	Maximum Voltage Change ΔV_Z Volts (Note 4)
	Nom (Note 5)	Min	Max				
MLL4678	1.8	1.71	1.89	7.5	1	120	0.7
MLL4679	2	1.9	2.1	5	1	110	0.7
MLL4680	2.2	2.09	2.31	4	1	100	0.75
MLL4681	2.4	2.28	2.52	2	1	95	0.8
MLL4682	2.7	2.565	2.835	1	1	90	0.85
MLL4683	3	2.85	3.15	0.8	1	85	0.9
MLL4684	3.3	3.135	3.465	7.5	1.5	80	0.95
MLL4685	3.6	3.42	3.78	7.5	2	75	0.95
MLL4686	3.9	3.705	4.095	5	2	70	0.97
MLL4687	4.3	4.085	4.515	4	2	65	0.99
MLL4688	4.7	4.465	4.935	10	3	60	0.99
MLL4689	5.1	4.845	5.355	10	3	55	0.97
MLL4690	5.6	5.32	5.88	10	4	50	0.96
MLL4691	6.2	5.89	6.51	10	5	45	0.95
MLL4692	6.8	6.46	7.14	10	5.1	35	0.9
MLL4693	7.5	7.125	7.875	10	5.7	31.8	0.75
MLL4694	8.2	7.79	8.61	1	6.2	29	0.5
MLL4695	8.7	8.265	9.135	1	6.6	27.4	0.1
MLL4696	9.1	8.645	9.555	1	6.9	26.2	0.08
MLL4697	10	9.5	10.5	1	7.6	24.8	0.1
MLL4698	11	10.45	11.55	0.05	8.4	21.6	0.11
MLL4699	12	11.4	12.6	0.05	9.1	20.4	0.12
MLL4700	13	12.35	13.65	0.05	9.8	19	0.13
MLL4701	14	13.3	14.7	0.05	10.6	17.5	0.14
MLL4702	15	14.25	15.75	0.05	11.4	16.3	0.15
MLL4703	16	15.2	16.8	0.05	12.1	15.4	0.16
MLL4704	17	16.15	17.85	0.05	12.9	14.5	0.17
MLL4705	18	17.1	18.9	0.05	13.6	13.2	0.18
MLL4706	19	18.05	19.95	0.05	14.4	12.5	0.19
MLL4707	20	19	21	0.01	15.2	11.9	0.2
MLL4708	22	20.9	23.1	0.01	16.7	10.8	0.22
MLL4709	24	22.8	25.2	0.01	18.2	9.9	0.24
MLL4710	25	23.75	26.25	0.01	19	9.5	0.25
MLL4711	27	25.65	28.35	0.01	20.4	8.8	0.27
MLL4712	28	26.6	29.4	0.01	21.2	8.5	0.28
MLL4713	30	28.5	31.5	0.01	22.8	7.9	0.3
MLL4714	33	31.35	34.65	0.01	25	7.2	0.33
MLL4715	36	34.2	37.8	0.01	27.3	6.6	0.36
MLL4716	39	37.05	40.95	0.01	29.6	6.1	0.39
MLL4717	43	40.85	45.15	0.01	32.6	5.5	0.43

NOTE 1. TOLERANCE AND VOLTAGE DESIGNATION (V_Z)

The type numbers shown have a standard tolerance of $\pm 5\%$ on the nominal zener voltage.

NOTE 2. MAXIMUM ZENER CURRENT RATINGS (I_{ZM})

Maximum zener current ratings are based on maximum zener voltage of the individual units.

NOTE 3. REVERSE LEAKAGE CURRENT (I_R)

Reverse leakage currents are guaranteed and are measured at V_R as shown on the table.

NOTE 4. MAXIMUM VOLTAGE CHANGE (ΔV_Z)

Voltage change is equal to the difference between V_Z at 100 μA and V_Z at 10 μA .

NOTE 5. ZENER VOLTAGE (V_Z) MEASUREMENT

Nominal zener voltage is measured with the device junction in thermal equilibrium at the case temperature of $30^\circ\text{C} \pm 1^\circ\text{C}$.

MLL5221B thru MLL5263B

ELECTRICAL CHARACTERISTICS ($T_A = 25^\circ\text{C}$ unless otherwise noted. Based on dc measurements at thermal equilibrium; case temperature maintained at $30 \pm 2^\circ\text{C}$. $V_F = 0.9$ Max @ $I_F = 10$ mA for all types.)							
Type No. (Note 1)	Nominal Zener Voltage $V_Z @ I_{ZT}$ Volts (Note 2)	Test Current I_{ZT} mA	Max Zener Impedance		Max Reverse Leakage Current		Max Zener Voltage Temperature Coeff. $\theta_{VZ} (\%/^\circ\text{C})$ (Note 3)
			$Z_{ZT} @ I_{ZT}$ Ohms	$Z_{ZK} @ I_{ZK} = 0.25$ mA Ohms	$I_R @ V_R$ μA Volts		
MLL5221B	2.4	20	30	1200	100	1	-0.085
MLL5222B	2.5	20	30	1250	100	1	-0.085
MLL5223B	2.7	20	30	1300	75	1	-0.08
MLL5224B	2.8	20	30	1400	75	1	-0.08
MLL5225B	3	20	29	1600	50	1	-0.075
MLL5226B	3.3	20	28	1600	25	1	-0.07
MLL5227B	3.6	20	24	1700	15	1	-0.065
MLL5228B	3.9	20	23	1900	10	1	-0.06
MLL5229B	4.3	20	22	2000	5	1	± 0.055
MLL5230B	4.7	20	19	1900	5	2	± 0.03
\Rightarrow MLL5231B	5.1	20	17	1600	5	2	± 0.03
MLL5232B	5.6	20	11	1600	5	3	+0.038
\Rightarrow MLL5233B	6	20	7	1600	5	3.5	+0.038
MLL5234B	6.2	20	7	1000	5	4	+0.045
MLL5235B	6.8	20	5	750	3	5	+0.05
MLL5236B	7.5	20	6	500	3	6	+0.058
MLL5237B	8.2	20	8	500	3	6.5	+0.062
MLL5238B	8.7	20	8	600	3	6.5	+0.065
MLL5239B	9.1	20	10	600	3	7	+0.068
MLL5240B	10	20	17	600	3	8	+0.075
MLL5241B	11	20	22	600	2	8.4	+0.076
MLL5242B	12	20	30	600	1	9.1	+0.077
MLL5243B	13	9.5	13	600	0.5	9.9	+0.079
\Rightarrow MLL5244B	14	9	15	600	0.1	10	+0.082
MLL5245B	15	8.5	16	600	0.1	11	+0.082
MLL5246B	16	7.8	17	600	0.1	12	+0.083
MLL5247B	17	7.4	19	600	0.1	13	+0.084
MLL5248B	18	7	21	600	0.1	14	+0.085
MLL5249B	19	6.6	23	600	0.1	14	+0.086
MLL5250B	20	6.2	25	600	0.1	15	+0.086
MLL5251B	22	5.6	29	600	0.1	17	+0.087
\Rightarrow MLL5252B	24	5.2	33	600	0.1	18	+0.088
MLL5253B	25	5	35	600	0.1	19	+0.089
MLL5254B	27	4.6	41	600	0.1	21	+0.09
MLL5255B	28	4.5	44	600	0.1	21	+0.091
MLL5256B	30	4.2	49	600	0.1	23	+0.091
MLL5257B	33	3.8	58	700	0.1	25	+0.092
MLL5258B	36	3.4	70	700	0.1	27	+0.093
MLL5259B	39	3.2	80	800	0.1	30	+0.094
MLL5260B	43	3	93	900	0.1	33	+0.095
MLL5261B	47	2.7	105	1000	0.1	36	+0.095
MLL5262B	51	2.5	125	1100	0.1	39	+0.096
MLL5263B	56	2.2	150	1300	0.1	43	+0.096

(continued)

\Rightarrow Preferred part

(See Notes on the following page)

4

4.2

MLL5221B thru MLL5263B

NOTE 1. TOLERANCE

Units shown indicate a tolerance of $\pm 5\%$.

NOTE 2. SPECIAL SELECTIONS AVAILABLE:

For information on special selections contact your nearest Motorola representative.

NOTE 3. TEMPERATURE COEFFICIENT (θ_{VZ})

Test conditions for temperature coefficient are as follows:

- a. $I_{ZT} = 7.5 \text{ mA}$, $T_1 = 25^\circ\text{C}$,
 $T_2 = 125^\circ\text{C}$ (MLL5221B through MLL5242B).
- b. $I_{ZT} = \text{Rated } I_{ZT}$, $T_1 = 25^\circ\text{C}$,
 $T_2 = 125^\circ\text{C}$ (MLL5243B through MLL5263B).

Device to be temperature stabilized with current applied prior to reading breakdown voltage at the specified ambient temperature.

NOTE 4. ZENER VOLTAGE (V_Z) MEASUREMENT

Nominal zener voltage is measured with the device junction in thermal equilibrium at the case temperature of $30^\circ\text{C} \pm 1^\circ\text{C}$.

NOTE 5. ZENER IMPEDANCE (Z_Z) DERIVATION

Z_{ZT} and Z_{ZK} are measured by dividing the ac voltage drop across the device by the ac current applied. The specified limits are for $I_{Z(ac)} = 0.1 \times I_{Z(dc)}$ with the ac frequency = 1 KHz.

4

4.2

SECTION 4.2.4 DATA SHEETS
ZENER VOLTAGE REGULATOR DIODES — continued

Section 4.2.4.2 Surface Mounted — continued

SECTION 4.2.4.2.3 1.5 WATT DC POWER

DATA SHEETS

Devices	Page No.
1SMB5913BT3 thru 1SMB5956BT3	4-2-78

MULTIPLE PACKAGE QUANTITY (MPQ)
REQUIREMENTS

Package Option	Type No. Suffix	MPQ (Units)
Tape and Reel	T3 ⁽¹⁾	2.5K

NOTE 1. The "3" on the suffix designates reel size (13") and full reel quantity of 2.5K.

1.5 Watt Plastic Surface Mount Silicon Zener Diodes

**1SMB5913BT3
thru
1SMB5956BT3**

... a completely new line of 1.5 Watt Zener Diodes offering the following advantages:

Specification Features:

- A Complete Voltage Range — 3.3 to 200 Volts
- Flat Handling Surface for Accurate Placement
- Package Design for Top Side or Bottom Circuit Board Mounting
- Available in Tape and Reel

Mechanical Characteristics:

CASE: Void-free, transfer-molded plastic

MAXIMUM CASE TEMPERATURE FOR SOLDERING PURPOSES: 230°C for 10 seconds

FINISH: All external surfaces are corrosion resistant with readily solderable leads

POLARITY: Cathode indicated by molded polarity notch. When operated in zener mode, cathode will be positive with respect to anode.

MOUNTING POSITION: Any

WEIGHT: Modified L-Bend providing more contact area to bond pad

**PLASTIC SURFACE MOUNT
ZENER DIODES
1.5 WATTS
3.3–200 VOLTS**

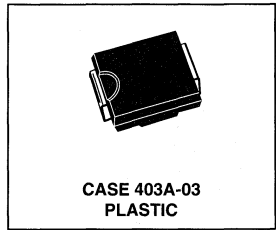

4

MAXIMUM RATINGS			
Rating	Symbol	Value	Unit
DC Power Dissipation @ $T_L = 75^\circ\text{C}$, Measured at Zero Lead Length Derate above 75°C	P_D	1.5 15	Watts mW/°C
Operating and Storage Junction Temperature Range	T_J, T_{stg}	- 65 to +175	°C

4.2

ELECTRICAL CHARACTERISTICS ($T_L = 30^\circ\text{C}$ unless otherwise noted.) ($V_F = 1.5$ Volts Max @ $I_F = 200$ mAdc for all types.)									
Device*	Nominal Zener Voltage $V_Z @ I_{ZT}$ Volts (Note 1)	Test Current I_{ZT} mA	Max Zener Impedance (Note 2)			Max Reverse Leakage Current		Maximum DC Zener Current I_{ZM} mAdc	Device Marking
			$Z_{ZT} @ I_{ZT}$ Ohms	$Z_{ZK} @ I_{ZK}$ Ohms	$I_R @ V_R$ μA	V_R Volts			
1SMB5913BT3	3.3	113.6	10	500	1	100	1	454	913B
1SMB5914BT3	3.6	104.2	9	500	1	75	1	416	914B
1SMB5915BT3	3.9	96.1	7.5	500	1	25	1	384	915B
1SMB5916BT3	4.3	87.2	6	500	1	5	1	348	916B
1SMB5917BT3	4.7	79.8	5	500	1	5	1.5	319	917B
⇒ 1SMB5918BT3	5.1	73.5	4	350	1	5	2	294	918B
1SMB5919BT3	5.6	66.9	2	250	1	5	3	267	919B
⇒ 1SMB5920BT3	6.2	60.5	2	200	1	5	4	241	920B
1SMB5921BT3	6.8	55.1	2.5	200	1	5	5.2	220	921B
1SMB5922BT3	7.5	50	3	400	0.5	5	6.8	200	922B
1SMB5923BT3	8.2	45.7	3.5	400	0.5	5	6.5	182	923B
1SMB5924BT3	9.1	41.2	4	500	0.5	5	7	164	924B
⇒ 1SMB5925BT3	10	37.5	4.5	500	0.25	5	8	150	925B
1SMB5926BT3	11	34.1	5.5	550	0.25	1	8.4	136	926B
⇒ 1SMB5927BT3	12	31.2	6.5	550	0.25	1	9.1	125	927B
1SMB5928BT3	13	28.8	7	550	0.25	1	9.9	115	928B

(continued)

⇒ Preferred part

*TOLERANCE AND VOLTAGE DESIGNATION Tolerance designation — The type numbers listed indicate a tolerance of ±5%.

1SMB5913BT3 Series

ELECTRICAL CHARACTERISTICS — continued ($T_L = 30^\circ\text{C}$ unless otherwise noted.) ($V_F = 1.5$ Volts Max @ $I_F = 200$ mAdc for all types.)

Device*	Nominal Zener Voltage $V_Z @ I_{ZT}$ Volts (Note 1)	Test Current I_{ZT} mA	Max Zener Impedance (Note 2)			Max Reverse Leakage Current		Maximum DC Zener Current I_{ZM} mAdc	Device Marking
			$Z_{ZT} @ I_{ZT}$ Ohms	$Z_{ZK} @ I_{ZK}$ Ohms	I_{ZK} mA	$I_R @ V_R$ μA	V_R Volts		
\Rightarrow 1SMB5929BT3	15	25	9	600	0.25	1	11.4	100	929B
1SMB5930BT3	16	23.4	10	600	0.25	1	12.2	93	930B
\Rightarrow 1SMB5931BT3	18	20.8	12	650	0.25	1	13.7	83	931B
1SMB5932BT3	20	18.7	14	650	0.25	1	15.2	75	932B
1SMB5933BT3	22	17	17.5	650	0.25	1	16.7	68	933B
\Rightarrow 1SMB5934BT3	24	15.6	19	700	0.25	1	18.2	62	934B
1SMB5935BT3	27	13.9	23	700	0.25	1	20.6	55	935B
\Rightarrow 1SMB5936BT3	30	12.5	26	750	0.25	1	22.8	50	936B
1SMB5937BT3	33	11.4	33	800	0.25	1	25.1	45	937B
1SMB5938BT3	36	10.4	38	850	0.25	1	27.4	41	938B
1SMB5939BT3	39	9.6	45	900	0.25	1	29.7	38	939B
1SMB5940BT3	43	8.7	53	950	0.25	1	32.7	34	940B
1SMB5941BT3	47	8	67	1000	0.25	1	35.8	31	941B
1SMB5942BT3	51	7.3	70	1100	0.25	1	38.8	29	942B
1SMB5943BT3	56	6.7	86	1300	0.25	1	42.6	26	943B
1SMB5944BT3	62	6	100	1500	0.25	1	47.1	24	944B
1SMB5945BT3	68	5.5	120	1700	0.25	1	51.7	22	945B
1SMB5946BT3	75	5	140	2000	0.25	1	56	20	946B
1SMB5947BT3	82	4.6	160	2500	0.25	1	62.2	18	947B
1SMB5948BT3	91	4.1	200	3000	0.25	1	69.2	16	948B
1SMB5949BT3	100	3.7	250	3100	0.25	1	76	15	949B
1SMB5950BT3	110	3.4	300	4000	0.25	1	83.6	13	950B
1SMB5951BT3	120	3.1	380	4500	0.25	1	91.2	12	951B
1SMB5952BT3	130	2.9	450	5000	0.25	1	98.8	11	952B
1SMB5953BT3	150	2.5	600	6000	0.25	1	114	10	953B
1SMB5954BT3	160	2.3	700	6500	0.25	1	121.6	9	954B
1SMB5955BT3	180	2.1	900	7000	0.25	1	136.8	8	955B
1SMB5956BT3	200	1.9	1200	8000	0.25	1	152	7	956B

\Rightarrow Preferred part

*TOLERANCE AND VOLTAGE DESIGNATION Tolerance designation — The type numbers listed indicate a tolerance of $\pm 5\%$.

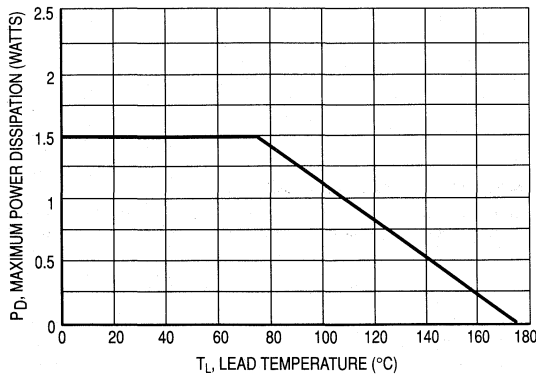

Figure 1. Steady State Power Derating

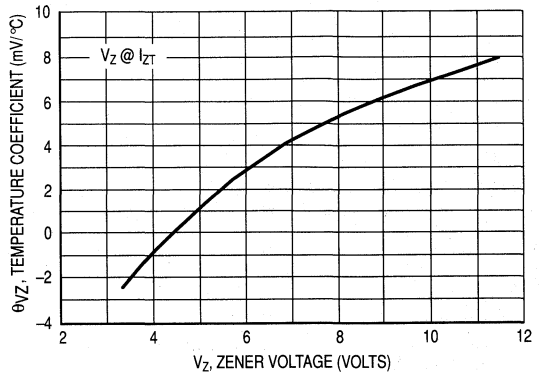

Figure 2. Zener Voltage — To 12 Volts

1SMB5913BT3 Series

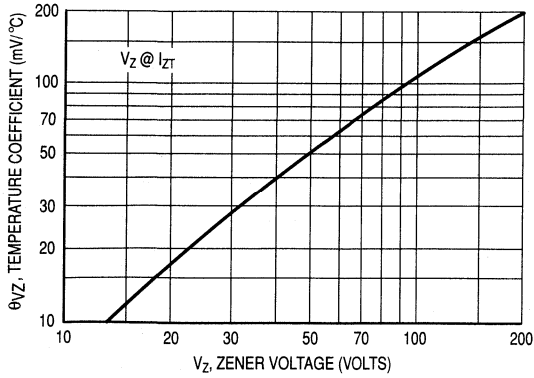

Figure 3. Zener Voltage — 14 To 200 Volts

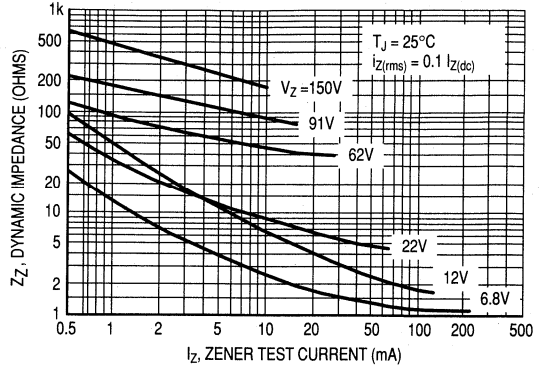

Figure 4. Effect of Zener Current

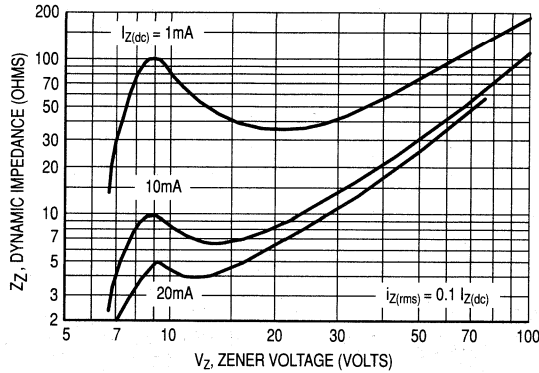

Figure 5. Effect of Zener Voltage

NOTE 1. ZENER VOLTAGE (V_Z) MEASUREMENT

Nominal zener voltage is measured with the device junction in thermal equilibrium with ambient temperature at 25°C.

NOTE 2. ZENER IMPEDANCE (Z_Z) DERIVATION

Z_{ZT} and Z_{ZK} are measured by dividing the ac voltage drop across the device by the ac current applied. The specified limits are for $I_Z(ac) = 0.1 I_Z(dc)$ with the ac frequency = 60 Hz.

Section 4.3

Zener Voltage Reference Diodes

Section	Page
4.3.1 Selector Guide	4-3-2
4.3.2 Data Sheet Category Listing	4-3-5
4.3.3 Alphanumeric Part Number Listing ...	4-3-7
4.3.4 Data Sheets	4-3-9

Section 4.3.1 Selector Guide

Zener Voltage Reference Diodes

4

4.3

SELECTOR GUIDE

Voltage Reference Diodes

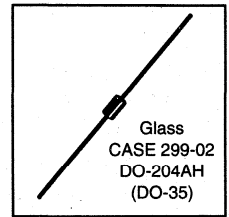

Temperature Compensated Reference Devices

For applications where output voltage must remain within narrow limits during changes in input voltage, load resistance and temperature. Motorola guarantees all reference devices to fall within the specified maximum voltage variations, ΔV_z , at the specifically indicated test temperatures and test current

(JEDEC Standard #5). Temperature coefficient is also specified but should be considered as a reference only — not a maximum rating.

Devices in this table are hermetically sealed structures.

(See Section 4.3.4 for complete data)

V _z Volts	Test Current mA _{dc}	Test* Temp Points	AVERAGE TEMPERATURE COEFFICIENT OVER THE OPERATING RANGE										Case
			0.01 %/°C		0.005 %/°C		0.002 %/°C		0.001 %/°C		0.0005 %/°C		
			Device Type	ΔV_z Max Volts	Device Type	ΔV_z Max Volts	Device Type	ΔV_z Max Volts	Device Type	ΔV_z Max Volts	Device Type	ΔV_z Max Volts	
6.2 Δ	7.5	A	1N821	0.096	1N823	0.048	1N825	0.019	1N827	0.009	1N829	0.005	299-02
	7.5	A	1N821A	0.096	1N823A	0.048	1N825A	0.019	1N827A	0.009	1N829A	0.005	
6.4	0.5	B	1N4565	0.048	1N4566	0.024	1N4567	0.010	1N4568	0.005	1N4569	0.002	DO-204AH (DO-35) Cathode = Polarity Band
	0.5	A	1N4565A	0.099	1N4566A	0.050	1N4567A	0.020	1N4568A	0.010	1N4569A	0.005	
	1	B	1N4570	0.048	1N4571	0.024	1N4572	0.010	1N4573	0.005	1N4574	0.002	
	1	A	1N4570A	0.099	1N4571A	0.050	1N4572A	0.020	1N4573A	0.010	1N4574A	0.005	

Δ Non-suffix — Z_{TI} = 15 ohms, "A" Suffix — Z_{TI} = 10 ohms

*Test Temperature Points °C: A = -55, 0, +25, +75, +100 B = 0, +25, +75

4

4.3

4

4.3

Section 4.3.2 Data Sheet Category Listing Zener Voltage Reference Diodes

Section	Data Sheets	Page
4.3.4.1	AXIAL LEADED	4-3-9
4.3.4.1.1	6.2 Volt OTC 400 mW DO-35 ..	4-3-9
	1N821 thru 1N829A	4-3-10
4.3.4.1.2	6.4 Volt OTC 400 mW DO-35 ..	4-3-13
	1N4565 thru 1N4574A	4-3-14

4

4.3

Section 4.3.3 Alphanumeric Part Number Listing Zener Voltage Reference Diodes

4

4.3

ALPHANUMERIC INDEX – ZENER VOLTAGE REFERENCE DIODES

DEVICE	PAGE
1N821	4-3-10
1N821A	4-3-10
1N823	4-3-10
1N823A	4-3-10
1N825	4-3-10
1N825A	4-3-10
1N827	4-3-10
1N827A	4-3-10
1N829	4-3-10
1N829A	4-3-10

DEVICE	PAGE
1N4565	4-3-15
1N4565A	4-3-15
1N4566	4-3-15
1N4566A	4-3-15
1N4567	4-3-15
1N4567A	4-3-15
1N4568	4-3-15
1N4568A	4-3-15
1N4569	4-3-15
1N4569A	4-3-15

DEVICE	PAGE
1N4570	4-3-15
1N4570A	4-3-15
1N4571	4-3-15
1N4571A	4-3-15
1N4572	4-3-15
1N4572A	4-3-15
1N4573	4-3-15
1N4573A	4-3-15
1N4574	4-3-15
1N4574A	4-3-15

4

4.3

Section 4.3.4 Data Sheets

Zener Voltage Reference Diodes

Section 4.3.4.1 Axial Leaded

SECTION 4.3.4.1.1 6.2 VOLT OTC 400 mW DO-35

DATA SHEETS

Devices	Page No.
1N821 thru 1N829A	4-3-10

MULTIPLE PACKAGE QUANTITY (MPQ) REQUIREMENTS

Package Option	Type No. Suffix	MPQ (Units)
Tape and Reel	RL, RL2 ⁽¹⁾	5K
Tape and Ammo	TA, TA2 ⁽¹⁾	5K

NOTE: 1. The "2" suffix designates 26 mm tape spacing.

Temperature-Compensated Zener Reference Diodes

1N821,A 1N823,A
 1N825,A 1N827,A
 1N829,A

Temperature-compensated zener reference diodes utilizing a single chip oxide passivated junction for long-term voltage stability. A rugged, glass-enclosed, hermetically sealed structure.

Mechanical Characteristics:

CASE: Hermetically sealed, all-glass

DIMENSIONS: See outline drawing.

FINISH: All external surfaces are corrosion resistant and leads are readily solderable.

POLARITY: Cathode indicated by polarity band.

WEIGHT: 0.2 Gram (approx.)

MOUNTING POSITION: Any

TEMPERATURE-COMPENSATED SILICON ZENER REFERENCE DIODES
 6.2 V, 400 mW

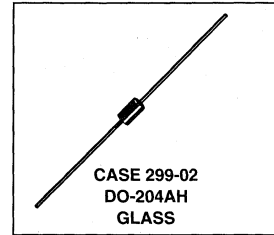

Maximum Ratings

Junction Temperature: - 55 to +175°C

Storage Temperature: - 65 to +175°C

DC Power Dissipation: 400 mW @ $T_A = 50^\circ\text{C}$

ELECTRICAL CHARACTERISTICS ($T_A = 25^\circ\text{C}$ unless otherwise noted. $V_Z = 6.2 \text{ V} \pm 5\%$ * @ $I_{ZT} = 7.5 \text{ mA}$) (Note 5)

JEDEC Type No.	Maximum Voltage Change ΔV_Z (Volts) (Note 1)	Ambient Test Temperature $^\circ\text{C}$ $\pm 1^\circ\text{C}$	Temperature Coefficient For Reference Only %/ $^\circ\text{C}$ (Note 1)	Maximum Dynamic Impedance Z_{ZT} Ohms (Note 2)
\Rightarrow 1N821	0.096	- 55, 0, +25, +75, +100	0.01	15
\Rightarrow 1N823	0.048		0.005	
\Rightarrow 1N825	0.019		0.002	
1N827	0.009		0.001	
1N829	0.005		0.0005	
1N821A	0.096	- 55, 0, +25, +75, +100	0.01	10
1N823A	0.048		0.005	
1N825A	0.019		0.002	
1N827A	0.009		0.001	
1N829A	0.005		0.0005	

\Rightarrow Preferred part

*Tighter-tolerance units available on special request.

1N821 thru 1N829A

MAXIMUM VOLTAGE CHANGE versus AMBIENT TEMPERATURE

(with $I_{ZT} = 7.5 \text{ mA} \pm 0.01 \text{ mA}$) (See Note 3)

1N821 thru 1N829

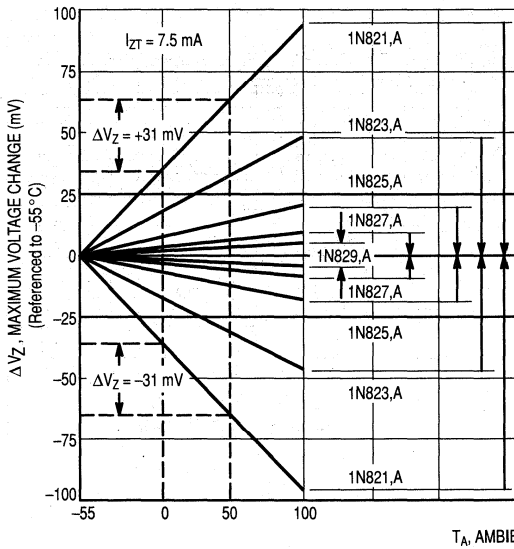

Figure 1a

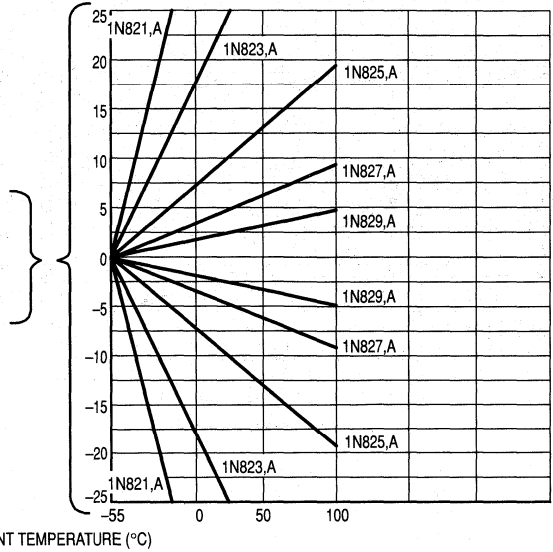

Figure 1b

4

ZENER CURRENT versus MAXIMUM VOLTAGE CHANGE

(At Specified Temperatures)

(See Note 4)

MORE THAN 95% OF THE UNITS ARE IN THE RANGES INDICATED BY THE CURVES.

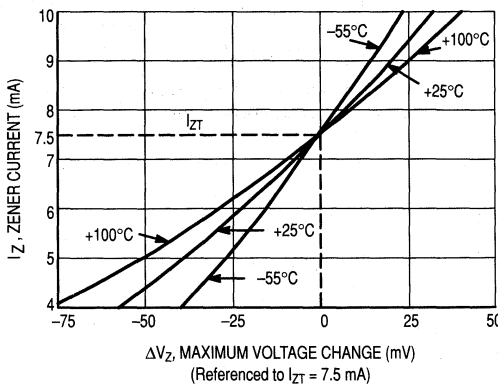

Figure 2. 1N821 Series

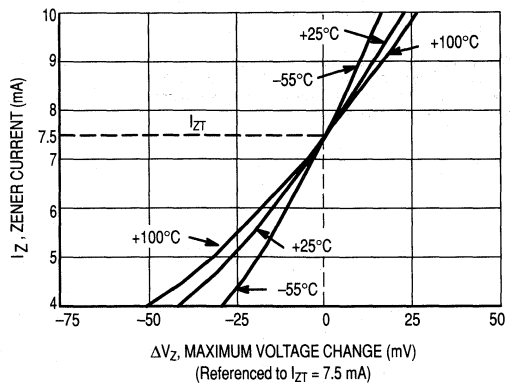

Figure 3. 1N821A Series

4.3

1N821 thru 1N829A

MAXIMUM ZENER IMPEDANCE versus ZENER CURRENT

(See Note 2)

MORE THAN 95% OF THE UNITS ARE IN THE RANGES INDICATED BY THE CURVES.

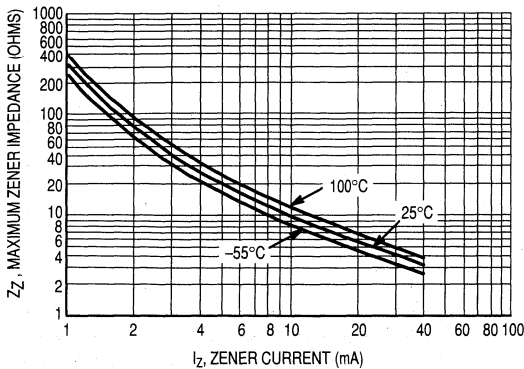

Figure 4. 1N821 Series

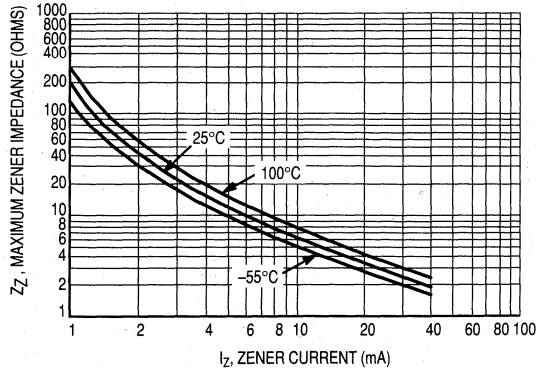

Figure 5. 1N821A Series

4

NOTE 1. VOLTAGE VARIATION (ΔV_z) AND TEMPERATURE COEFFICIENT

All reference diodes are characterized by the "box method." This guarantees a maximum voltage variation (ΔV_z) over the specified temperature range, at the specified test current (I_{ZT}), verified by tests at indicated temperature points within the range. V_z is measured and recorded at each temperature specified. The ΔV_z between the highest and lowest values must not exceed the maximum ΔV_z given. This method of indicating voltage stability is now used for JEDEC registration as well as for military qualification. The former method of indicating voltage stability — by means of temperature coefficient accurately reflects the voltage deviation at the temperature extremes, but is not necessarily accurate within the temperature range because reference diodes have a nonlinear temperature relationship. The temperature coefficient, therefore, is given only as a reference.

NOTE 2.

The dynamic zener impedance, Z_{ZT} , is derived from the 60 Hz ac voltage drop which results when an ac current with an rms value equal to 10% of the dc zener current, I_{ZT} , is superimposed on I_{ZT} . Curves showing the variation of zener impedance with zener current for each series are given in Figures 4 and 5.

4.3

NOTE 3.

These graphs can be used to determine the maximum voltage change of any device in the series over any specific temperature range. For example, a temperature change from 0 to +50°C will cause a voltage change no greater than +31 mV or -31 mV for 1N821 or 1N821A, as illustrated by the dashed lines in Figure 1. The boundaries given are maximum values. For greater resolution, an expanded view of the center area in Figure 1a is shown in Figure 1b.

NOTE 4.

The maximum voltage change, ΔV_z , Figures 2 and 3 is due entirely to the impedance of the device. If both temperature and I_{ZT} are varied, then the total voltage change may be obtained by graphically adding ΔV_z in Figure 2 or 3 to the ΔV_z in Figure 1 for the device under consideration. If the device is to be operated at some stable current other than the specified test current, a new set of characteristics may be plotted by superimposing the data in Figure 2 or 3 on Figure 1. For a more detailed explanation see application note in later section.

NOTE 5.

Zener voltage limits at 25°C measured with the test current (I_{ZT}) applied with the device junction in thermal equilibrium at an ambient temperature of 25°C.

SECTION 4.3.4 DATA SHEETS
ZENER VOLTAGE REFERENCE DIODES — continued

Section 4.3.4.1 Axial Leaded — continued

SECTION 4.3.4.1.2 6.4 VOLT OTC 400 mW DO-35

DATA SHEETS

Devices	Page No.
1N4565 thru 1N4574A	4-3-14

MULTIPLE PACKAGE QUANTITY (MPQ)
REQUIREMENTS

Package Option	Type No. Suffix	MPQ (Units)
Tape and Reel	RL, RL2 ⁽¹⁾	5K
Tape and Ammo	TA, TA2 ⁽¹⁾	5K

NOTE 1. The "2" suffix designates 26 mm tape spacing.

Low-Level Temperature-Compensated Zener Reference Diodes

Highly reliable reference sources utilizing a single chip oxide passivated junction for long-term voltage stability. Glass construction provides a rugged, hermetically sealed structure.

Specification Features:

- Low Power Drain Devices Specified @ 0.5 mA and 1 mA
- Maximum Voltage Change Specified over Test Temperature Range
- Temperature Compensation Guaranteed over Two Standard Operating Temperature Ranges: 0 to 75°C
– 55 to 100°C

Mechanical Characteristics:

CASE: Hermetically sealed, all-glass.

DIMENSIONS: See outline drawing.

FINISH: All external surfaces are corrosion resistant and leads are readily solderable.

POLARITY: Cathode indicated by polarity band.

WEIGHT: 0.2 gram (approx.)

MOUNTING POSITION: Any

**1N4565,A
thru
1N4574,A**

**REFERENCE DIODES
LOW LEVEL
TEMPERATURE-
COMPENSATED ZENER
6.4 V 400 mW**

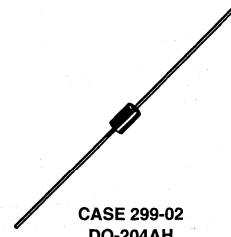

**CASE 299-02
DO-204AH
GLASS**

4

MAXIMUM RATINGS			
Rating	Symbol	Value	Unit
DC Power Dissipation @ $T_A = 50^\circ\text{C}$ Derate above 50°C	P_D	400 3.2	mW mW/ $^\circ\text{C}$
Junction and Storage Temperature Range	T_J, T_{stg}	-65 to +175	$^\circ\text{C}$

4.3

1N4565 thru 1N4574A

ELECTRICAL CHARACTERISTICS					
Type	ΔV_Z (Note 1)	@	Test Temperature	Temperature Coefficient for Reference Only	Dynamic Impedance Ohms Max (Note 2)
	Volts Max		°C	%/°C (Note 1)	
$V_Z = 6.4$ Volts $\pm 5\%$ ($I_{ZT} = 0.5$ mA) at $T_A = 25^\circ\text{C}$ (Note 3)					
1N4565	0.048		0, +25, +75	0.01	200
1N4566	0.024			0.005	
1N4567	0.010			0.002	
1N4568	0.005			0.001	
1N4569	0.002			0.0005	
1N4565A	0.099		-55, 0, +25, +75, +100	0.01	200
1N4566A	0.050			0.005	
1N4567A	0.020			0.002	
1N4568A	0.010			0.001	
1N4569A	0.005			0.0005	
$V_Z = 6.4$ Volts $\pm 5\%$ ($I_{ZT} = 1$ mA) at $T_A = 25^\circ\text{C}$ (Note 3)					
1N4570	0.048		0, +25, +75	0.01	100
1N4571	0.024			0.005	
1N4572	0.010			0.002	
1N4573	0.005			0.001	
1N4574	0.002			0.0005	
1N4570A	0.099		-55, 0, +25, +75, +100	0.01	100
1N4571A	0.050			0.005	
1N4572A	0.020			0.002	
1N4573A	0.010			0.001	
1N4574A	0.005			0.0005	

NOTE 1. VOLTAGE VARIATION (ΔV_Z) AND TEMPERATURE COEFFICIENT

All reference diodes are characterized by the "box method." This guarantees a maximum voltage variation (ΔV_Z) over the specified temperature range, at the specified test current (I_{ZT}), verified by tests at indicated temperature points within the range. This method of indicating voltage stability is now used for JEDEC registration as well as for military qualification. The former method of indicating voltage stability — by means of temperature coefficient — accurately reflects the voltage deviation at the temperature extremes, but is not necessarily accurate within the temperature range because reference diodes have a nonlinear temperature relationship. The temperature coefficient, therefore, is given only as a reference.

NOTE 2.

The dynamic zener impedance, Z_{ZT} , is derived from the 60 Hz ac voltage drop which results when an ac current with an rms value equal to 10% of the dc zener current, I_{ZT} , is superimposed on I_{ZT} .

NOTE 3.

Zener voltage limits of 25°C measured with test current (I_{ZT}) applied with the device junction in thermal equilibrium at an ambient temperature of 25°C .

TVS/Zener Axial-Lead Lead Tape Packaging Standards for Axial-Lead Components

1.0 SCOPE

This section covers packaging requirements for the following axial-lead component's use in automatic testing and assembly equipment: Motorola Case 17-02, Case 41A-02, Case 51-02 (DO-7), Case 59-03 (DO-41), Case 59-04, Case 194-04 and Case 299-02 (DO-35). Packaging, as covered in this section, shall consist of axial-lead components mounted by their leads on pressure sensitive tape, wound onto a reel.

2.0 PURPOSE

This section establishes Motorola standard practices for lead-tape packaging of axial-lead components and meets the requirements of EIA Standard RS-296-D "Lead-taping of Components on Axial Lead Configuration for Automatic Insertion," level 1.

3.0 REQUIREMENTS

3.1 Component leads

3.1.1 – Component leads shall not be bent beyond dimension E from their normal position. See Figure 2.

3.1.2 – The "C" dimension shall be governed by the overall length of the reel packaged component. The distance between flanges shall be 0.059 inch to 0.315 inch greater than the overall component length. See Figures 2 and 3.

3.1.3 – Cumulative dimension "A" tolerance shall not exceed 0.059 over 6 in consecutive components.

3.2 Orientation

All polarized components must be oriented in one direction. The cathode lead tape shall be blue and the anode tape shall be white. See Figure 1.

3.3 Reeling

3.3.1 – Components on any reel shall not represent more than two date codes when date code identification is required.

3.3.2 – Component's leads shall be positioned perpendicularly between pairs of 0.250 inch tape. See Figure 2.

3.3.3 – A minimum 12 inch leader of tape shall be provided before the first and last component on the reel.

3.3.4 – 50 lb. Kraft paper is wound between layers of components as far as necessary for component protection.

3.3.5 – Components shall be centered between tapes such that the difference between D1 and D2 does not exceed 0.055.

3.3.6 – Staples shall not be used for splicing. No more than four layers of tape shall be used in any splice area and no tape shall be offset from another by more than 0.031 inch noncumulative. Tape splices shall overlap at least 6 inches for butt joints and at least 3 inches for lap joints and shall not be weaker than unspliced tape.

3.3.7 – Quantity per reel shall be as indicated in Table 1. Orders for tape and reeled product will only be processed and shipped in full reel increments. Scheduled orders must be in releases of full reel increments or multiples thereof.

3.3.8 – A maximum of 0.25% of the components per reel quantity may be missing without consecutive missing per level 1 of RS-296-D.

3.3.9 – The single face roll pad shall be placed around the finished reel and taped securely. Each reel shall then be placed in an appropriate container.

3.4 Marking

Minimum reel and carton marking shall consist of the following (see Figure 3):

Motorola part number

Quantity

Manufacturer's name

Date codes (when applicable; see note 3.3.1)

4.0

Requirements differing from this Motorola standard shall be negotiated with the factory.

The packages indicated in the following table are suitable for lead tape packaging. The table indicates the specific devices (transient voltage suppressors and/or zeners) that can be obtained from Motorola in reel packaging and provides the appropriate packaging specification.

Lead Tape Packaging Standards for Axial-Lead Components (continued)

Case Type	Product Category	Device Title Suffix	MPQ Quantity Per Reel (Item 3.3.7)	Component Spacing A Dimension	Tape Spacing B Dimension	Reel Dimension C	Reel Dimension D (Max)	Max Off Alignment E
Case 17-02	Surmetic 40 & 600 Watt TVS (Mosorb)	RL	4000	0.2 +/- 0.015	2.062 +/- 0.059	3	14	0.047
Case 41A-02	1500 Watt TVS (Mosorb)	RL4	1500	0.4 +/- 0.02	2.062 +/- 0.059	3	14	0.047
Case 51-02	DO-7 Glass (For Reference only)	RL	3000	0.2 +/- 0.02	2.062 +/- 0.059	3	14	0.047
Case 59-03	DO-41 Glass & DO-41 Surmetic 30	RL	6000	0.2 +/- 0.015	2.062 +/- 0.059	3	14	0.047
Case 59-04	500 Watt TVS (Mosorb)	RL	5000	0.2 +/- 0.02	2.062 +/- 0.059	3	14	0.047
Case 194-04	110 Amp TVS (Automotive)	RL	800	0.4 +/- 0.02	1.875 +/- 0.059	3	14	0.047
Case 299-02	DO-35 Glass	RL	5000	0.2 +/- 0.02	2.062 +/- 0.059	3	14	0.047

Table 1. Packaging Details (all dimensions in inches)

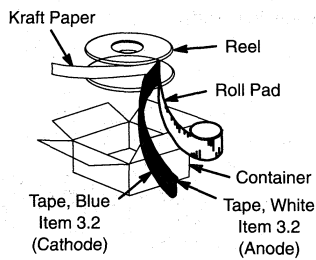

Figure 1. Reel Packing

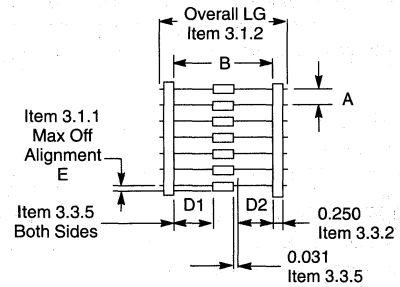

Figure 2. Component Spacing

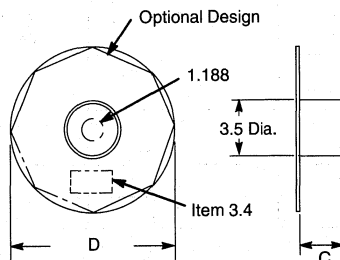

Figure 3. Reel Dimensions

TVS/Zener Surface Mount Embossed Tape and Reel

Embossed Tape and Reel is used to facilitate automatic pick and place equipment feed requirements. The tape is used as the shipping container for various products and requires a minimum of handling. The antistatic/conductive tape provides a secure cavity for the product when sealed with the "peel-back" cover tape.

- Used for Automatic Pick and Place Feed Systems
- Minimizes Product Handling
- EIA 481-1, 8 mm and 12 mm Taping of Surface Mount Components for Automatic Handling and EIA 481-2, 16 mm and 24 mm Embossed Carrier Taping of Surface Mount Components for Automatic Handling
- MLL-34, SOT-23 in 8 mm Tape
- SMB in 12 mm Tape
- SMC in 16 mm Tape

Ordering Information

Use the standard device title and add the required suffix as listed in the option table below. Note that the individual reels have a finite number of devices depending on the type of product contained in the tape. Also note the minimum lot size is one full reel for each line item and orders are required to be in increments of the single reel quantity.

Tape and Reel Data for TVS/Zener Surface Mount Devices

PACKAGES
MLL-34 **SOT-23**
SMB **SMC**

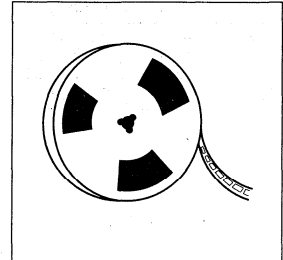

SOT-23
8 mm

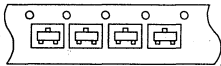

MLL-34
8 mm

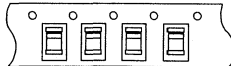

SMB, SMC
12 mm 16 mm

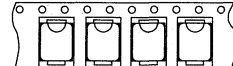

5

Package	Case Type	Tape Width (mm)	Reel Size (inch)	Devices Per Reel and Minimum Order Quantity	Device Suffix
SOT-23	Case 318-07	8	7	3,000	T1
		8	13	10,000	T3
MLL-34	Case 362-03	8	7	2,000	T1
		8	13	5,000	T3
SMB	Case 403A-03	12	13	2,500	T3
SMC	Case 403-03	16	13	2,500	T3

CARRIER TAPE SPECIFICATIONS

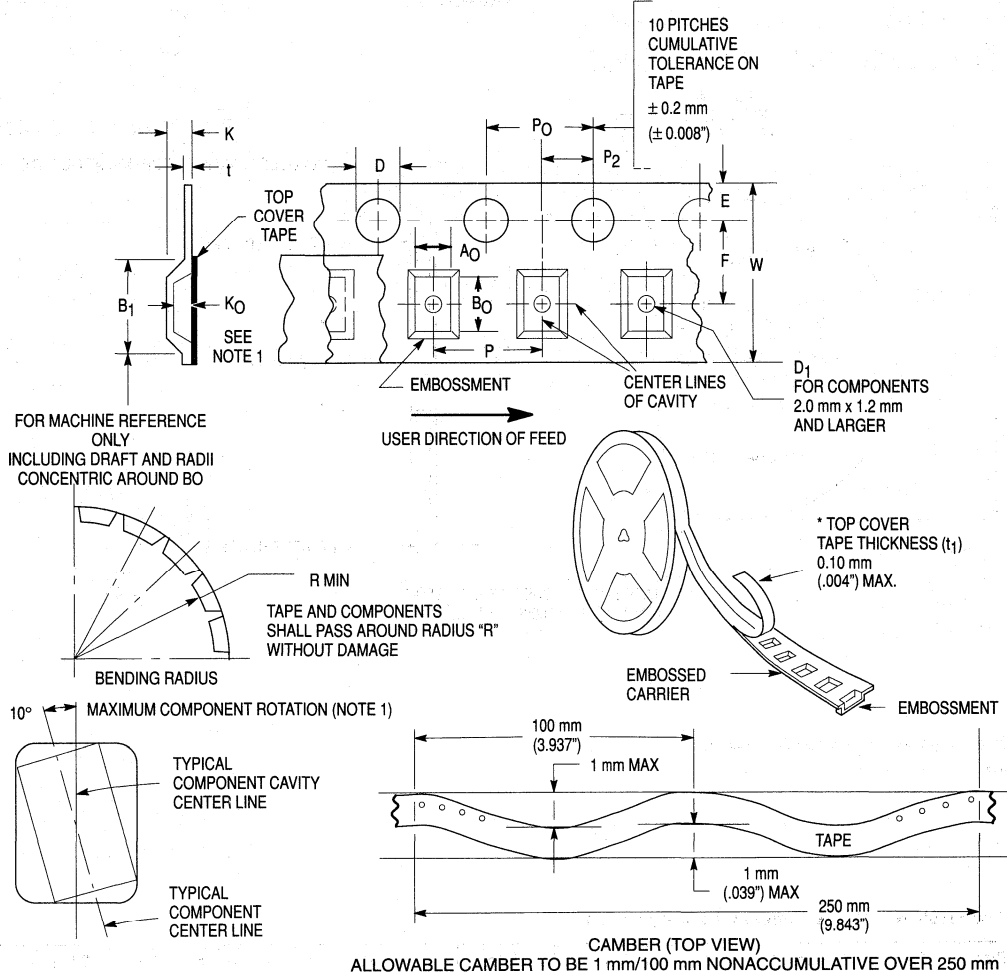

DIMENSIONS (Metric dimensions govern)

Tape Size	Max B1	D	D1	E	F	Max K	P	PO	P2	R Min	Max t	W Max
8mm	4.55mm (.179")	1.5+0.1mm - 0.0 (.059+.004 - 0.0)	1.0mm min (.039")	1.75±0.1mm (.069±.004")	3.5±0.05mm (.138±.002")	2.4mm (.094")	4.0±0.1mm (.157±.004")	4.0±0.1mm (.157±.004")	2.0±0.05mm (.079±.002")	25mm (.98")	0.6mm (.024")	8.3mm (.327")
12mm	8.2mm (.323")		1.5mm min (.060")		5.5±0.05mm (.217±.002")	6.4mm (.252")	8.0±0.1mm (.315±.004")			30mm (1.18")		12.3mm (.484")
16mm	12.1mm (.476")				7.5±0.10mm (.295±.004")	7.9mm (.311")	8.0±.01mm (.315±.004")		2.0±0.1mm (.079±.004")	30mm (1.18")		16.3mm (.642")

Note 1. AO, BO and KO are determined by component size. The clearance between the components and the cavity must be within .05 mm min. to .50 mm max. for 8 mm and 12 mm tape and within 0.15 mm min. to 0.9 mm max. for 16 mm tape. The component cannot rotate more than 10 degrees within the determined cavity.

REEL CONFIGURATION

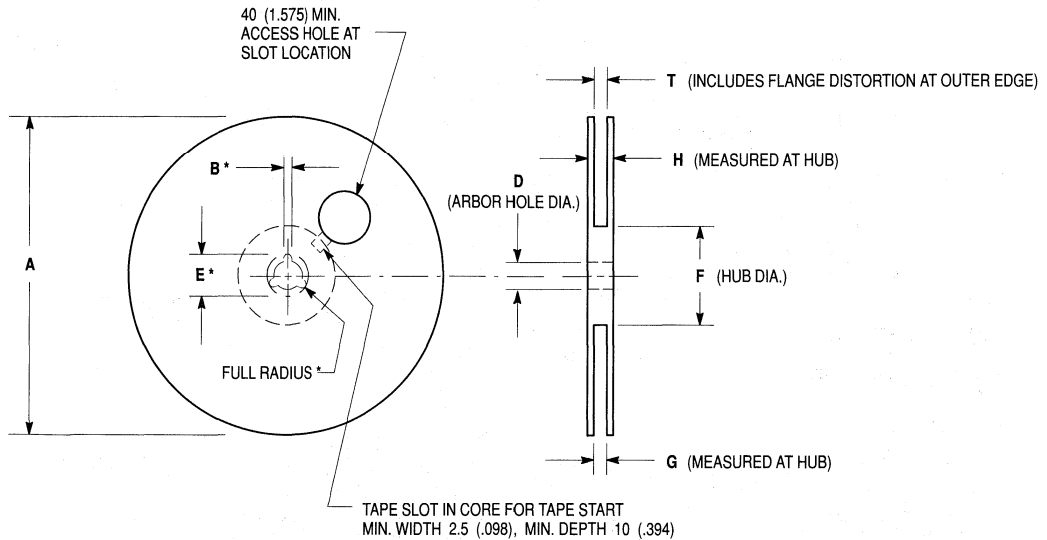

* Optional Drive Spokes, Asterisked Dimensions Apply
Metric dimensions govern

5

REEL DIMENSIONS (Metric dimensions will govern)

Tape Size	A Max. (Note 1)	B* Min.	D	E* Min.	F Min.	G	H Max.	T Max
8 mm	330	1.5	13.0 ± 0.20	20.2	50	8.4 +1.5/-0.0 (.331 +.059/-0.0)	14.4 (.567)	7.9 (.311) Min 10.9 (.429) Max
12 mm	(12.992)	(.059)	(.512 ± .008)	(.795)	(1.969)	12.4 +2.0/-0.0 (.488 +.078/-0.0)	18.4 (.724)	11.9 (.469) Min 15.4 (.607) Max
16 mm	330 (12.992)	1.5 (.059)	13.0 ± 0.20 (.512 ± 0.008)	20.2 (.795)	50 (1.969)	16.4 +2.0/-0.0 (.646 +0.78/-0.0)	22.4 (.882)	15.9 (.626) Min 19.4 (.764) Max

Note 1. For 7" reels, A Max. is 177 mm (6.968").

TAPE LEADER AND TRAILER DIMENSIONS

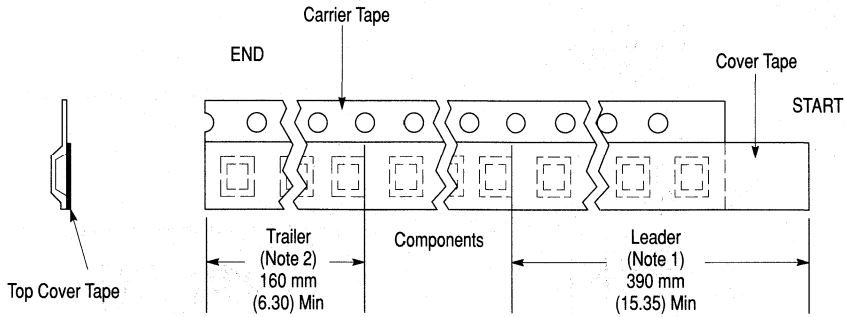

Metric dimensions govern

NOTES

1. There shall be a leader of 230 mm (9.05) minimum which may consist of carrier and/or cover tape followed by a minimum of 160 mm (6.30) of empty carrier tape sealed with cover tape.
2. There shall be a trailer of 160 mm (6.30) minimum of empty carrier tape sealed with cover tape. The entire carrier tape must release from the reel hub as the last portion of the tape unwinds from the reel without damage to the carrier tape and the remaining components in the cavities.

ELECTRICAL POLARIZATION

TWO TERMINATION DEVICES

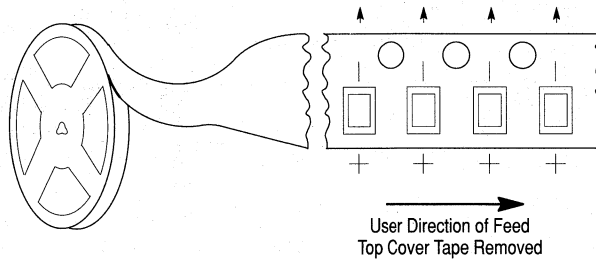

Metric dimensions govern

NOTES

1. All polarized components must be oriented in one direction. For components with two terminations the cathode shall be adjacent to the sprocket hole side.

OUTLINE DIMENSIONS

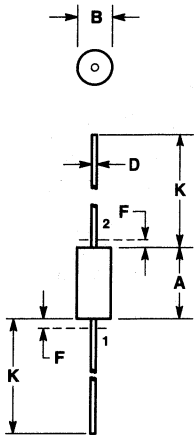

NOTE:
1. LEAD DIAMETER & FINISH NOT CONTROLLED WITHIN DIM "F".

DIM	MILLIMETERS		INCHES	
	MIN	MAX	MIN	MAX
A	8.38	8.89	0.330	0.350
B	3.30	3.68	0.130	0.145
D	0.94	1.09	0.037	0.043
F	—	1.27	—	0.050
K	25.40	31.75	1.000	1.250

CASE 17-02
(Surmetic 40)

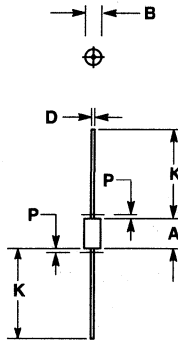

NOTES:
1. DIMENSIONING AND TOLERANCING PER ANSI Y14.5M, 1982.
2. CONTROLLING DIMENSION: INCH.
3. LEAD FINISH AND DIAMETER UNCONTROLLED IN DIM P.

DIM	MILLIMETERS		INCHES	
	MIN	MAX	MIN	MAX
A	9.14	9.52	0.360	0.375
B	4.83	5.21	0.190	0.205
D	0.97	1.07	0.038	0.042
K	25.40	—	1.000	—
P	—	1.27	—	0.050

CASE 41A-02

OUTLINE DIMENSIONS

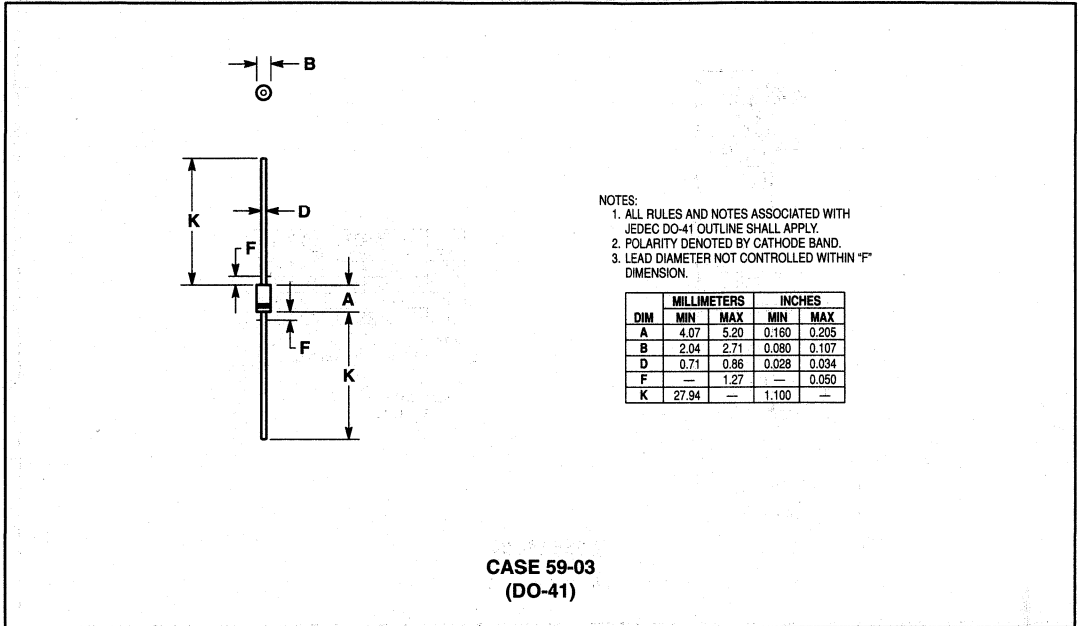

- NOTES:
1. ALL RULES AND NOTES ASSOCIATED WITH JEDEC DO-41 OUTLINE SHALL APPLY.
 2. POLARITY DENOTED BY CATHODE BAND.
 3. LEAD DIAMETER NOT CONTROLLED WITHIN "F" DIMENSION.

DIM	MILLIMETERS		INCHES	
	MIN	MAX	MIN	MAX
A	4.07	5.20	0.160	0.205
B	2.04	2.71	0.080	0.107
D	0.71	0.86	0.028	0.034
F	—	1.27	—	0.050
K	27.94	—	1.100	—

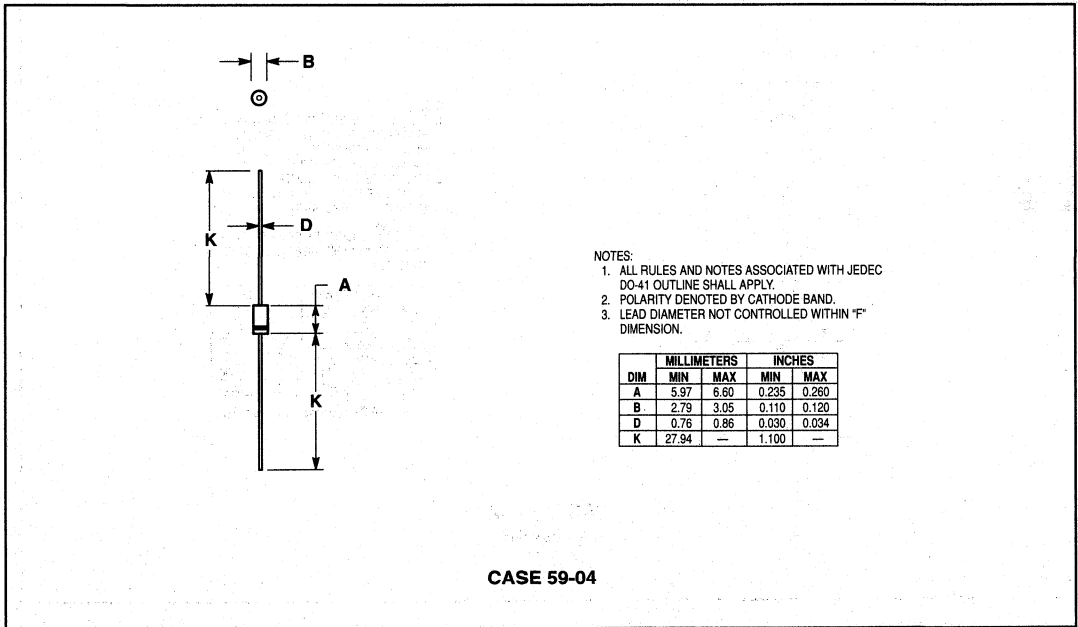

- NOTES:
1. ALL RULES AND NOTES ASSOCIATED WITH JEDEC DO-41 OUTLINE SHALL APPLY.
 2. POLARITY DENOTED BY CATHODE BAND.
 3. LEAD DIAMETER NOT CONTROLLED WITHIN "F" DIMENSION.

DIM	MILLIMETERS		INCHES	
	MIN	MAX	MIN	MAX
A	5.97	6.80	0.235	0.260
B	2.79	3.05	0.110	0.120
D	0.76	0.86	0.030	0.034
K	27.94	—	1.100	—

5

OUTLINE DIMENSIONS

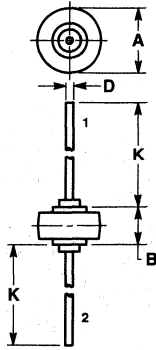

DIM	MILLIMETERS		INCHES	
	MIN	MAX	MIN	MAX
A	8.43	8.69	0.332	0.342
B	5.94	6.25	0.234	0.246
D	1.27	1.35	0.050	0.053
K	25.15	25.65	0.990	1.010

NOTE:
1. CATHODE SYMBOL ON PKG.

STYLE 1:
PIN 1: CATHODE
2: ANODE

CASE 194-04

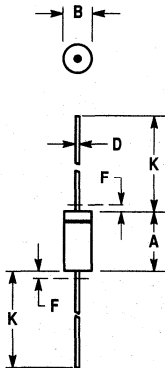

NOTES:
1. PACKAGE CONTOUR OPTIONAL WITHIN A AND B HEAT SLUGS, IF ANY, SHALL BE INCLUDED WITHIN THIS CYLINDER, BUT NOT SUBJECT TO THE MINIMUM LIMIT OF B.
2. LEAD DIAMETER NOT CONTROLLED IN ZONE F TO ALLOW FOR FLASH, LEAD FINISH BUILDUP AND MINOR IRREGULARITIES OTHER THAN HEAT SLUGS.
3. POLARITY DENOTED BY CATHODE BAND.
4. DIMENSIONING AND TOLERANCING PER ANSI Y14.5, 1973.

DIM	MILLIMETERS		INCHES	
	MIN	MAX	MIN	MAX
A	3.05	5.08	0.120	0.200
B	1.52	2.29	0.060	0.090
D	0.46	0.56	0.018	0.022
F	—	1.27	—	0.050
K	25.40	38.10	1.000	1.500

All JEDEC dimensions and notes apply.

**CASE 299-02
DO-204AH
(DO-35)**

OUTLINE DIMENSIONS

NOTES:

1. DIMENSIONING AND TOLERANCING PER ANSI Y14.5M, 1982.
2. CONTROLLING DIMENSION: INCH.
3. MAXIMUM LEAD THICKNESS INCLUDES LEAD FINISH THICKNESS. MINIMUM LEAD THICKNESS IS THE MINIMUM THICKNESS OF BASE MATERIAL.
4. 318-03 OBSOLETE, NEW STANDARD 318-07.

DIM	MILLIMETERS		INCHES	
	MIN	MAX	MIN	MAX
A	2.80	3.04	0.1102	0.1197
B	1.20	1.40	0.0472	0.0551
C	0.89	1.11	0.0350	0.0440
D	0.37	0.50	0.0150	0.0200
G	1.78	2.04	0.0701	0.0807
H	0.013	0.100	0.0005	0.0040
J	0.085	0.177	0.0034	0.0070
K	0.45	0.60	0.0180	0.0236
L	0.89	1.02	0.0350	0.0401
S	2.10	2.50	0.0830	0.0984
V	0.45	0.60	0.0177	0.0236

STYLE 8:

- PIN 1. ANODE
2. NO CONNECTION
3. CATHODE

STYLE 9:

- PIN 1. ANODE
2. ANODE
3. CATHODE

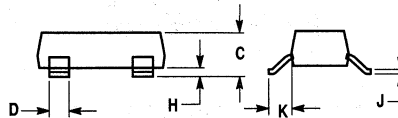
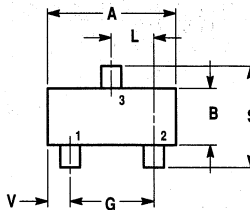

**CASE 318-07
TO-236AB
(SOT-23)**

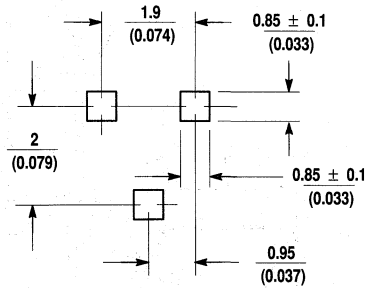

**SOT-23
Solder Pad
Geometry**

mm
(inches)

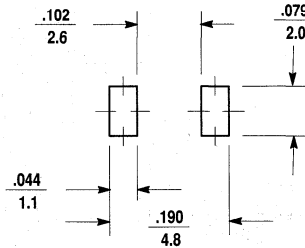
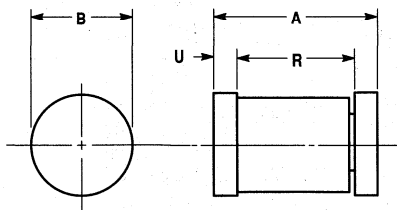

NOTES:

1. DIMENSIONING AND TOLERANCING PER ANSI Y14.5M, 1982.
2. CONTROLLING DIMENSION: INCH.
3. 362-01 OBSOLETE, NEW STANDARD 362-03.

DIM	MILLIMETERS		INCHES	
	MIN	MAX	MIN	MAX
A	3.30	3.70	0.130	0.146
B	1.60	1.73	0.063	0.068
R	2.49	—	0.098	—
U	0.41	0.55	0.016	0.022

**MLL34
Solder Pad
Geometry**

inches
mm

**CASE 362-03
(MLL34)**

OUTLINE DIMENSIONS

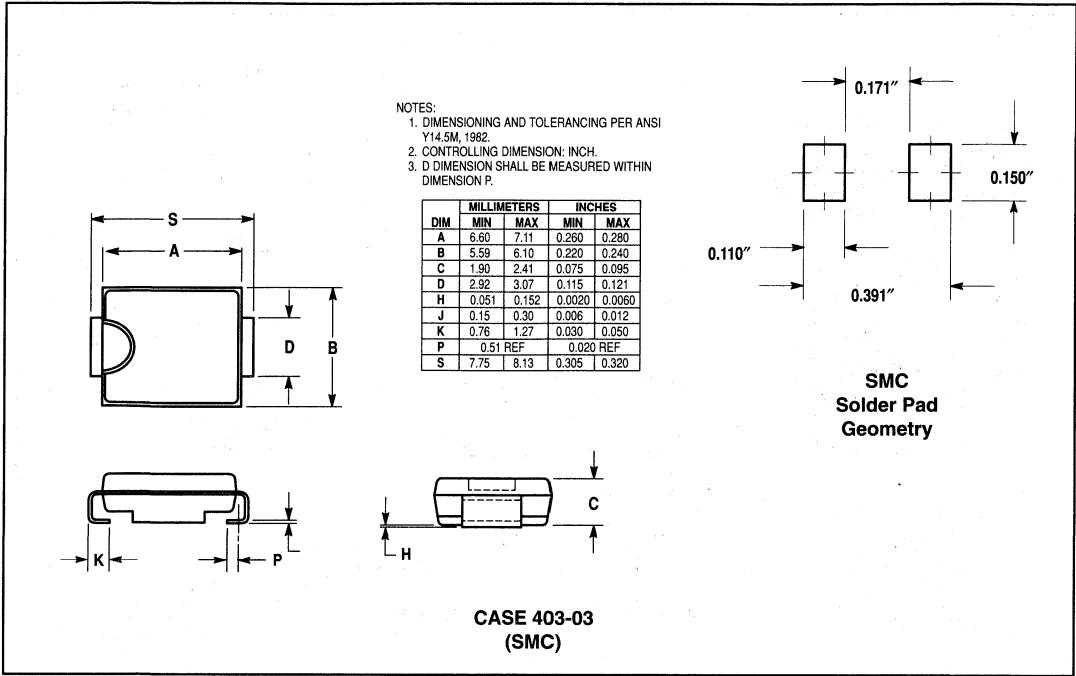

5

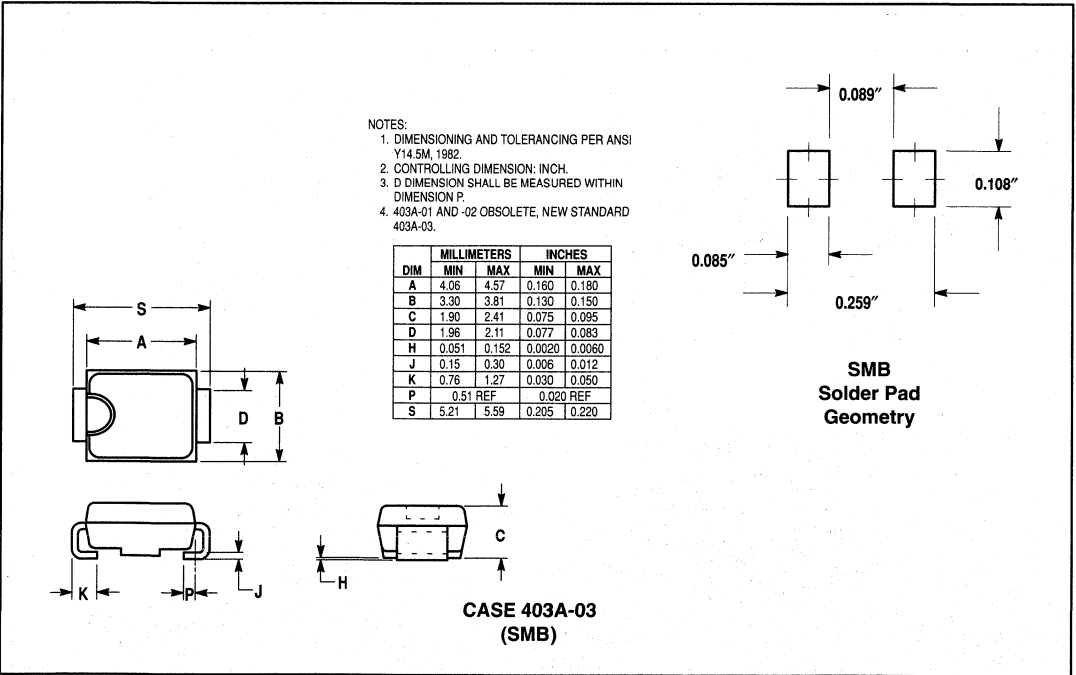

This section contains information edited and updated from the Technical Section of the 1980 edition of the Motorola Zener Diode Manual.

	PAGE
CHAPTER 1	
ZENER DIODE THEORY	6-1-1
CHAPTER 2	
ZENER DIODE FABRICATION TECHNIQUES	6-2-1
CHAPTER 3	
RELIABILITY	6-3-1
CHAPTER 4	
ZENER DIODE CHARACTERISTICS	6-4-1
CHAPTER 5	
TEMPERATURE COMPENSATED ZENERS	6-5-1
CHAPTER 6	
BASIC VOLTAGE REGULATION USING ZENER DIODES	6-6-1
CHAPTER 7	
ZENER PROTECTION CIRCUITS AND TECHNIQUES BASIC DESIGN CONSIDERATIONS ..	6-7-1
CHAPTER 8	
ZENER VOLTAGE SENSING CIRCUITS AND APPLICATIONS	6-8-1
CHAPTER 9	
MISCELLANEOUS APPLICATIONS OF ZENER TYPE DEVICES	6-9-1

CHAPTER 1: ZENER DIODE THEORY

Introduction

The zener diode is a semiconductor device unique in its mode of operation and completely unreplaceable by any other electronic device. Because of its unusual properties it fills a long-standing need in electronic circuitry. It provides, among other useful functions, a constant voltage reference or voltage control element available over a wide spectrum of voltage and power levels.

The zener diode is unique among the semiconductor family of devices because its electrical properties are derived from a rectifying junction which operates in the reverse breakdown region. In the sections that follow, the reverse biased rectifying junction, some of the terms associated with it, and properties derived from it will be discussed fully.

The zener diode is fabricated from the element silicon. Special techniques are applied in the fabrication of zener diodes to create the required properties.

This manual was prepared to acquaint the engineer, the equipment designer and manufacturer, and the experimenter with the fundamental principles, design characteristics, applications and advantages of this important semiconductor device.

Semiconductor Theory

The active portion of a zener diode is a semiconductor PN junction. PN junctions are formed in various kinds of semiconductor devices by several techniques. Among these are the widely used techniques known as alloying and diffusion which are utilized in fabricating zener PN junctions to provide excellent control over zener breakdown voltage.

At the present time, zener diodes use silicon as the basic material in the formation of their PN junction. Silicon is in Group IV of the periodic table (tetravalent) and is classed as a "semiconductor" due to the fact that it is a poor conductor in a pure state. When controlled amounts of certain "impurities" are added to a semiconductor it becomes a better conductor of electricity. Depending on the type of impurity added to the basic semiconductor, its conductivity may take two different forms, called P- and N-type respectively.

N-type conductivity in a semiconductor is much like the conductivity due to the drift of free electrons in a metal. In pure silicon at room temperature there are too few free electrons to conduct current. However, there are ways of introducing free electrons into the crystal lattice as we shall now see. Silicon is a tetravalent element, one with four valence electrons in the outer shell; all are virtually locked into place by the covalent bonds of the crystal lattice structure, as shown schematically in Figure 1-1a. When controlled amounts of donor impurities (Group V elements) such as phosphorus are added, the pentavalent phosphorus atoms entering the lattice structure provide extra electrons not required by the covalent bonds. These impurities are called donor impurities since they "donate" a free electron to the lattice. These donated electrons are free to drift from negative to positive across the crystal when

a field is applied, as shown in Figure 1-1b. The “N” nomenclature for this kind of conductivity implies “negative” charge carriers.

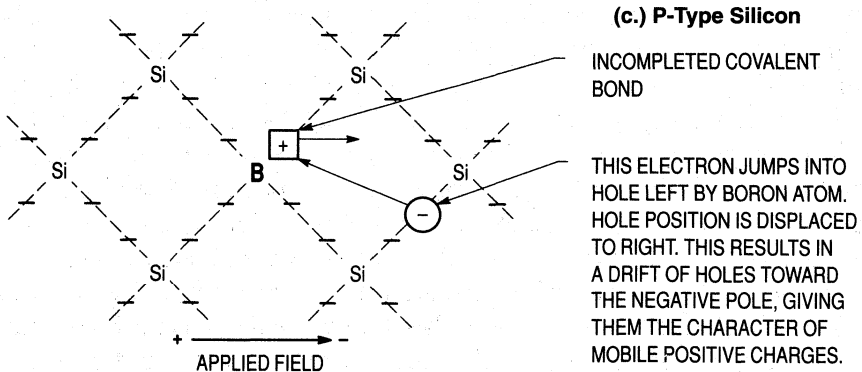
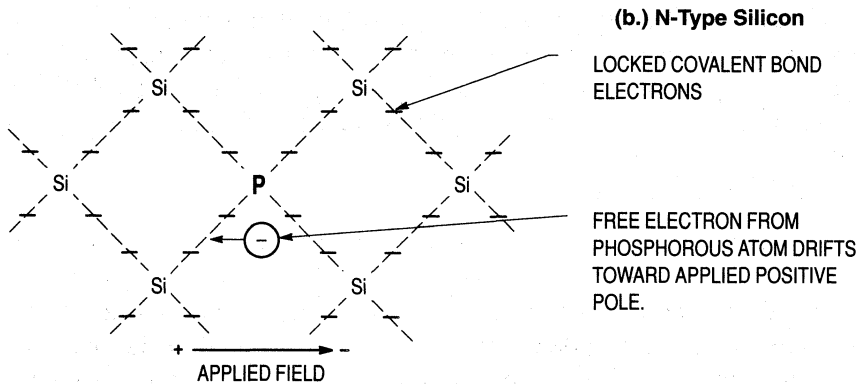
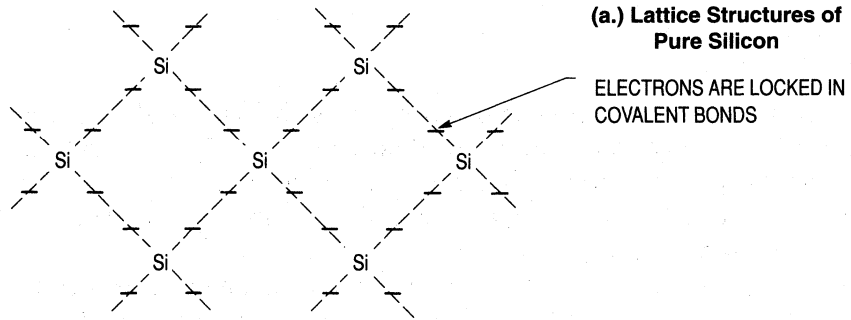

Figure 1-1. Semiconductor Structure

In P-type conductivity, the charges that carry electric current across the crystal act as if they were positive charges. We know that electricity is always carried by drifting electrons in any material, and that there are no mobile positively charged carriers in a solid. Positive charge carriers can exist in gases and liquids in the form of positive ions but not in solids. The positive character of the current flow in the semiconductor crystal may be thought of as the movement of vacancies (called holes) in the covalent lattice. These holes drift from positive toward negative in an electric field, behaving as if they were positive carriers.

P-type conductivity in semiconductors result from adding acceptor impurities (Group III elements) such as boron to silicon to the semiconductor crystal. In this case, boron atoms, with three valence electrons, enter the tetravalent silicon lattice. Since the covalent bonds cannot be satisfied by only three electrons, each acceptor atom leaves a hole in the lattice which is deficient by one electron. These holes readily accept electrons introduced by external sources or created by radiation or heat, as shown in Figure 1-1c. Hence the name acceptor ion or acceptor impurity. When an external circuit is connected, electrons from the current source “fill up” these holes from the negative end and jump from hole to hole across the crystal or one may think of this process in a slightly different but equivalent way, that is as the displacement of positive holes toward the negative terminal. It is this drift of the positively charged holes which accounts for the term P-type conductivity.

When semiconductor regions of N- and P-type conductivities are formed in a semiconductor crystal adjacent to each other, this structure is called a PN junction. Such a junction is responsible for the action of both zener diodes and rectifier devices, and will be discussed in the next section.

The Semiconductor Diode

In the forward-biased PN junction, Figure 1-2a, the P region is made more positive than the N region by an external circuit. Under these conditions there is a very low resistance to current flow in the circuit. This is because the holes in the positive P-type material are very readily attracted across the junction interface toward the negative N-type side. Conversely, electrons in the N-type are readily attracted by the positive polarity in the other direction.

When a PN junction is reverse biased, the P-type side is made more negative than the N-type side. (See Figure 1-2b.) At voltages below the breakdown of the junction, there is very little current flow across the junction interface. At first thought one would expect no reverse current under reverse bias conditions, but several effects are responsible for this small current.

Under this condition the positive holes in the P-type semiconductor are repelled from the junction interface by the positive polarity applied to the N side, and conversely, the electrons in the N material are repelled from the interface by the negative polarity of the P side. This creates a region extending from the junction interface into both P- and N-type materials which is completely free of charge carriers, that is, the region is depleted of its charge carriers. Hence, this region is usually called the depletion region.

Although the region is free of charge *carriers*, the P-side of the depletion region will have an excess negative charge due to the presence of acceptor ions which are, of course, fixed in the lattice; while the N-side of the depletion region has an excess positive charge due to

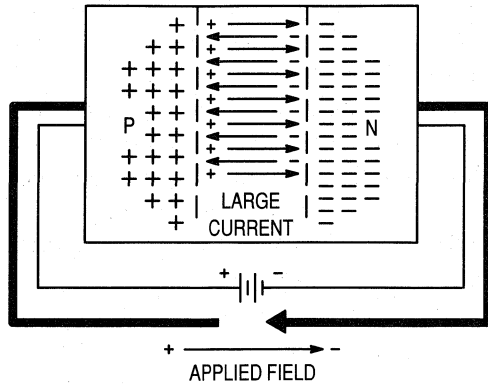

(a.) Forward-Biased PN Junction

CHARGES FROM BOTH P AND N REGIONS DRIFT ACROSS JUNCTION AT VERY LOW APPLIED VOLTAGES.

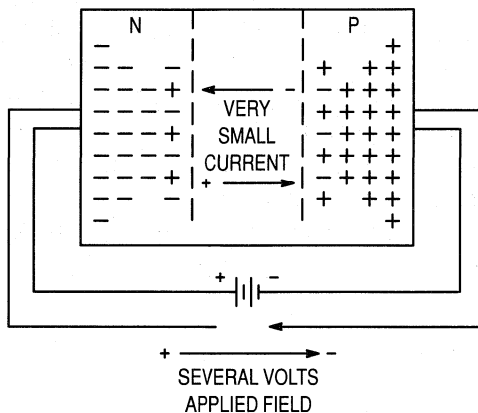

(b.) Reverse-Biased PN Junction

AT APPLIED VOLTAGES BELOW THE CRITICAL BREAKDOWN LEVEL ONLY A FEW CHARGES DRIFT ACROSS THE INTERFACE.

Figure 1-2. Effects of Junction Bias

the presence of donor ions. These opposing regions of charged ions create a strong electric field across the PN junction responsible for the creation of reverse current.

6

The semiconductor regions are never perfect; there are always a few free electrons in P material and few holes in N material. A more significant factor, however, is the fact that great magnitudes of electron-hole pairs may be thermally generated at room temperatures in the semiconductor. When these electron-hole pairs are created within the depletion region, then the intense electric field mentioned in the above paragraph will cause a small current to flow. This small current is called the reverse saturation current, and tends to maintain a relatively constant value for a fixed temperature at all voltages. The reverse saturation current is usually negligible compared with the current flow when the junction is forward biased. Hence, we see that the PN junction, when not reverse biased beyond breakdown voltage, will conduct heavily in only one direction. When this property is utilized in a circuit we are employing the PN junction as a rectifier. Let us see how we can employ its reverse breakdown characteristics to an advantage.

As the reverse voltage is increased to a point called the voltage breakdown point and beyond, current conduction across the junction interface increases rapidly. The break from

a low value of the reverse saturation current to heavy conductance is very sharp and well defined in most PN junctions. It is called the zener knee. When reverse voltages greater than the voltage breakdown point are applied to the PN junction, the voltage drop across the PN junction remains essentially constant at the value of the breakdown voltage for a relatively wide range of currents. This region beyond the voltage breakdown point is called the zener control region.

Zener Control Region: Voltage Breakdown Mechanisms

Figure 1-3 depicts the extension of reverse biasing to the point where voltage breakdown occurs. Although all PN junctions exhibit a voltage breakdown, it is important to know that there are two distinct voltage breakdown mechanisms. One is called *zener breakdown* and the other is called *avalanche breakdown*. In zener breakdown the value of breakdown voltage decreases as the PN junction temperature increases; while in avalanche breakdown the value of the breakdown voltage increases as the PN junction temperature increases. Typical diode breakdown characteristics of each category are shown in Figure 1-4. The factor determining which of the two breakdown mechanisms occurs is the relative concentrations of the impurities in the materials which comprise the junction. If two different resistivity P-type materials are placed against two separate but equally doped low-resistivity

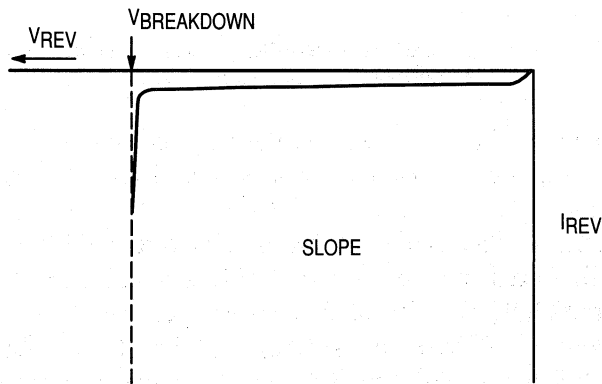

Figure 1-3. Reverse Characteristic Extended to Show Breakdown Effect

pieces of N-type materials, the depletion region spread in the low resistivity P-type material will be smaller than the depletion region spread in the high resistivity P-type material. Moreover, in both situations little of the resultant depletion width lies in the N material if its resistivity is low compared to the P-type material. In other words, the depletion region always spreads principally into the material having the highest resistivity. Also, the electric field (voltage per unit length) in the less resistive material is greater than the electric field in the material of greater resistivity due to the presence of more ions/unit volume in the less

resistive material. A junction that results in a narrow depletion region will therefore develop a high field intensity and breakdown by the zener mechanism. A junction that results in a wider depletion region and, thus, a lower field intensity will break down by the avalanche mechanism before a zener breakdown condition can be reached.

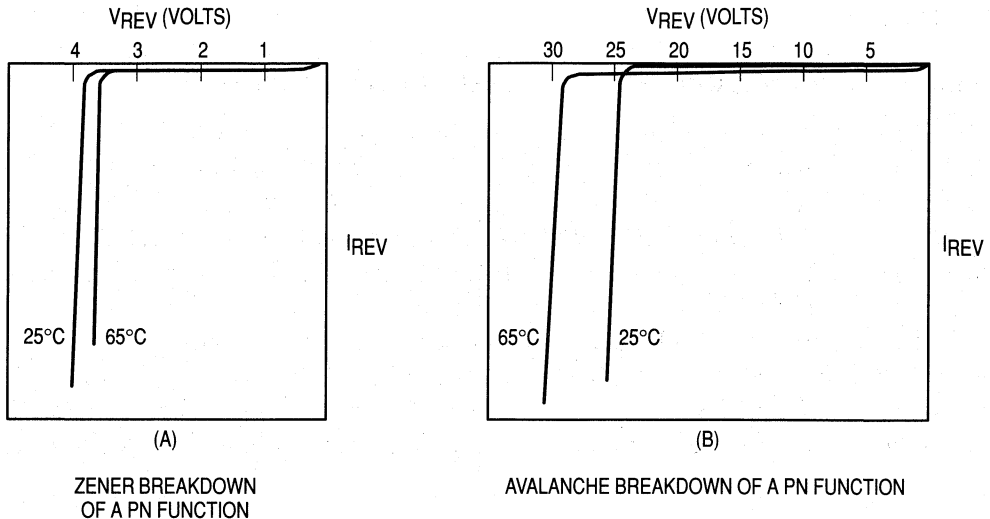

Figure 1-4. Typical Breakdown Diode Characteristics. Note Effects of Temperature for Each Mechanism

The zener mechanism can be described qualitatively as follows: because the depletion width is very small, the application of low reverse bias (5 volts or less) will cause a field across the depletion region on the order of $3 \times 10^5 \text{V/cm}$. A field of such high magnitude exerts a large force on the valence electrons of a silicon atom, tending to separate them from their respective nuclei. Actual rupture of the covalent bonds occurs when the field approaches $3 \times 10^5 \text{V/cm}$. Thus, electron-hole pairs are generated in large numbers and a sudden increase of current is observed. Although we speak of a rupture of the atomic structure, it should be understood that this generation of electron-hole pairs may be carried on continuously as long as an external source supplies additional electrons. If a limiting resistance in the circuit external to the diode junction does not prevent the current from increasing to high values, the device may be destroyed due to overheating. The actual critical value of field causing zener breakdown is believed to be approximately $3 \times 10^5 \text{V/cm}$. On most commercially available silicon diodes, the maximum value of voltage breakdown by the zener mechanism is 8 volts. In order to fabricate devices with higher voltage breakdown characteristics, materials with higher resistivity, and consequently, wider depletion regions are required. These wide depletion regions hold the field strength down below the zener breakdown value ($3 \times 10^5 \text{V/cm}$). Consequently, for devices with breakdown voltage lower than 5 volts the zener mechanism predominates, between 5 and 8 volts both zener and an

avalanche mechanism are involved, while above 8 volts the avalanche mechanism alone takes over.

The decrease of zener breakdown voltage as junction temperature increases can be explained in terms of the energies of the valence electrons. An increase of temperature increases the energies of the valence electrons. This weakens the bonds holding the electrons and consequently, less applied voltage is necessary to pull the valence electrons from their position around the nuclei. Thus, the breakdown voltage decreases as the temperature increases.

The dependence on temperature of the avalanche breakdown mechanism is quite different. Here the depletion region is of sufficient width that the carriers (electrons or holes) can suffer collisions before traveling the region completely i.e., the depletion region is wider than one mean-free path (the average distance a carrier can travel before combining with a carrier of opposite conductivity). Therefore, when temperature is increased, the increased lattice vibration shortens the distance a carrier travels before colliding and thus requires a higher voltage to get it across the depletion region.

As established earlier, the applied reverse bias causes a small movement of intrinsic electrons from the P material to the potentially positive N material and intrinsic holes from the N material to the potentially negative P material (leakage current). As the applied voltage becomes larger, these electrons and holes increasingly accelerate. There are also collisions between these intrinsic particles and bound electrons as the intrinsic particles move through the depletion region. If the applied voltage is such that the intrinsic electrons do not have high velocity, then the collisions take some energy from the intrinsic particles, altering their velocity. If the applied voltage is increased, collision with a valence electron will give considerable energy to the electron and it will break free of its covalent bond. Thus, one electron by collision, has created an electron-hole pair. These secondary particles will also be accelerated and participate in collisions which generate new electron-hole pairs. This phenomenon is called carrier multiplication. Electron-hole pairs are generated so quickly and in such large numbers that there is an apparent avalanche or self-sustained multiplication process (depicted graphically in Figure 1-5). The junction is said to be in breakdown and the current is limited only by resistance external to the junction. Zener diodes above 7 to 8 volts exhibit avalanche breakdown.

As junction temperature increases, the voltage breakdown point for the avalanche mechanism increases. This effect can be explained by considering the vibration displacement of atoms in their lattice increases, and this increased displacement corresponds to an increase in the probability that intrinsic particles in the depletion region will collide with the lattice atoms. If the probability of an intrinsic particle-atom collision increases, then the probability that a given intrinsic particle will obtain high momentum decreases, and it follows that the low momentum intrinsic particles are less likely to ionize the lattice atoms. Naturally, increased voltage increases the acceleration of the intrinsic particles, providing higher mean momentum and more electron-hole pairs production. If the voltage is raised sufficiently, the mean momentum becomes great enough to create electron-hole pairs and carrier multiplication results. Hence, for increasing temperature, the value of the avalanche breakdown voltage increases.

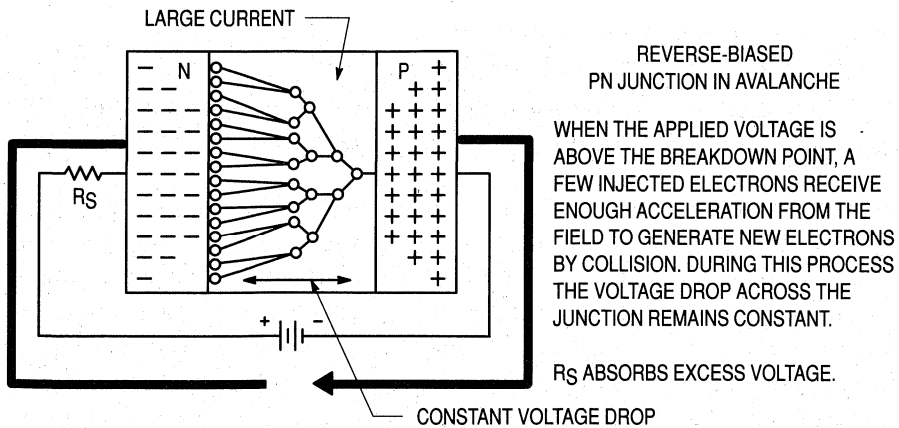

Figure 1-5. PN Junction in Avalanche Breakdown

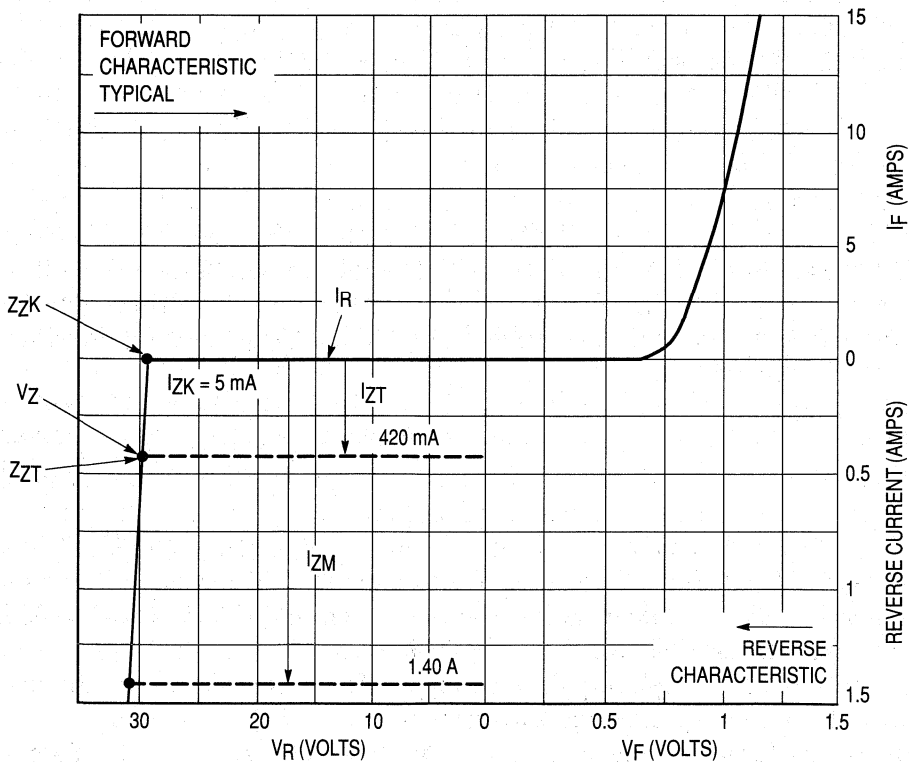

Figure 1-6. Zener Diode Characteristics

6

Volt-Ampere Characteristics

The zener volt-ampere characteristics for a typical 30 volt zener diode is illustrated in Figure 1-6. It shows that the zener diode conducts current in both directions; the forward current I_F being a function of forward voltage V_F . Note that I_F is small until $V_F \approx 0.65$ V; then I_F increases very rapidly. For $V_F > 0.65$ V I_F is limited primarily by the circuit resistance external to the diode.

The reverse current is a function of the reverse voltage V_R but for most practical purposes is zero until the reverse voltage approaches V_Z , the PN junction breakdown voltage, at which time the reverse current increases very rapidly. Since the reverse current is small for $V_R < V_Z$, but great for $V_R > V_Z$ each of the current regions is specified by a different symbol. For the leakage current region, i.e. non-conducting region, between 0 volts and V_Z , the reverse current is denoted by the symbol I_R ; but for the zener control region, $V_R \geq V_Z$, the reverse current is denoted by the symbol I_Z . I_R is usually specified at a reverse voltage $V_R \approx 0.8 V_Z$.

The PN junction breakdown voltage, V_Z , is usually called the zener voltage, regardless whether the diode is of the zener or avalanche breakdown type. Commercial zener diodes are available with zener voltages from about 1.8 V – 400 V. For most applications the zener diode is operated well into the breakdown region (I_{ZT} to I_{ZM}). Most manufacturers give an additional specification of I_{ZK} (= 5 mA in Figure 1-6) to indicate a minimum operating current to assure reasonable regulation.

This minimum current I_{ZK} varies in the various types of zener diodes and, consequently, is given on the data sheets. The maximum zener current I_{ZM} should be considered the maximum reverse current recommended by the manufacturer. Values of I_{ZM} are usually given in the data sheets.

Between the limits of I_{ZK} and I_{ZM} , which are 5 mA and 1400 mA (1.4 Amps) in the example of Figure 1-6, the voltage across the diode is essentially constant, and $\approx V_Z$. This plateau region has, however, a large positive slope such that the precise value of reverse voltage will change slightly as a function of I_Z . For any point on this plateau region one may calculate an impedance using the incremental magnitudes of the voltage and current. This impedance is usually called the zener impedance Z_Z , and is specified for most zener diodes. Most manufacturers measure the maximum zener impedance at two test points on the plateau region. The first is usually near the knee of the zener plateau, Z_{ZK} , and the latter point near the midrange of the usable zener current excursion. Two such points are illustrated in Figure 1-6.

This section was intended to introduce the reader to a few of the major terms used with zener diodes. A complete description of these terms may be found in chapter four. In chapter four a full discussion of zener leakage, DC breakdown, zener impedance, temperature coefficients and many other topics may be found.

CHAPTER 2: ZENER DIODE FABRICATION TECHNIQUES

Introduction

A brief exposure to the techniques used in the fabrication of zener diodes can provide the engineer with additional insight using zeners in their applications. That is, an understanding of zener fabrication makes the capabilities and limitations of the zener diode more meaningful. This chapter discusses the basic steps in the fabrication of the zener from crystal growing through final testing.

Zener Diode Wafer Fabrication

The major steps in the manufacture of zeners are provided in the process flow in Figure 2-1. It is important to point out that the manufacturing steps vary somewhat from manufacturer to manufacturer, and also vary with the type of zener diode produced. This is driven by the type of package required as well as the electrical characteristics desired. For example, alloy diffused devices provide excellent low voltage reference with low leakage characteristics but do not have the same surge carrying capability as diffused diodes. The manufacturing process begins with the growing of high quality silicon crystals.

Crystals for Motorola zener diodes are grown using the Czochralski technique, a widely used process which begins with ultra-pure polycrystalline silicon. The polycrystalline silicon is first melted in a nonreactive crucible held at a temperature just above the melting point. A carefully controlled quantity of the desired dopant impurity, such as phosphorus or boron is added. A high quality seed crystal of the desired crystalline orientation is then lowered into the melt while rotating. A portion of this seed crystal is allowed to melt into the molten silicon. The seed is then slowly pulled and continues to rotate as it is raised from the melt. As the seed is raised, cooling takes place and material from the melt adheres to it, thus forming a single crystal ingot. With this technique, ingots with diameters of several inches can be fabricated.

Once the single-crystal silicon ingot is grown, it is tested for doping concentration (resistivity), undesired impurity levels, and minority carrier lifetime. The ingot is then sliced into thin, circular wafers. The wafers are then chemically etched to remove saw damage and polished in a sequence of successively finer polishing grits until a mirror-like defect free surface is obtained. The wafers are then cleaned and placed in vacuum sealed wafer carriers to prevent any contamination from getting on them. At this point, the wafers are ready to begin device fabrication.

Zener diodes can be manufactured using different processing techniques such as planar processing or mesa etched processing. The majority of Motorola zener diodes are manufactured using the planar technique as shown in Figure 2-2.

The planar process begins by growing an ultra-clean protective silicon dioxide passivation layer. The oxide is typically grown in the temperature range of 900 to 1200 degrees celcius.

Once the protective layer of silicon dioxide has been formed, it must be selectively removed from those areas into which dopant atoms will be introduced. This is done using photolithographic techniques.

First a light sensitive solution called photo resist is spun onto the wafer. The resist is then dried and a photographic negative or mask is placed over the wafer. The resist is then exposed to ultraviolet light causing the molecules in it to cross link or polymerize becoming very rigid. Those areas of the wafer that are protected by opaque portions of the mask are not exposed and are developed away. The oxide is then etched forming the exposed regions in which the dopant will be introduced. The remaining resist is then removed and the wafers carefully cleaned for the doping steps.

Dopant is then introduced onto the wafer surface using various techniques such as aluminum alloy for low voltage devices, ion-implantation, spin-on dopants, or chemical vapor deposition. Once the dopant is deposited, the junctions are formed in a subsequent high temperature (1100 to 1250 degrees celcius are typical) drive-in. The resultant junction profile is determined by the background concentration of the starting substrate, the amount of dopant placed at the surface, and amount of time and temperature used during the dopant drive-in. This junction profile determines the electrical characteristics of the device. During the drive-in cycle, additional passivation oxide is grown providing additional protection for the devices.

After junction formation, the wafers are then processed through what is called a getter process. The getter step utilizes high temperature and slight stress provided by a highly doped phosphosilicate glass layer introduced into the backside of the wafers. This causes any contaminants in the area of the junction to diffuse away from the region. This serves to improve the reverse leakage characteristic and the stability of the device. Following the getter process, a second photo resist step opens the contact area in which the anode metallization is deposited.

Metal systems for Motorola's zener diodes are determined by the requirements of the package. The metal systems are deposited in ultra-clean vacuum chambers utilizing electron-beam evaporation techniques. Once the metal is deposited, photo resist processing is utilized to form the desired patterns. The wafers are then lapped to their final thickness and the cathode metallization deposited using the same e-beam process.

The quality of the wafers is closely monitored throughout the process by using statistical process control techniques and careful microscopic inspections at critical steps. Special wafer handling equipment is used throughout the manufacturing process to minimize contamination and to avoid damaging the wafers in any way. This further enhances the quality and stability of the devices.

Upon completion of the fabrication steps, the wafers are electrically probed, inspected, and packaged for shipment to the assembly operations. All Motorola zener diode product is sawn using 100% saw-through techniques stringently developed to provide high quality silicon die.

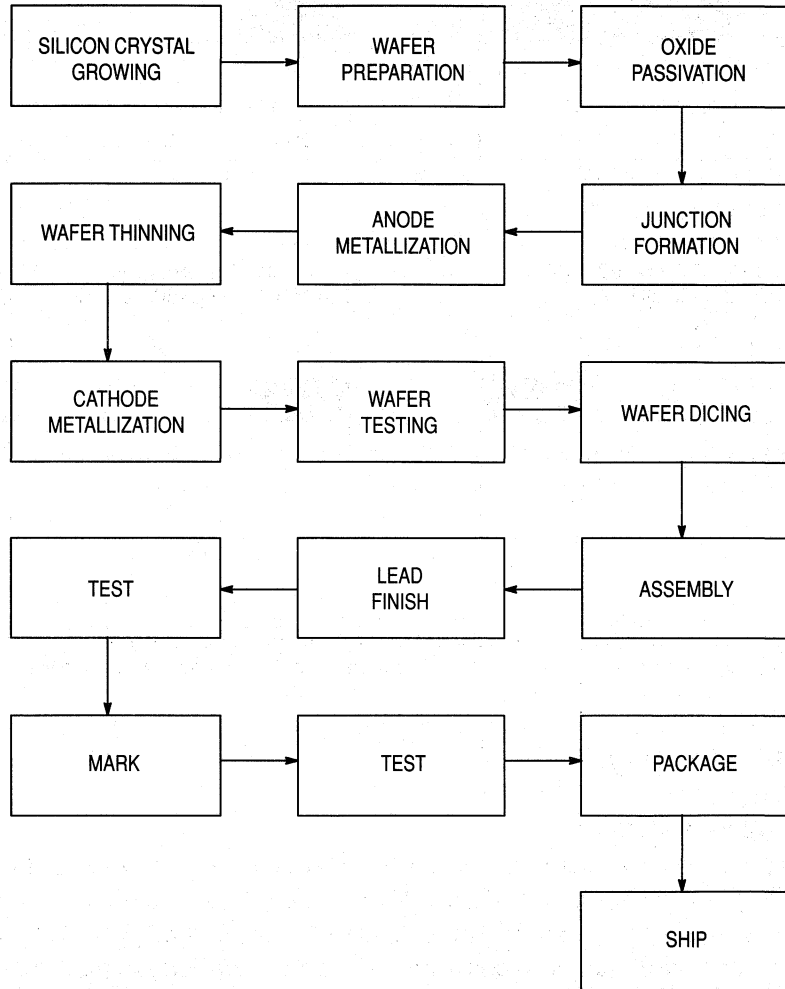

Figure 2-1. General Flow of the Zener Diode Process

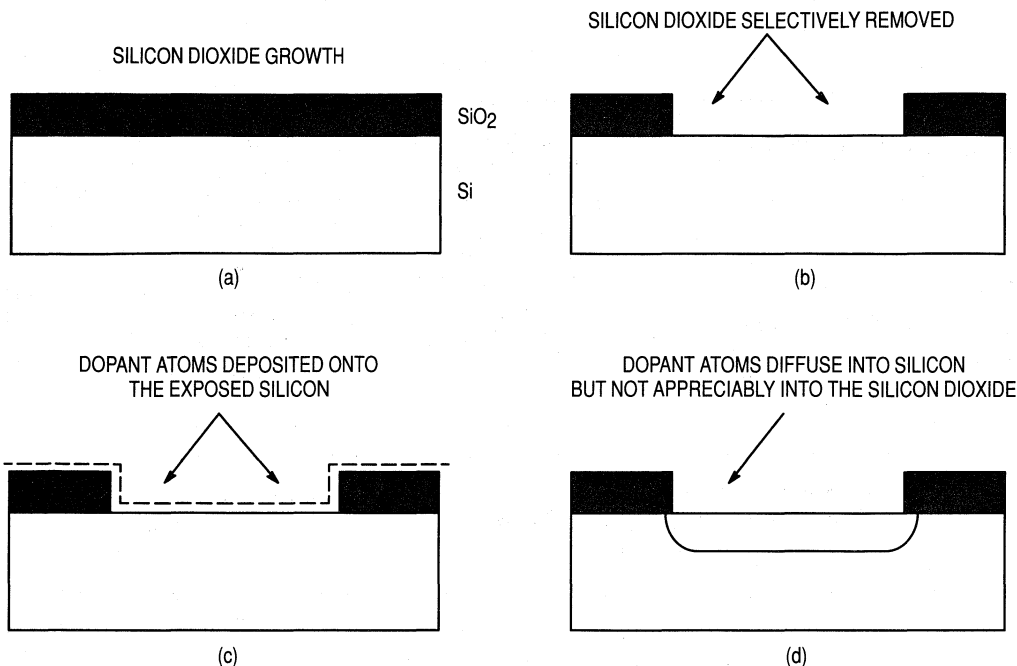

Figure 2-2. Basic Fabrication Steps in the Silicon Planar Process: a) oxide formation, b) selective oxide removal, c) deposition of dopant atoms, d) junction formation by diffusion of dopant atoms.

Zener Diode Assembly

Surmetic 30, 40 and MOSORB

The plastic packages (Surmetic 30, 40 and MOSORBs) are assembled using oxygen free high conductivity copper leads for efficient heat transfer from the die and allowing maximum power dissipation with a minimum of external heatsinking. Figure 2-3 shows typical assembly. The leads are of nail head construction, soldered directly to the die, which further enhances the heat dissipating capabilities of the package.

The Surmetic 30s, 40s and MOSORBs are basically assembled in the same manner; the only difference being the MOSORBs are soldered together using a solder disc between the lead and die whereas the Surmetic 30s and Surmetic 40s utilize pre-soldered leads.

Assembly is started on the Surmetic 30 and 40 by loading the leads into assembly boats and pre-soldering the nail heads. After pre-soldering, one die is then placed into each cavity of one assembly boat and another assembly boat is then mated to it. Since the MOSORBs do not use pre-soldered leads, the leads are put into the assembly boat, a solder disc is placed into each cavity and then a die is put in on top. A solder disc is put in on top of the die. Another assembly boat containing only leads is mated to the boat containing the leads, die, and two

solder discs. The boats are passed through the assembly furnace; this operation requires only one pass through the furnace.

After assembly, the leads on the Surmetic 30s, 40s and MOSORBs are plated with a tin-lead alloy making them readily solderable and corrosion resistant.

Double Slug (DO-35 and DO-41)

Double slugs receive their name from the dumet slugs, one attached to one end of each lead. These slugs sandwich the pre-tinned die between them and are hermetically sealed to the glass envelope or body during assembly. Figure 2-4 shows typical assembly.

The assembly begins with the copper clad steel leads being loaded into assembly "boats." Every other boat load of leads has a glass body set over the slug. A pre-tinned die is placed into each glass body and the other boat load of leads is mated to the boat holding the leads, body and die. These mated boats are then placed into the assembly furnace where the total mass is heated. Each glass body melts; and as the boat proceeds through the cooling portion of the furnace chamber, the tin which has wetted to each slug solidifies forming a bond between the die and both slugs. The glass hardens, attaching itself to the sides of the two slugs forming the hermetic seal. The above illustrates how the diodes are completely assembled using a single furnace pass minimizing assembly problems.

The encapsulated devices are then processed through lead finish. This consists of dipping the leads in molten tin/lead solder alloy. The solder dipped leads produce an external finish which is tarnish-resistant and very solderable.

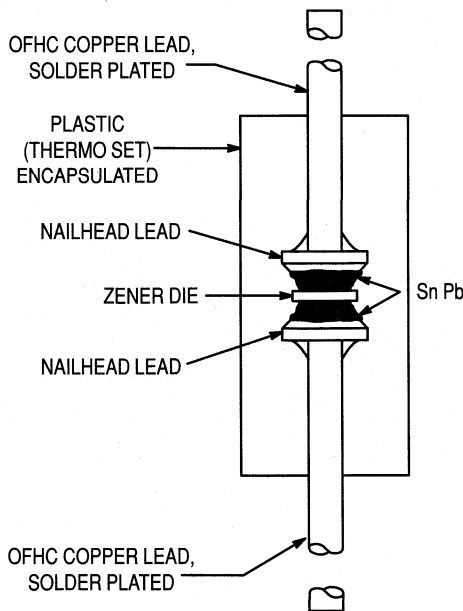

Figure 2-3. Double-Slug Plastic Zener Construction

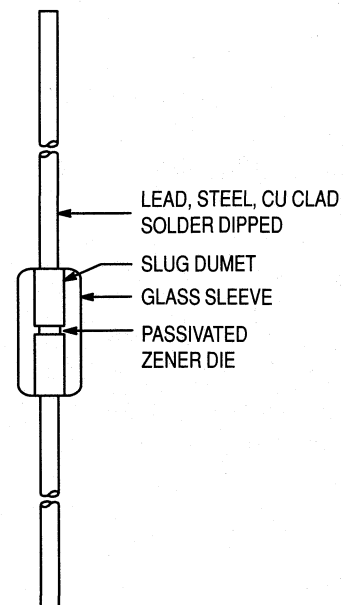

Figure 2-4. Double Slug Glass Zener Construction

Zener Diode Test, Mark and Packaging

Double Slug, Surmetic 30, 40 and MOSORB

After lead finish, all products are final tested, whether they are double slug or of Surmetic construction, all are 100 percent final tested for zener voltage, leakage current, impedance and forward voltage drop.

Process average testing is used which is based upon the averages of the previous lots for a given voltage line and package type. Histograms are generated for the various parameters as the units are being tested to ensure that the lot is testing well to the process average and compared against other lots of the same voltage.

After testing, the units are marked as required by the specification. The markers are equipped to polarity orient the devices as well as perform 100% redundant test prior to packaging.

After marking, the units are packaged either in "bulk" form or taped and reeled or taped and ammo packed to accommodate automatic insertion.

CHAPTER 3: RELIABILITY

Introduction

Motorola's Quality System maintains "continuous product improvement" goals in all phases of the operation. Statistical process control (SPC), quality control sampling, reliability audits and accelerated stress testing techniques monitor the quality and reliability of its products. Management and engineering skills are continuously upgraded through training programs. This maintains a unified focus on Six Sigma quality and reliability from the inception of the product to final customer use.

Statistical Process Control

Motorola's Discrete Group is continually pursuing new ways to improve product quality. Initial design improvement is one method that can be used to produce a superior product. Equally important to outgoing product quality is the ability to produce product that consistently conforms to specification. Process variability is the basic enemy of semiconductor manufacturing since it leads to product variability. Used in all phases of Motorola's product manufacturing, STATISTICAL PROCESS CONTROL (SPC) replaces variability with predictability. The traditional philosophy in the semiconductor industry has been adherence to the data sheet specification. Using SPC methods assures the product will meet specific process requirements throughout the manufacturing cycle. The emphasis is on defect prevention, not detection. Predictability through SPC methods requires the manufacturing culture to focus on constant and permanent improvements. Usually these improvements cannot be bought with state-of-the-art equipment or automated factories. With quality in design, process and material selection, coupled with manufacturing predictability, Motorola can produce world class products.

The immediate effect of SPC manufacturing is predictability through process controls. Product centered and distributed well within the product specification benefits Motorola with fewer rejects, improved yields and lower cost. The direct benefit to Motorola's customers includes better incoming quality levels, less inspection time and ship-to-stock capability. Circuit performance is often dependent on the cumulative effect of component variability. Tightly controlled component distributions give the customer greater circuit predictability. Many customers are also converting to just-in-time (JIT) delivery programs. These programs require improvements in cycle time and yield predictability achievable only through SPC techniques. The benefit derived from SPC helps the manufacturer meet the customer's expectations of higher quality and lower cost product.

Ultimately, Motorola will have Six Sigma capability on all products. This means parametric distributions will be centered within the specification limits with a product distribution of plus or minus Six Sigma about mean. Six Sigma capability, shown graphically in

Figure 3-1, details the benefit in terms of yield and outgoing quality levels. This compares a centered distribution versus a 1.5 sigma worst case distribution shift.

New product development at Motorola requires more robust design features that make them less sensitive to minor variations in processing. These features make the implementation of SPC much easier.

A complete commitment to SPC is present throughout Motorola. All managers, engineers, production operators, supervisors and maintenance personnel have received multiple training courses on SPC techniques. Manufacturing has identified 22 wafer processing and 8 assembly steps considered critical to the processing of zener products. Processes, controlled by SPC methods, that have shown significant improvement are in the diffusion, photolithography and metallization areas.

To better understand SPC principles, brief explanations have been provided. These cover process capability, implementation and use.

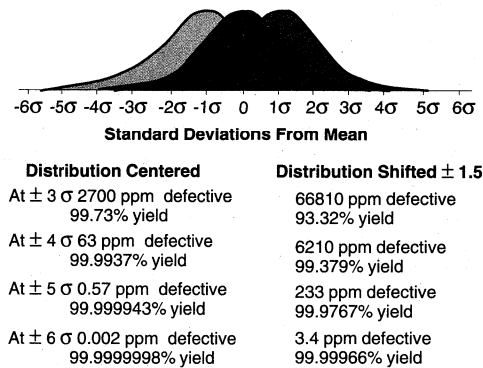

Figure 3-1. AOQL and Yield from a Normal Distribution of Product With 6σ Capability

PROCESS CAPABILITY

One goal of SPC is to ensure a process is **CAPABLE**. Process capability is the measurement of a process to produce products consistently to specification requirements. The purpose of a process capability study is to separate the inherent **RANDOM VARIABILITY** from **ASSIGNABLE CAUSES**. Once completed, steps are taken to identify and eliminate the most significant assignable causes. Random variability is generally present in the system and does not fluctuate. Sometimes, these are considered basic limitations associated with the machinery, materials, personnel skills or manufacturing methods. Assignable cause inconsistencies relate to time variations in yield, performance or reliability.

Traditionally, assignable causes appear to be random due to the lack of close examination or analysis. Figure 3-2 shows the impact on predictability that assignable cause can have. Figure 3-3 shows the difference between process control and process capability.

A process capability study involves taking periodic samples from the process under controlled conditions. The performance characteristics of these samples are charted against time. In time, assignable causes can be identified and engineered out. Careful documentation

of the process is key to accurate diagnosis and successful removal of the assignable causes. Sometimes, the assignable causes will remain unclear requiring prolonged experimentation.

Elements which measure process variation control and capability are Cp and Cpk respectively. Cp is the specification width divided by the process width or $Cp = (\text{specification width}) / 6\sigma$. Cpk is the absolute value of the closest specification value to the mean, minus the mean, divided by half the process width or $Cpk = |\text{closest specification} - \bar{X}| / 3\sigma$.

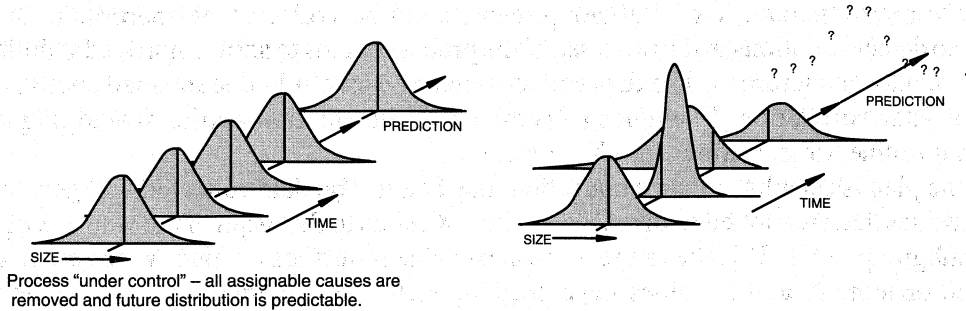

Figure 3-2. Impact of Assignable Causes on Process Predictable

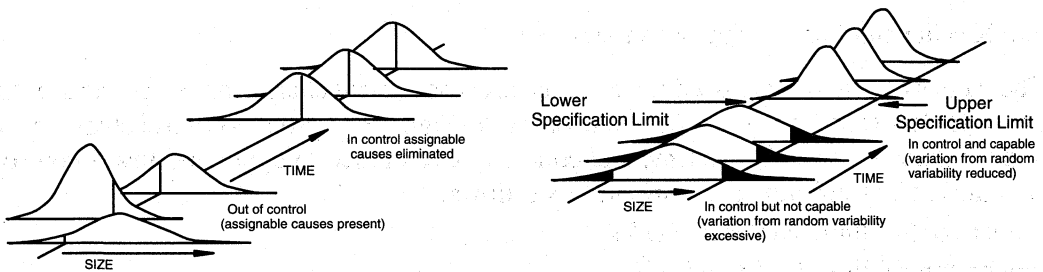

Figure 3-3. Difference Between Process Control and Process Capability

At Motorola, for critical parameters, the process capability is acceptable with a $Cpk = 1.33$. The desired process capability is a $Cpk = 2$ and the ideal is a $Cpk = 5$. Cpk , by definition, shows where the current production process fits with relationship to the specification limits. Off center distributions or excessive process variability will result in less than optimum conditions.

SPC IMPLEMENTATION AND USE

The Discrete Group uses many parameters that show conformance to specification. Some parameters are sensitive to process variations while others remain constant for a given product line. Often, specific parameters are influenced when changes to other parameters occur. It is both impractical and unnecessary to monitor all parameters using SPC methods. Only critical parameters that are sensitive to process variability are chosen for SPC monitoring. The process steps affecting these critical parameters must be identified also. It is equally

important to find a measurement in these process steps that correlates with product performance. This is called a critical process parameter.

Once the critical process parameters are selected, a sample plan must be determined. The samples used for measurement are organized into **RATIONAL SUBGROUPS** of approximately 2 to 5 pieces. The subgroup size should be such that variation among the samples within the subgroup remain small. All samples must come from the same source e.g., the same mold press operator, etc.. Subgroup data should be collected at appropriate time intervals to detect variations in the process. As the process begins to show improved stability, the interval may be increased. The data collected must be carefully documented and maintained for later correlation. Examples of common documentation entries would include operator, machine, time, settings, product type, etc..

Once the plan is established, data collection may begin. The data collected will generate \bar{X} and R values that are plotted with respect to time. \bar{X} refers to the mean of the values within a given subgroup, while R is the range or greatest value minus least value. When approximately 20 or more \bar{X} and R values have been generated, the average of these values is computed as follows:

$$\bar{\bar{X}} = (\bar{X}_1 + \bar{X}_2 + \bar{X}_3 + \dots)/K$$

$$\bar{R} = (R_1 + R_2 + R_3 + \dots)/K$$

where K = the number of subgroups measured.

The values of $\bar{\bar{X}}$ and \bar{R} are used to create the process control chart. Control charts are the primary SPC tool used to signal a problem. Shown in Figure 3-4, process control charts show \bar{X} and R values with respect to time and concerning reference to upper and lower control limit values. Control limits are computed as follows:

$$R \text{ upper control limit} = UCLR = D_4 \bar{R}$$

$$R \text{ lower control limit} LCLR = D_3 \bar{R}$$

$$\bar{X} \text{ upper control limit} = UCLX = \bar{\bar{X}} + A_2 \bar{R}$$

$$\bar{X} \text{ lower control limit} = LCLX = \bar{\bar{X}} - A$$

Where D_4 , D_3 and A_2 are constants varying by sample size, with values for sample sizes from 2 to 10 shown in the following partial table:

n	2	3	4	5	6	7	8	9	10
D4	3.27	2.57	2.28	2.11	2.00	1.92	1.86	1.82	1.78
D3	*	*	*	*	*	0.08	0.14	0.18	0.22
A2	1.88	1.02	0.73	0.58	0.48	0.42	0.37	0.34	0.31

* For sample sizes below 7, the LCLR would technically be a negative number; in those cases there is no lower control limit; this means that for a subgroup size 6, six "identical" measurements would not be unreasonable.

Control charts are used to monitor the variability of critical process parameters. The R chart shows basic problems with piece to piece variability related to the process. The X chart can often identify changes in people, machines, methods, etc. The source of the variability

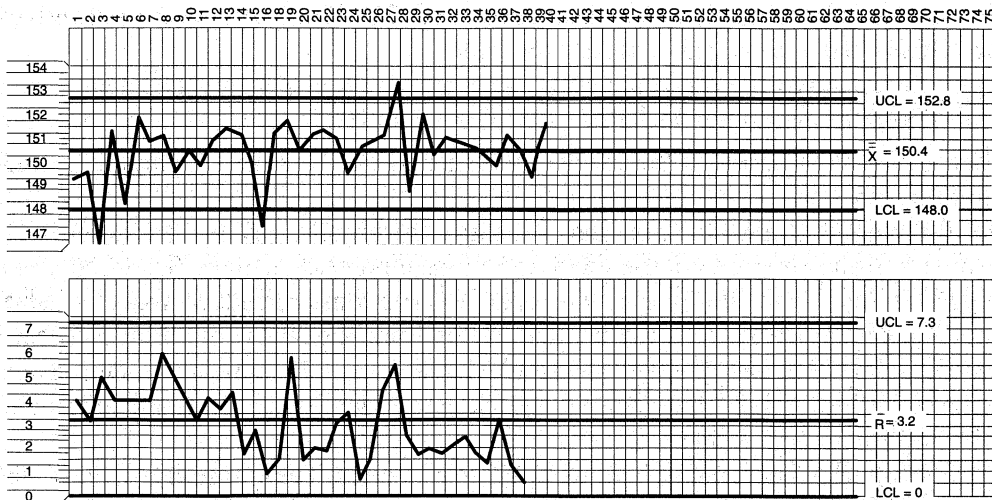

Figure 3-4. Example of Process Control Chart Showing Oven Temperature Data

can be difficult to find and may require experimental design techniques to identify assignable causes.

Some general rules have been established to help determine when a process is **OUT-OF-CONTROL**. Figure 3-5a shows a control chart subdivided into zones A, B, and C corresponding to 3 sigma, 2 sigma, and 1 sigma limits respectively. In Figure 3-5b through Figure 3-5e four of the tests that can be used to identify excessive variability and the presence of assignable causes are shown. As familiarity with a given process increases, more subtle tests may be employed successfully.

Once the variability is identified, the cause of the variability must be determined. Normally, only a few factors have a significant impact on the total variability of the process. The importance of correctly identifying these factors is stressed in the following example. Suppose a process variability depends on the variance of five factors A, B, C, D and E. Each has a variance of 5, 3, 2, 1 and 0.4 respectively.

Since:

$$\sigma_{\text{tot}} = \sqrt{\sigma_A^2 + \sigma_B^2 + \sigma_C^2 + \sigma_D^2 + \sigma_E^2}$$

$$\sigma_{\text{tot}} = \sqrt{5^2 + 3^2 + 2^2 + 1^2 + (0.4)^2} = 6.3$$

Now if only D is identified and eliminated then;

$$\sigma_{\text{tot}} = \sqrt{5^2 + 3^2 + 2^2 + (0.4)^2} = 6.2$$

This results in less than 2% total variability improvement. If B, C and D were eliminated, then;

$$\sigma_{\text{tot}} = \sqrt{5^2 + (0.4)^2} = 5.02$$

This gives a considerably better improvement of 23%. If only A is identified and reduced from 5 to 2, then;

$$\sigma_{\text{tot}} = \sqrt{2^2 + 3^2 + 2^2 + 1^2 + (0.4)^2} = 4.3$$

Identifying and improving the variability from 5 to 2 gives us a total variability improvement of nearly 40%.

Most techniques may be employed to identify the primary assignable cause(s). Out-of-control conditions may be correlated to documented process changes. The product may be analyzed in detail using best versus worst part comparisons or Product Analysis Lab equipment. Multi-variance analysis can be used to determine the family of variation (positional, critical or temporal). Lastly, experiments may be run to test theoretical or factorial analysis. Whatever method is used, assignable causes must be identified and eliminated in the most expeditious manner possible.

After assignable causes have been eliminated, new control limits are calculated to provide a more challenging variability criteria for the process. As yields and variability improve, it may become more difficult to detect improvements because they become much smaller. When all assignable causes have been eliminated and the points remain within control limits for 25 groups, the process is said to be in a state of control.

SUMMARY

Motorola is committed to the use of STATISTICAL PROCESS CONTROLS. These principles, used throughout manufacturing, have already resulted in many significant improvements to the processes. Continued dedication to the SPC culture will allow Motorola to reach the Six Sigma and zero defect capability goals. SPC will further enhance the commitment to **TOTAL CUSTOMER SATISFACTION**.

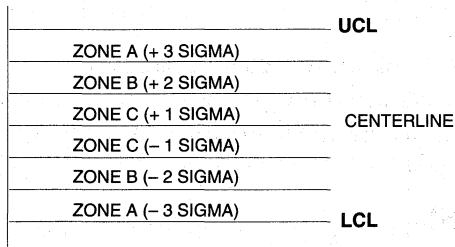

Figure 3-5a. Control Chart Zones

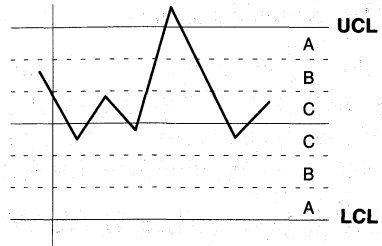

Figure 3-5b. One Point Outside Control Limit Indicating Excessive Variability

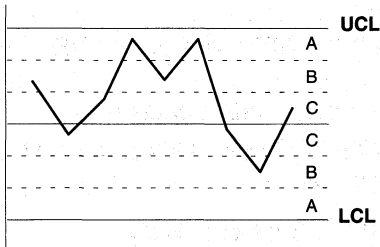

Figure 3-5c. Two Out of Three Points in Zone A or Beyond Indicating Excessive Variability

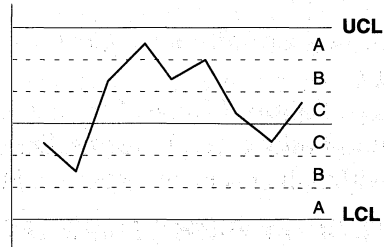

Figure 3-5d. Four Out of Five Points in Zone B or Beyond Indicating Excessive Variability

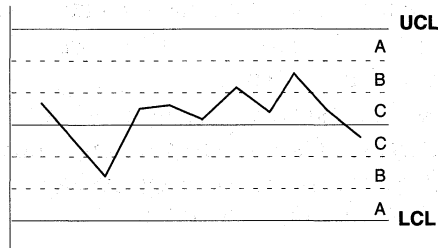

Figure 3-5e. Seven Out of Eight Points in Zone C or Beyond Indicating Excessive Variability

Reliability Stress Tests

The following gives brief descriptions of the reliability tests commonly used in the reliability monitoring program. Not all of the tests listed are performed on each product. Other tests may be performed when appropriate. In addition some form of preconditioning may be used in conjunction with the following tests.

AUTOCLAVE (aka, PRESSURE COOKER)

Autoclave is an environmental test which measures device resistance to moisture penetration and the resultant effects of galvanic corrosion. Autoclave is a highly accelerated and destructive test.

Typical Test Conditions: $T_A = 121^\circ\text{C}$, $\text{rh} = 100\%$, $p = 1$ atmosphere (15 psig), $t = 24$ to 96 hours

Common Failure Modes: Parametric shifts, high leakage and/or catastrophic

Common Failure Mechanisms: Die corrosion or contaminants such as foreign material on or within the package materials. Poor package sealing

HIGH HUMIDITY HIGH TEMPERATURE BIAS (H3TB or H3TRB)

This is an environmental test designed to measure the moisture resistance of plastic encapsulated devices. A bias is applied to create an electrolytic cell necessary to accelerate corrosion of the die metallization. With time, this is a catastrophically destructive test.

Typical Test Conditions: $T_A = 85^\circ\text{C}$ to 95°C , $\text{rh} = 85\%$ to 95% , Bias = 80% to 100% of Data Book max. rating, $t = 96$ to 1750 hours

Common Failure Modes: Parametric shifts, high leakage and/or catastrophic

Common Failure Mechanisms: Die corrosion or contaminants such as foreign material on or within the package materials. Poor package sealing

Military Reference: MIL-STD-750, Method 1042

HIGH TEMPERATURE REVERSE BIAS (HTRB)

The purpose of this test is to align mobile ions by means of temperature and voltage stress to form a high-current leakage path between two or more junctions.

Typical Test Conditions: $T_A = 85^\circ\text{C}$ to 150°C , Bias = 80% to 100% of Data Book max. rating, $t = 120$ to 1000 hours

Common Failure Modes: Parametric shifts in leakage

Common Failure Mechanisms: Ionic contamination on the surface or under the metallization of the die

Military Reference: MIL-STD-750, Method 1039

HIGH TEMPERATURE STORAGE LIFE (HTSL)

High temperature storage life testing is performed to accelerate failure mechanisms which are thermally activated through the application of extreme temperatures.

Typical Test Conditions: $T_A = 70^\circ\text{C}$ to 200°C , no bias, $t = 24$ to 2500 hours

Common Failure Modes: Parametric shifts in leakage

Common Failure Mechanisms: Bulk die and diffusion defects

Military Reference: MIL-STD-750, Method 1032

INTERMITTENT OPERATING LIFE (IOL)

The purpose of this test is the same as SSOL in addition to checking the integrity of both wire and die bonds by means of thermal stressing.

Typical Test Conditions: $T_A = 25^\circ\text{C}$, $P_d = \text{Data Book maximum rating}$, $T_{\text{On}} = T_{\text{Off}} = \Delta$ of 50°C to 100°C , $t = 42$ to 30000 cycles

Common Failure Modes: Parametric shifts and catastrophic

Common Failure Mechanisms: Foreign material, crack and bulk die defects, metallization, wire and die bond defects

Military Reference: MIL-STD-750, Method 1037

MECHANICAL SHOCK

This test is used to determine the ability of the device to withstand a sudden change in mechanical stress due to abrupt changes in motion as seen in handling, transportation, or actual use.

Typical Test Conditions: Acceleration = 1500 g's, Orientation = X_1, Y_1, Y_2 plane, $t = 0.5$ msec, Blows = 5

Common Failure Modes: Open, short, excessive leakage, mechanical failure

Common Failure Mechanisms: Die and wire bonds, cracked die, package defects

Military Reference: MIL-STD-750, Method 2015

MOISTURE RESISTANCE

The purpose of this test is to evaluate the moisture resistance of components under temperature/humidity conditions typical of tropical environments.

Typical Test Conditions: $T_A = -10^\circ\text{C}$ to 65°C , $\text{rh} = 80\%$ to 98% , $t = 24$ hours/cycle, cycle = 10

Common Failure Modes: Parametric shifts in leakage and mechanical failure

Common Failure Mechanisms: Corrosion or contaminants on or within the package materials. Poor package sealing

Military Reference: MIL-STD-750, Method 1021

SOLDERABILITY

The purpose of this test is to measure the ability of device leads/terminals to be soldered after an extended period of storage (shelf life).

Typical Test Conditions: Steam aging = 8 hours, Flux = R, Solder = Sn60, Sn63

Common Failure Modes: Pin holes, dewetting, non-wetting

Common Failure Mechanisms: Poor plating, contaminated leads

Military Reference: MIL-STD-750, Method 2026

SOLDER HEAT

This test is used to measure the ability of a device to withstand the temperatures as may be seen in wave soldering operations. Electrical testing is the endpoint criterion for this stress.

Typical Test Conditions: Solder Temperature = 260°C , $t = 10$ seconds

Common Failure Modes: Parameter shifts, mechanical failure

Common Failure Mechanisms: Poor package design

Military Reference: MIL-STD-750, Method 2031

STEADY STATE OPERATING LIFE (SSOL)

The purpose of this test is to evaluate the bulk stability of the die and to generate defects resulting from manufacturing aberrations that are manifested as time and stress-dependent failures.

Typical Test Conditions: $T_A = 25^\circ\text{C}$, $P_D =$ Data Book maximum rating, $t = 16$ to 1000 hours

Common Failure Modes: Parametric shifts and catastrophic

Common Failure Mechanisms: Foreign material, crack die, bulk die, metallization, wire and die bond defects

Military Reference: MIL-STD-750, Method 1026

TEMPERATURE CYCLING (AIR TO AIR)

The purpose of this test is to evaluate the ability of the device to withstand both exposure to extreme temperatures and transitions between temperature extremes. This testing will also expose excessive thermal mismatch between materials.

Typical Test Conditions: $T_A = -65^\circ\text{C}$ to 200°C , cycle = 10 to 1000

Common Failure Modes: Parametric shifts and catastrophic

Common Failure Mechanisms: Wire bond, cracked or lifted die and package failure

Military Reference: MIL-STD-750, Method 1051

THERMAL SHOCK (LIQUID TO LIQUID)

The purpose of this test is to evaluate the ability of the device to withstand both exposure to extreme temperatures and sudden transitions between temperature extremes. This testing will also expose excessive thermal mismatch between materials.

Typical Test Conditions: $T_A = 0^\circ\text{C}$ to 100°C , cycles = 10 to 1000

Common Failure Modes: Parametric shifts and catastrophic

Common Failure Mechanisms: Wire bond, cracked or lifted die and package failure

Military Reference: MIL-STD-750, Method 1056

6 VARIABLE FREQUENCY VIBRATION

This test is used to examine the ability of the device to withstand deterioration due to mechanical resonance.

Typical Test Conditions: Peak acceleration = 20 g's, Frequency range = 20 Hz to 20 kHz, $t = 48$ minutes.

Common Failure Modes: Open, short, excessive leakage, mechanical failure

Common Failure Mechanisms: Die and wire bonds, cracked die, package defects

Military Reference: MIL-STD-750, Method 2056

CHAPTER 4: ZENER DIODE CHARACTERISTICS

Introduction

At first glance the zener diode is a simple device consisting of one P-N junction with controlled breakdown voltage properties. However, when considerations are given to the variations of temperature coefficient, zener impedance, thermal time response, and capacitance, all of which are a function of the breakdown voltage (from 1.8 to 400 V), a much more complicated picture arises. In addition to the voltage spectrum, a variety of power packages are on the market with a variation of dice area inside the encapsulation.

This chapter is devoted to sorting out the important considerations in a “typical” fashion. For exact details, the data sheets must be consulted. However, much of the information contained herein is supplemental to the data sheet curves and will broaden your understanding of zener diode behavior.

Specifically, the following main subjects will be detailed:

Basic DC Volt-Ampere Characteristics

Impedance versus Voltage and Current

Temperature Coefficient versus Voltage and Current

Power Derating

Mounting

Thermal Time Response — Effective Thermal Impedance

Surge Capabilities

Frequency Response — Capacitance and Switching Effects

Basic Zener Diode DC Volt-Ampere Characteristics

Reverse and forward volt-ampere curves are represented in Figure 4-1 for a typical zener diode. The three areas — forward, leakage, and breakdown — will each be examined.

Forward DC Characteristics

The forward characteristics of a zener diode are essentially identical with an “ordinary” rectifier and is shown in Figure 4-2. The volt-ampere curve follows the basic diode equation of $I_F = I_{R0} e^{qV/KT}$ where KT/q equals about 0.026 volts at room temperature and I_R (reverse leakage current) is dependent upon the doping levels of the P-N junction as well as the area. The actual plot of V_F versus I_F deviates from the theoretical due to slightly “fixed” series resistance of the lead wire, bonding contacts and some bulk effects in the silicon.

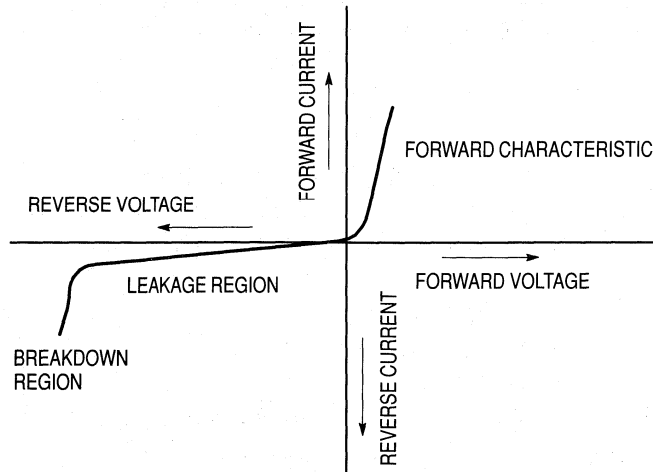

Figure 4-1. Typical Zener Diode DC V-I Characteristics (Not to Scale)

While the common form of the diode equation suggests that I_R is constant, in fact I_R is itself strongly temperature dependent. The rapid increase in I_R with increasing temperature dominates the decrease contributed by the exponential term in the diode equation. As a result, the forward current increases with increasing temperature. Figure 4-2 shows a forward characteristic temperature dependence for a typical zener. These curves indicate that for a constant current, an increase in temperature causes a decrease in forward voltage. The voltage temperature coefficient values are typically in the range of -1.4 to -2 mV/°C.

Leakage DC Characteristics

6

When reverse voltage less than the breakdown is applied to a zener diode, the behavior of current is similar to any back-biased silicon P-N junction. Ideally, the reverse current would reach a level at about one volt reverse voltage and remain constant until breakdown is reached. There are both theoretical and practical reasons why the typical V-I curve will have a definite slope to it as seen in Figure 4-3. Multiplication effects and charge generation sites are present in a zener diode which dictate that reverse current (even at low voltages) will increase with voltage. In addition, surface charges are ever present across P-N junctions which appear to be resistive in nature.

The leakage currents are generally less than one microampere at 150°C except with some large area devices. Quite often a leakage specification at 80% or so of breakdown voltage is used to assure low reverse currents.

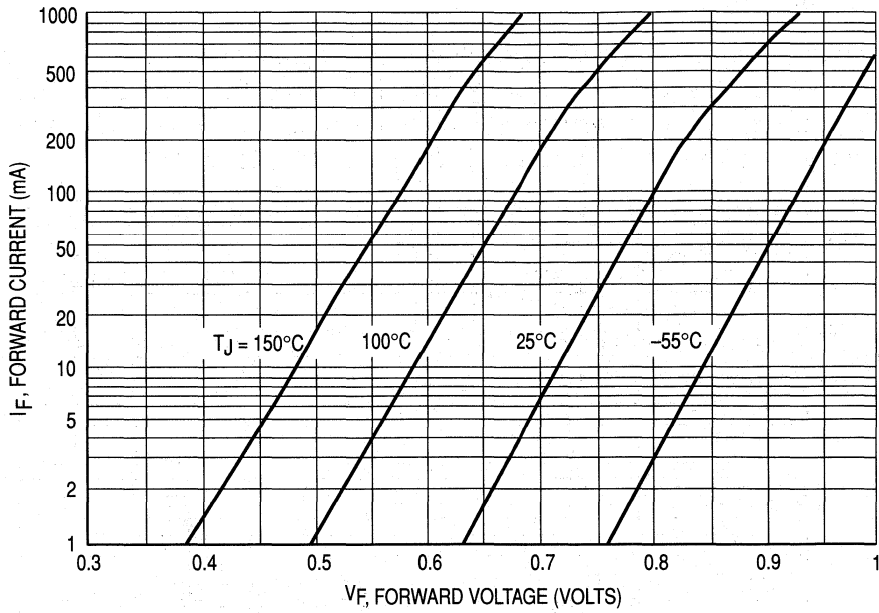

Figure 4-2. Typical Forward Characteristics of Zener Diodes

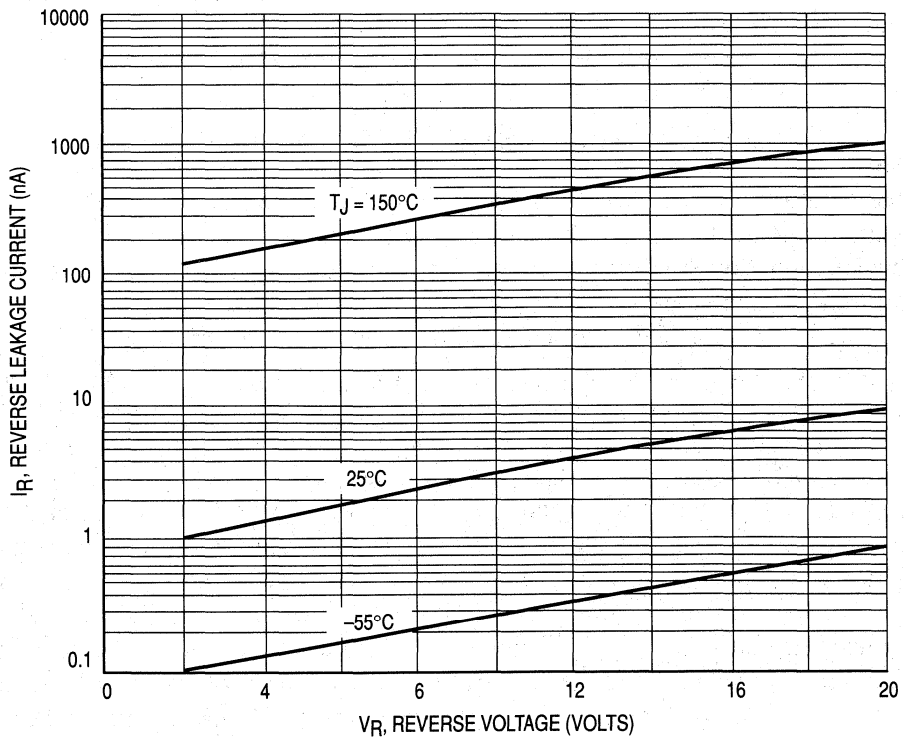

Figure 4-3. Typical Leakage Current versus Voltage

Voltage Breakdown

At some definite reverse voltage, depending on the doping levels (resistivity) of the P-N junction, the current will begin to avalanche. This is the so-called “zener” or “breakdown” area and is where the device is usually biased during use. A typical family of breakdown curves showing the effect of temperature is illustrated in Figure 4-4.

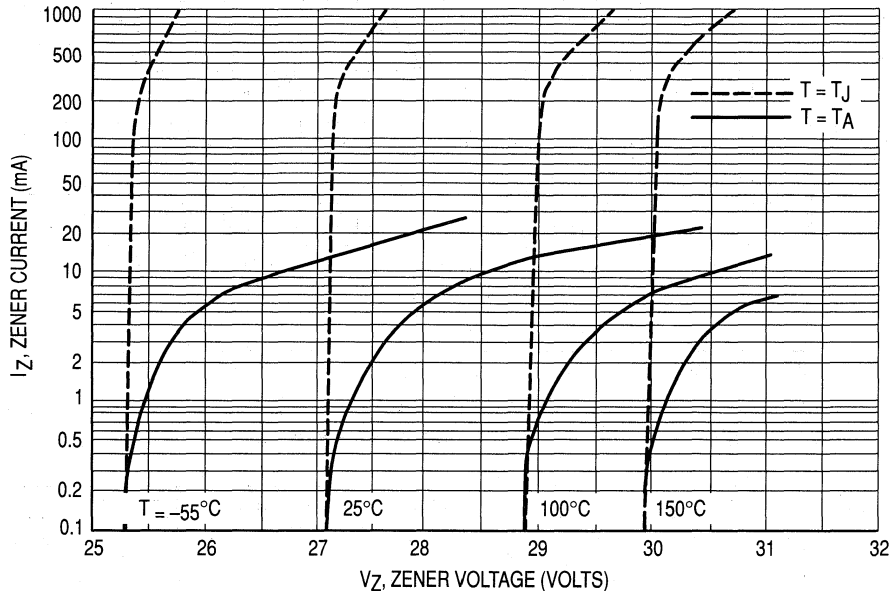

Figure 4-4. Typical Zener Characteristic Variation with Temperature

Between the minimum currents shown in Figure 4-4 and the leakage currents, there is the “knee” region. The avalanche mechanism may not occur simultaneously across the entire area of the P-N junction, but first at one microscopic site, then at an increasing number of sites as further voltage is applied. This action can be accounted for by the “microplasma discharge” theory and correlates with several breakdown characteristics.

An exaggerated view of the knee region is shown in Figure 4-5. As can be seen, the breakdown or avalanche current does not increase suddenly, but consists of a series of smoothly rising current versus voltage increments each with a sudden break point.

At the lowest point, the zener resistance (slope of the curve) would test high, but as current continues to climb, the resistance decreases. It is as though each discharge site has high resistance with each succeeding site being in parallel until the total resistance is very small.

In addition to the resistive effects, the micro plasmas may act as noise generators. The exact process of manufacturing affects how high the noise will be, but in any event there will be some noise at the knee, and it will diminish considerably as current is allowed to increase.

Since the zener impedance and the temperature coefficient are of prime importance when using the zener diode as a reference device, the next two sections will expand on these points.

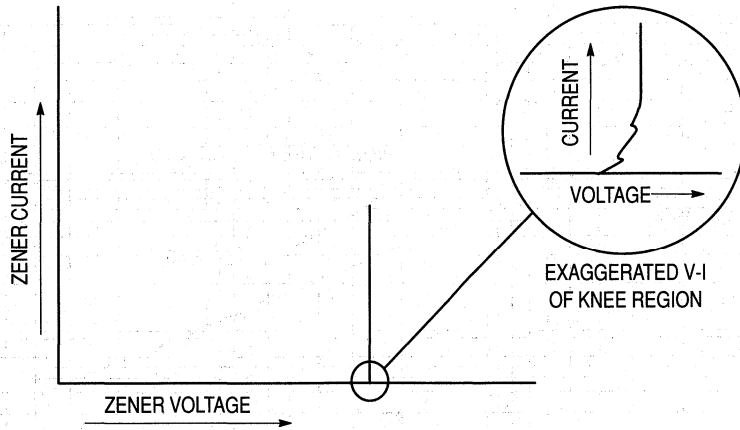

Figure 4-5. Exaggerated V-I Characteristics of the Knee Region

Zener Impedance

The slope of the $V_Z - I_Z$ curve (in breakdown) is defined as zener impedance or resistance. The measurement is generally done with a 60 Hz (on modern, computerized equipment this test is being done at 1 kHz) current variation whose value is 10% in rms of the dc value of the current. (That is, ΔI_Z peak to peak = $0.282 I_Z$.) This is really not a small signal measurement but is convenient to use and gives repeatable results.

The zener impedance always decreases as current increases, although at very high currents (usually beyond I_Z max) the impedance will approach a constant. In contrast, the zener impedance decreases very rapidly with increasing current in the knee region. Motorola specifies most zener diode impedances at two points: I_{ZT} and I_{ZK} . The term I_{ZT} usually is at the quarter power point, and I_{ZK} is an arbitrary low value in the knee region. Between these two points a plot of impedance versus current on a log-log scale is close to a straight line. Figure 4-6 shows a typical plot of Z_Z versus I_Z for a 20 volt–500 mW zener. The worst case impedance between I_{ZT} and I_{ZK} could be approximated by assuming a straight line function on a log-log plot; however, at currents above I_{ZT} or below I_{ZK} a projection of this line may give erroneous values.

The impedance variation with voltage is much more complex. First of all, zeners below 6 volts or so exhibit “field emission” breakdown converting to “avalanche” at higher currents. The two breakdowns behave somewhat differently with “field emission” associated with high impedance and negative temperature coefficients and “avalanche” with lower impedance and positive temperature coefficients.

A V-I plot of several low voltage 500 mW zener diodes is shown in Figure 4-7. It is seen that at some given current (higher for the lower voltage types) there is a fairly sudden decrease in the slope of $\Delta V/\Delta I$. Apparently, this current is the transition from one type of breakdown to the other. Above 6 volts the curves would show a gradual decrease of $\Delta V/\Delta I$ rather than an abrupt change, as current is increased.

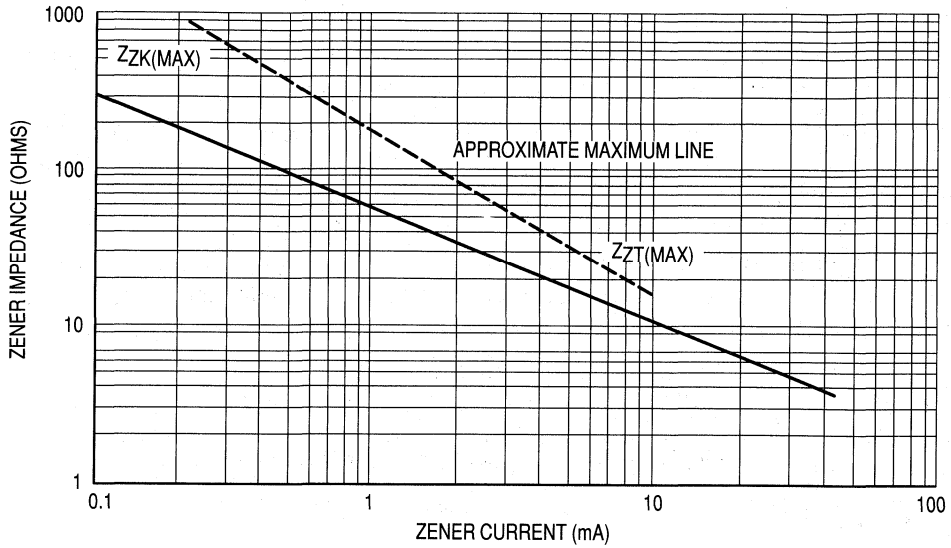

Figure 4-6. Zener Impedance versus Zener Current

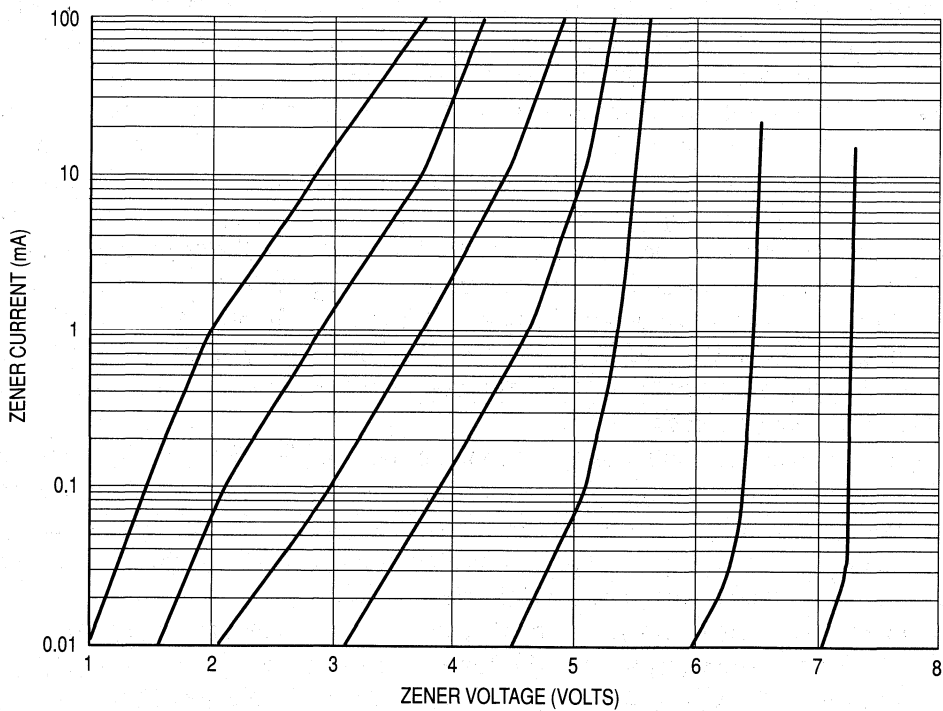

Figure 4-7. Zener Current versus Zener Voltage (Low Voltage Region)

6

Possibly the plots shown in Figure 4-8 of zener impedance versus voltage at several constant I_Z 's more clearly points out this effect. It is obvious that zener diodes whose breakdowns are about 7 volts will have remarkably low impedance.

However, this is not the whole picture. A zener diode figure of merit as a regulator could be Z_Z/V_Z . This would give some idea of what percentage change of voltage could be expected for some given change in current. Of course, a low Z_Z/V_Z is desirable. Generally zener current must be decreased as voltage is increased to prevent excessive power dissipation; hence zener impedance will rise even higher and the "figure of merit" will become higher as voltage increases. This is the case with I_{ZT} taken as the test point. However, if I_{ZK} is used as a comparison level in those devices which keep a constant I_{ZK} over a large range of voltage, the "figure of merit" will exhibit a bowl-shaped curve — first decreasing and then increasing as voltage is increased. Typical plots are shown in Figure 4-9. The conclusion can be reached that for uses where wide swings of current may occur and the quiescent bias current must be high, the lower voltage zener will provide best regulation, but for low power applications, the best performance could be obtained between 50 and 100 volts.

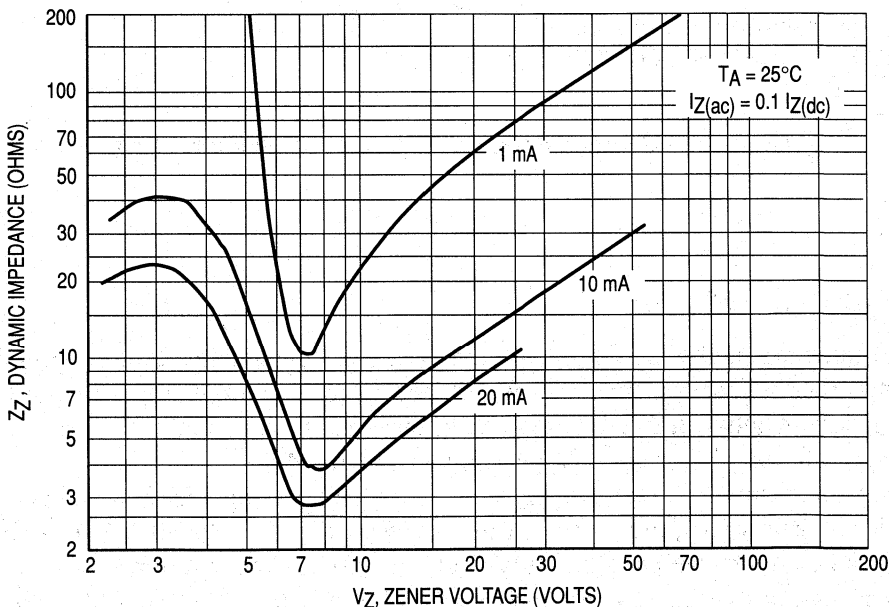
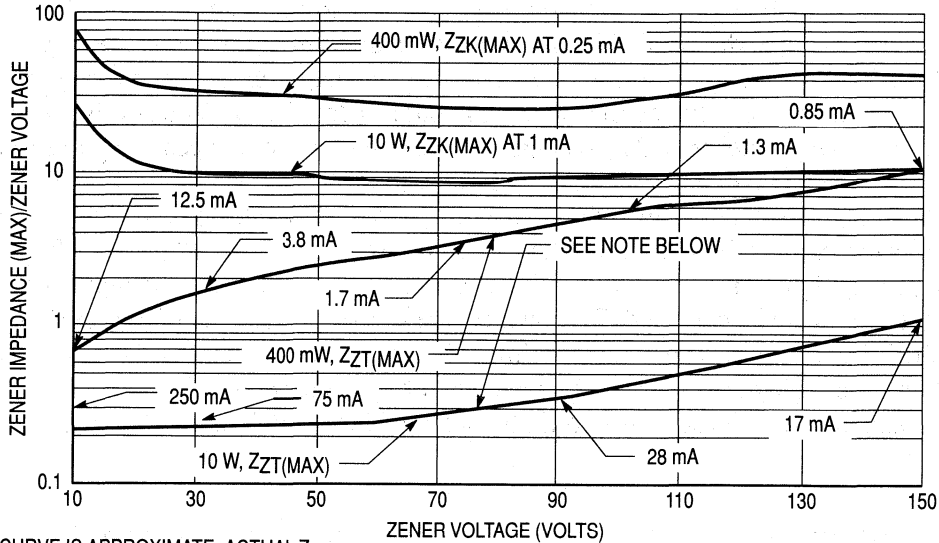

Figure 4-8. Dynamic Zener Impedance (Typical) versus Zener Voltage



(NOTE: CURVE IS APPROXIMATE, ACTUAL $Z_Z(\text{MAX})$ IS ROUNDED OFF TO NEAREST WHOLE NUMBER ON A DATA SHEET)

Figure 4-9. Figure of Merit: $Z_Z(\text{MAX})/V_Z$ versus V_Z (400 mW & 10 W Zeners)

Temperature Coefficient

Below three volts and above eight volts the zener voltage change due to temperature is nearly a straight line function and is almost independent of current (disregarding self-heating effects). However, between three and eight volts the temperature coefficients are not a simple affair. A typical plot of TC versus V_Z is shown in Figure 4-10.

Any attempt to predict voltage changes as temperature changes would be very difficult on a "typical" basis. (This, of course, is true to a lesser degree below three volts and above eight volts since the curve shown is a typical one and slight deviations will exist with a particular zener diode.) For example, a zener which is 5 volts at 25°C could be from 4.9 to 5.05 volts at 75°C depending on the current level. Whereas, a zener which is 9 volts at 25°C would be close to 9.3 volts at 75°C for all useful current levels (disregarding impedance effects).

As was mentioned, the situation is further complicated by the normal deviation of TC at a given current. For example, for 7.5 mA the normal spread of TC (expressed in $\%/^{\circ}\text{C}$) is shown in Figure 4-11. This is based on limited samples and in no manner implies that all Motorola zeners between 2 and 12 volts will exhibit this behavior. At other current levels similar deviations would occur.

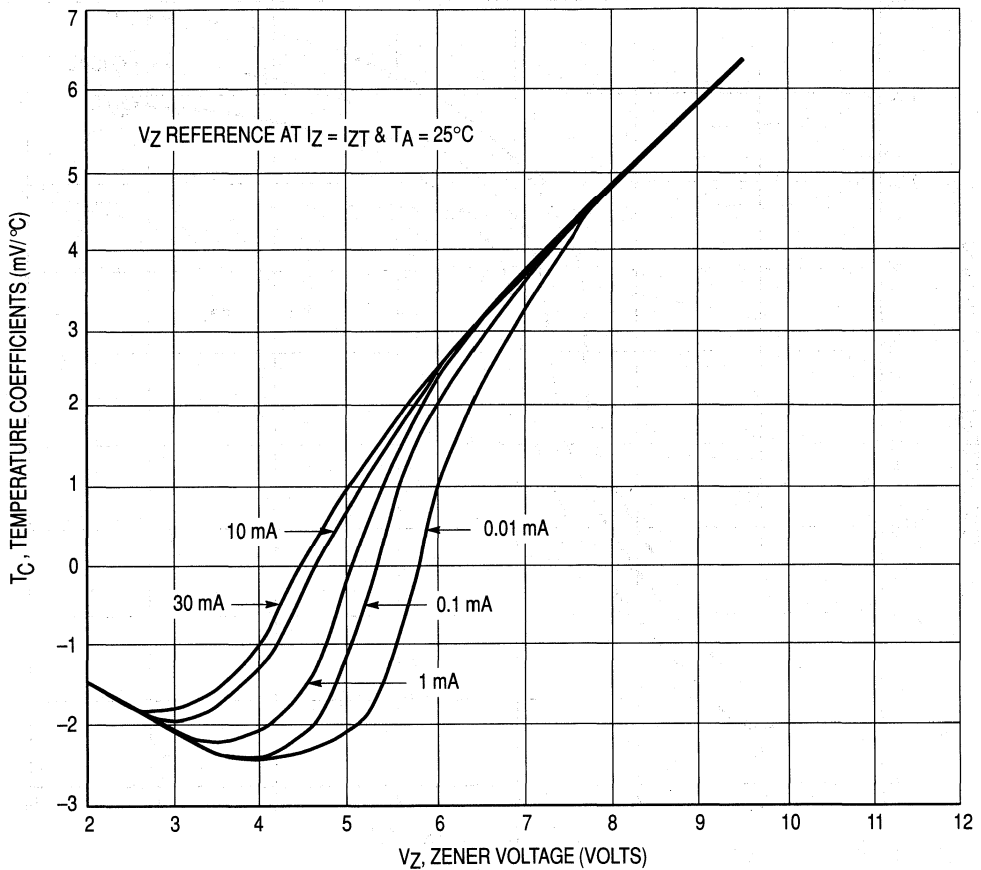

Figure 4-10. Temperature Coefficient versus Zener Voltage at 25°C Conditions Typical

Obviously, all of these factors make it very difficult to attempt any calculation of precise voltage shift due to temperature. Except in devices with specified maximum T.C., no “worse case” design is possible. Information concerning the Motorola temperature compensated or reference diodes is given in Chapter 5.

Typical temperature characteristics for a broad range of voltages is illustrated in Figure 4-12. This graphically shows the significant change in voltage for high voltage devices (about a 20 volt increase for a 100°C increase on a 200 volt device).

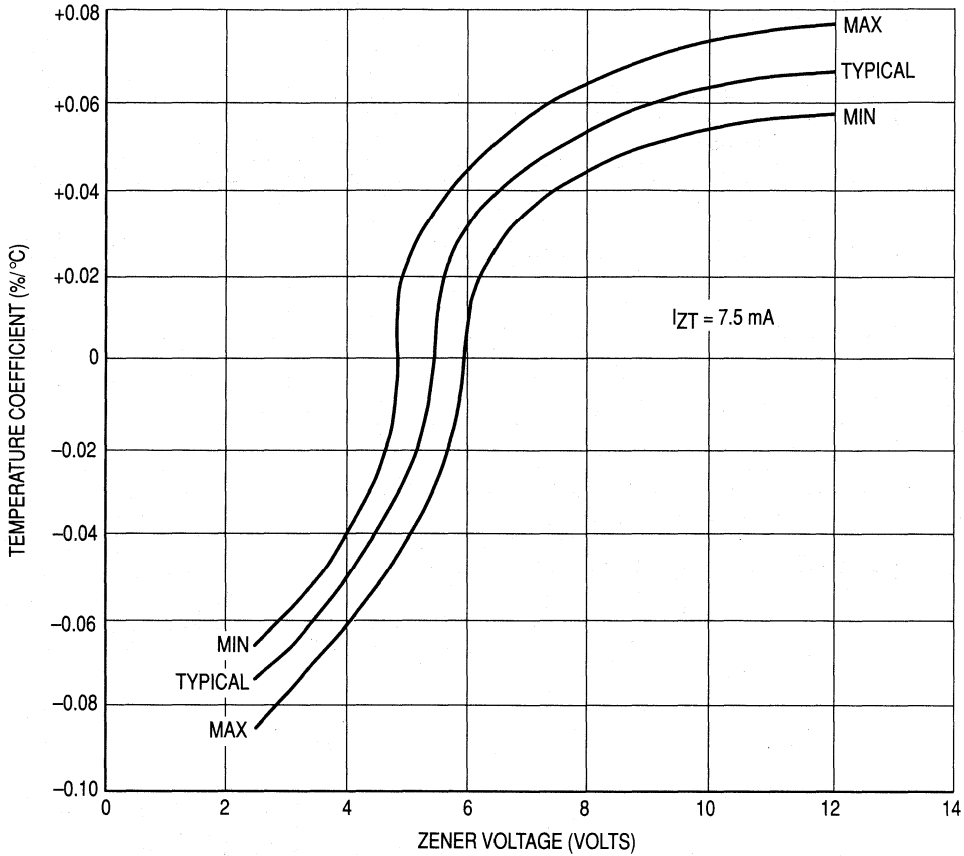

Figure 4-11. Temperature Coefficient Spread versus Zener Voltage

Power Derating and Mounting

The zener diode like any other semiconductor has a maximum junction temperature. This limit is somewhat arbitrary and is set from a reliability viewpoint. Most semiconductors exhibit an increasing failure rate as temperature increases. At some temperature, the solder will melt or soften and the failure rate soars. The 175°C to 200°C junction temperature rating is quite safe from solder failures and still has a very low failure rate.

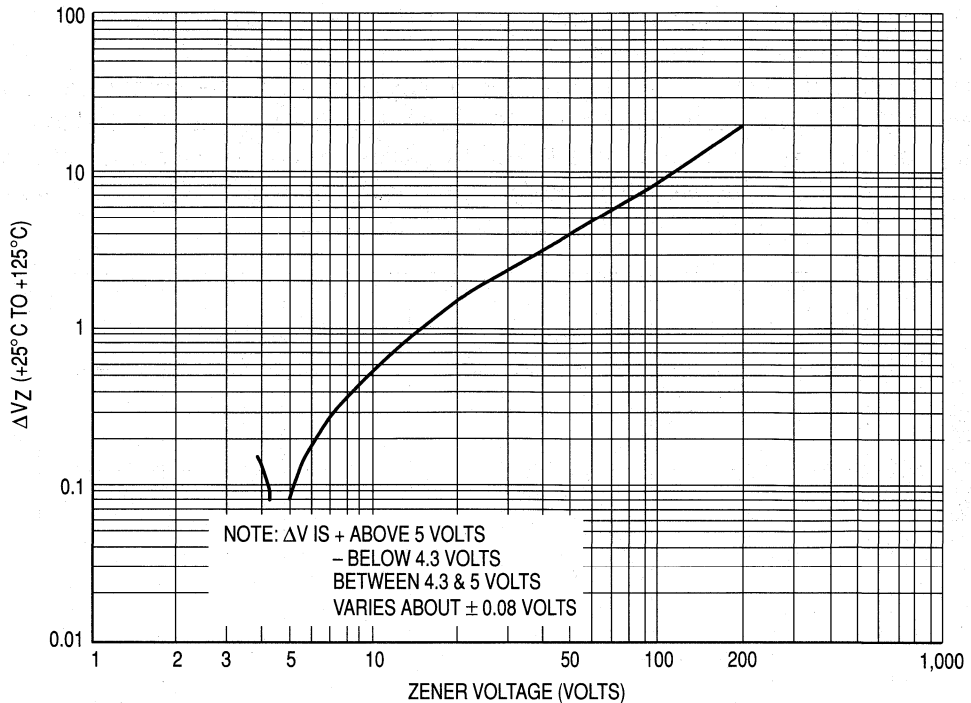

Figure 4-12. Typical Temperature Characteristics

In order that power dissipated in the device will never cause the junction to rise beyond 175°C or 200°C (depending on the device), the relation between temperature rise and power must be known. Of course, the thermal resistance ($R_{\theta JA}$ or $R_{\theta JL}$) is the factor which relates power and temperature in the well known “Thermal Ohm’s Law” relation:

$$\Delta T = T_J - T_A = R_{\theta JA} P_Z \quad (4-1)$$

and

$$\Delta T = T_J - T_L = R_{\theta JL} P_Z \quad (4-2)$$

where

- T_J = Junction temperature
- T_A = Ambient temperature
- T_L = Lead temperature
- $R_{\theta JA}$ = Thermal resistance junction to ambient
- $R_{\theta JL}$ = Thermal resistance junction to lead
- P_Z = Zener power dissipation

Obviously, if ambient or lead temperature is known and the appropriate thermal resistance for a given device is known, the junction temperature could be precisely calculated by simply measuring the zener dc current and voltage ($P_Z = I_Z V_Z$). This would be helpful to calculate

voltage change versus temperature. However, only maximum and typical values of thermal resistance are given for a family of zener diodes. So only “worst case” or typical information could be obtained as to voltage changes.

The relations of equations 4-1 and 4-2 are usually expressed as a graphical derating of power versus the appropriate temperature. Maximum thermal resistance is used to generate the slope of the curve. An example of a 400 milliwatt device derated to the ambient temperature and a 1 watt device derated to the lead temperature are shown in Figures 4-13 and 4-14.

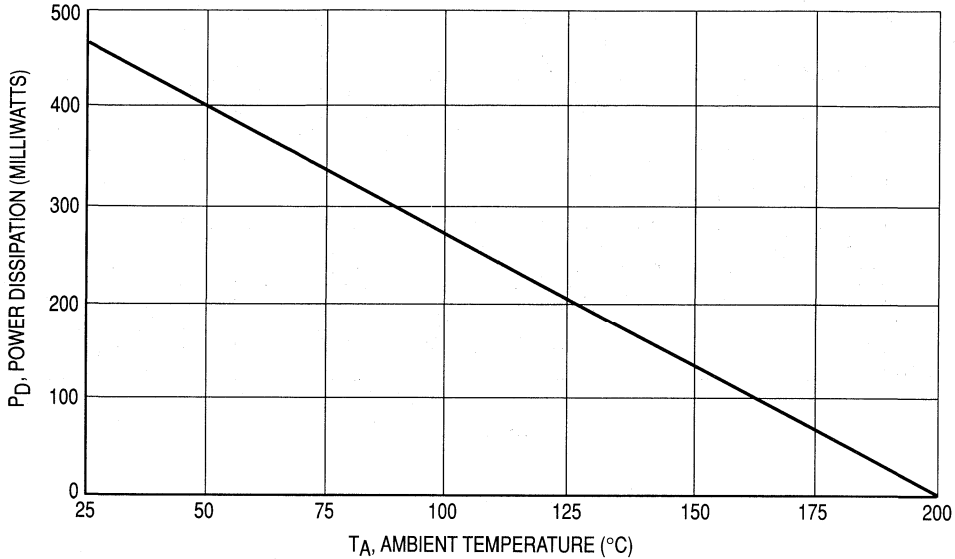

Figure 4-13. 400 mW Power Temperature Derating Curve

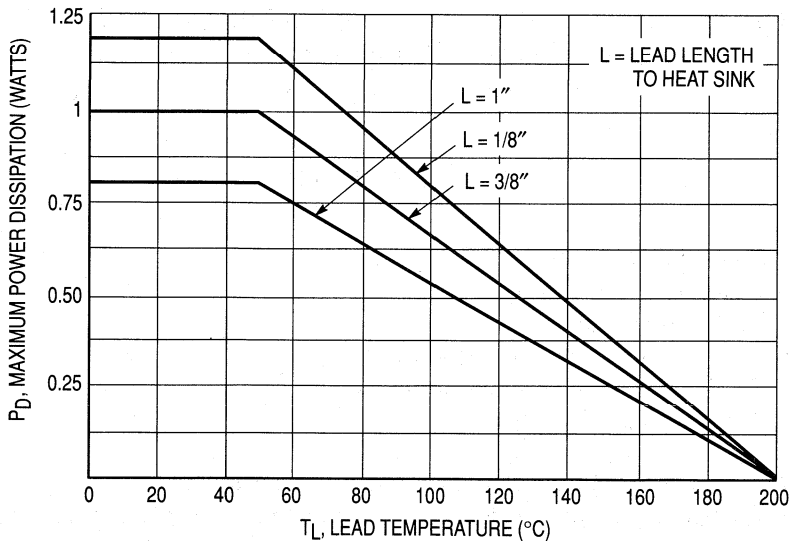

Figure 4-14. Power Temperature Derating Curve

6

A lead mounted device can have its power rating increased by shortening the lead length and “heatsinking” the ends of the leads. This effect is shown in Figure 4-15, for the 1N4728, 1 watt zener diode.

Each zener has a derating curve on its data sheet and steady state power can be set properly. However, temperature increases due to pulse use are not so easily calculated. The use of “Transient Thermal Resistance” would be required. The next section expounds upon transient thermal behavior as a function of time and surge power.

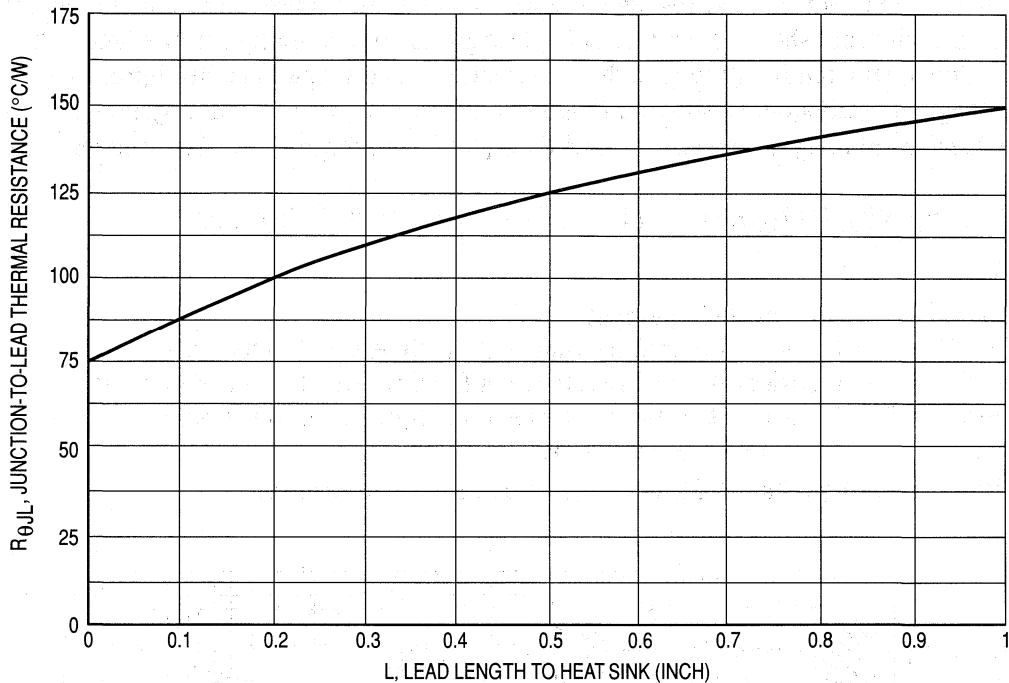

Figure 4-15. Typical 1N4728 Thermal Resistance versus Lead Length

Thermal Time Response

Early studies of zener diodes indicated that a “thermal time constant” existed which allowed calculation of temperature rise as a function of power pulse height, width, and duty cycle. More precise measurements have shown that temperature response as a function of time cannot be represented as a simple time constant. Although as shown in the preceding section, the steady state conditions are analogous in every way to an electrical resistance; a simple “thermal capacitance” placed across the resistor is not the true equivalent circuit. Probably a series of parallel R-C networks or lumped constants representing a thermal transmission line would be more accurate.

Fortunately a concept has developed in the industry wherein the exact thermal equivalent circuit need not be found. If one simply accepts the concept of a thermal resistance which varies with time in a predictable manner, the situation becomes very practical. For each family of zener diodes, a “worst case” transient thermal resistance curve may be generated.

The main use of this transient $R_{\theta JL}$ curve is when the zener is used as a clipper or a protective device. First of all, the power wave shape must be constructed. (Note, even though the power-transient thermal resistance indicates reasonable junction temperatures, the device still may fail if the peak current exceeds certain values. Apparently a current crowding effect occurs which causes the zener to short. This is discussed further in this section.)

Transient Power-Temperature Effects

A typical transient thermal resistance curve is shown in Figure 4-16. This is for a lead mounted device and shows the effect of lead length to an essentially infinite heatsink.

To calculate the temperature rise, the power surge wave shape must be approximated by its rectangular equivalent as shown in Figure 4-17. In case of an essentially non-recurrent pulse, there would be just one pulse, and $\Delta T = R_{\theta T1} P_p$. In the general case, it can be shown that

$$\Delta T = [DR_{\theta JA}(ss) + (1 - D) R_{\theta T1} + T + R_{\theta T1} - R_{\theta T}] P_p$$

where

- D = Duty cycle in percent
- $R_{\theta T1}$ = Transient thermal resistance at the time equal to the pulse width
- $R_{\theta T}$ = Transient thermal resistance at the time equal to pulse interval
- $R_{\theta T1} + T$ = Transient thermal resistance at the time equal to the pulse interval plus one more pulse width.

$R_{\theta JA}(ss)$ or $R_{\theta JL}(ss)$ = Steady state value of thermal resistance

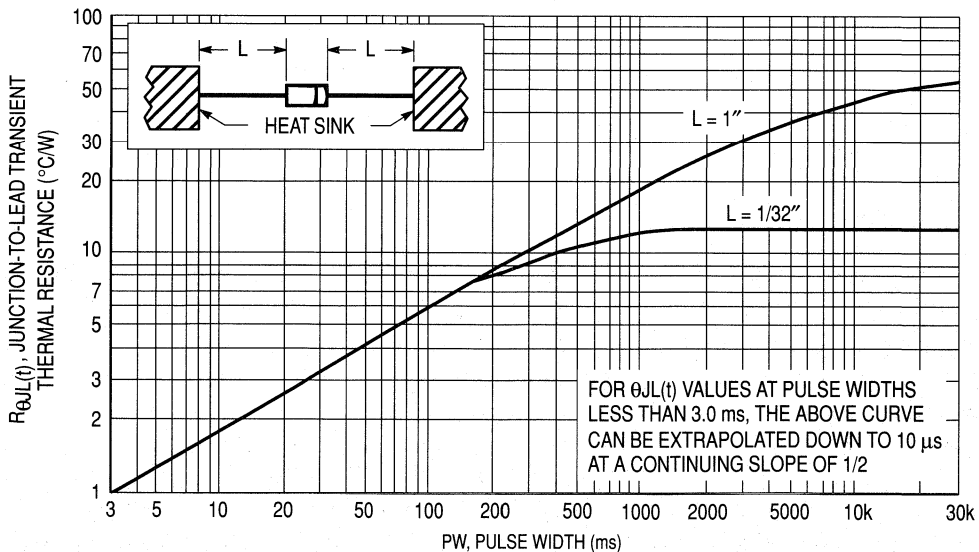

Figure 4-16. Typical Transient Thermal Resistance (For Axial Lead Zener)

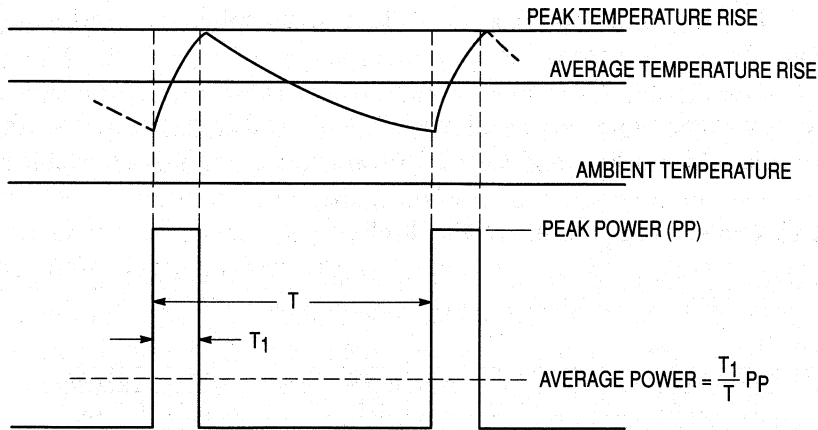

Figure 4-17. Relation of Junction Temperature to Power Pulses

This method will predict the temperature rise at the end of the power pulse after the chain of pulses has reached equilibrium. In other words, the average power will have caused an average temperature rise which has stabilized, but a temperature “ripple” is present.

Example: (Use curve in Figure 4-16)

$P_p = 5$ watt (Lead length $1/32''$)

$D = 0.1$

$T_1 = 10$ ms

$T = 100$ ms

$R_{\theta JA(ss)} = 12^\circ\text{C/W}$ (for $1/32''$ lead length)

Then

$R_{\theta T1} = 1.8^\circ\text{C/W}$

$R_{\theta T} = 5.8^\circ\text{C/W}$

$R_{\theta T1} + T = 6^\circ\text{C/W}$

And

$\Delta T = [0.1 \times 12 + (1 - 0.1) 6 + 1.8 - 5.8] 5$

$\Delta T = 13^\circ\text{C}$

Or at $T_A = 25^\circ$, $T_J = 38^\circ\text{C}$ peak

Surge Failures

If no other considerations were present, it would be a simple matter to specify a maximum junction temperature no matter what pulses are present. However, as has been noted, apparently other fault conditions prevail. The same group of devices for which the transient thermal curves were generated were tested by subjecting them to single shot power pulses. A failure was defined as a significant shift of leakage or zener voltage, or of course opens

or shorts. Each device was measured before and after the applied pulse. Most failures were shifts in zener voltage. The results are shown in Figure 4-18.

Attempts to correlate this to the transient thermal resistance work quite well on a typical basis. For example, assuming a value for 1 ms of 90 watts and 35 watts at 10 ms, the predicted temperature rise would be 180°C and 190°C. But on a worst case basis, the temperature rises would be about one half these values or junction temperatures, on the order of 85°C to 105°C, which are obviously low. Apparently at very high power levels a current restriction occurs causing hot spots. There was no apparent correlation of zener voltage or current on the failure points since each group of failures contained a mixture of voltages.

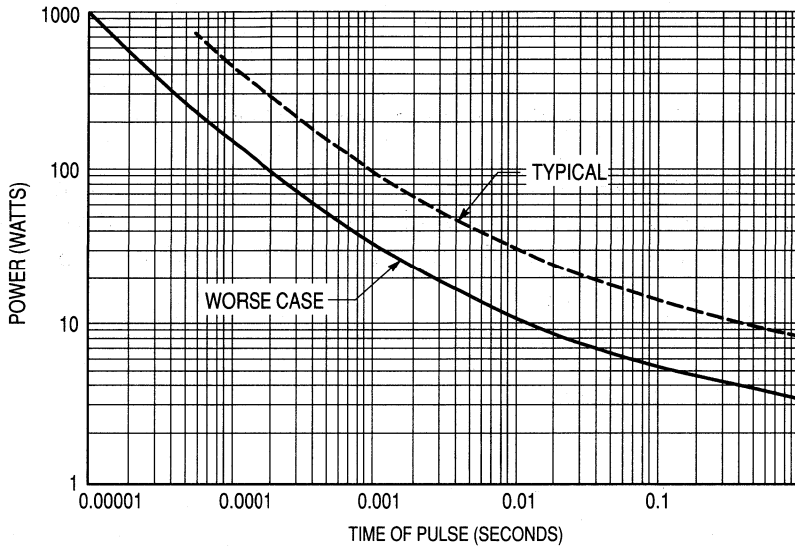

Figure 4-18. One Shot Power Failure Axial Lead Zener Diode

6

Voltage versus Time

Quite often the junction temperature is only of academic interest, and the designer is more concerned with the voltage behavior versus time. By using the transient thermal resistance, the power, and the temperature coefficient, the designer could generate V_Z versus time curves. The Motorola zener diode test group has observed device voltages versus time until the thermal equilibrium was reached. A typical curve is shown for a lead mounted low wattage device in Figure 4-19 where the ambient temperature was maintained constant. It is seen that voltage stabilizes in about 100 seconds for 1 inch leads.

Since information contained in this section may not be found on data sheets it is necessary for the designer to contact the factory when using a zener diode as a surge suppressor. Additional information on transient suppression application is presented elsewhere in this book.

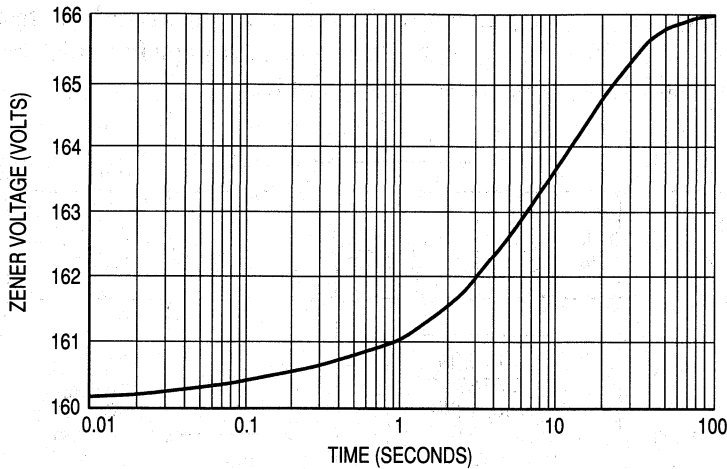

Figure 4-19. Zener Voltage (Typical) versus Time for Step Power Pulses (500 mW Lead Mounted Devices)

Frequency and Pulse Characteristics

The zener diode may be used in applications which require a knowledge of the frequency response of the device. Of main concern are the zener resistance (usually specified as “impedance”) and the junction capacitance. The capacitance curves shown in this section are typical.

Zener Capacitance

Since zener diodes are basically PN junctions operated in the reverse direction, they display a capacitance that decreases with increasing reverse voltage. This is so because the effective width of the PN junction is increased by the removal of charges (holes and electrons) as reverse voltage is increased. This decrease in capacitance continues until the zener breakdown region is entered; very little further capacitance change takes place, owing to the now fixed voltage across the junction. The value of this capacitance is a function of the material resistivity, ρ , (amount of doping — which determines V_Z nominal), the diameter, D , of junction or dice size (determines amount of power dissipation), the voltage across the junction V_C , and some constant, K . This relationship can be expressed as:

$$C_C = n \sqrt{\frac{KD^4}{\rho V_C}}$$

After the junction enters the zener region, capacitance remains relatively fixed and the AC resistance then decreases with increasing zener current.

TEST CIRCUIT CONSIDERATIONS: A capacitive bridge was used to measure junction capacitance. In this method the zener is used as one leg of a bridge that is balanced for both DC at a given reverse voltage and for AC (the test frequency 1 MHz). After balancing, the

variable capacitor used for balancing is removed and its value measured on a test instrument. The value thus indicated is the zener capacitance at reverse voltage for which bridge balance was obtained. Figure 4-20 shows capacitance test circuit.

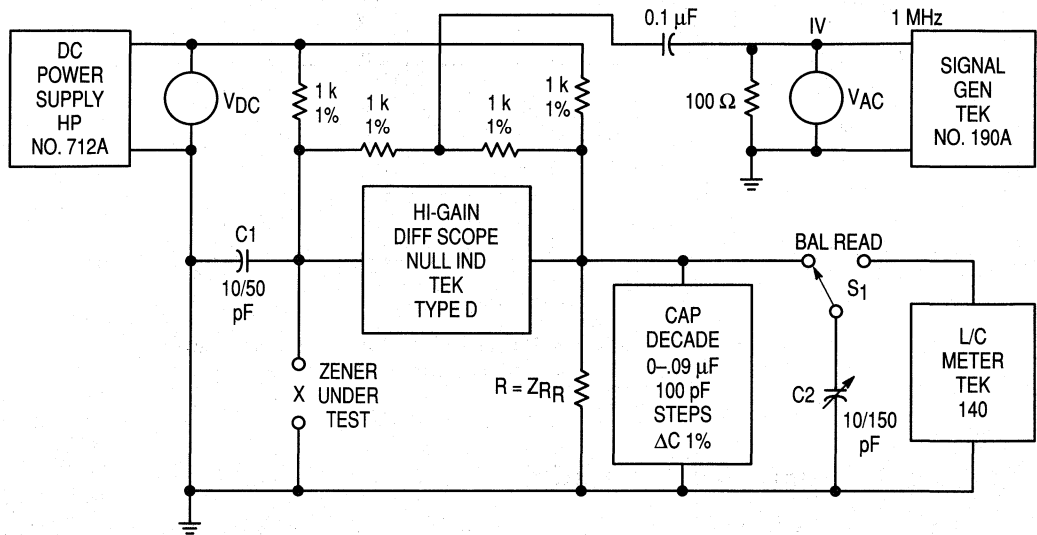

Figure 4-20. Capacitance Test Circuit

Figure 4-21 is a plot of junction capacitance for diffused zener diode units versus their nominal operating voltage. Capacitance is the value obtained with reverse bias set at one-half the nominal V_Z . The plot of the voltage range from 6.8 V to 200 V, for three dice sizes, covers most Motorola diffused-junction zeners. Consult specific data sheets for capacitance values.

Figures 4-22, 4-23, and 4-24 show plots of capacitance versus reverse voltage for units of various voltage ratings in each of the three dice sizes. Junction capacitance decreases as reverse voltage increases to the zener region. This change in capacitance can be expressed as a ratio which follows a one-third law, and $C_1/C_2 = (V_2/V_1)^{1/3}$. This law holds only from the zener voltage down to about 1 volt, where the curve begins to flatten out. Figure 4-25 shows this for a group of low wattage units.

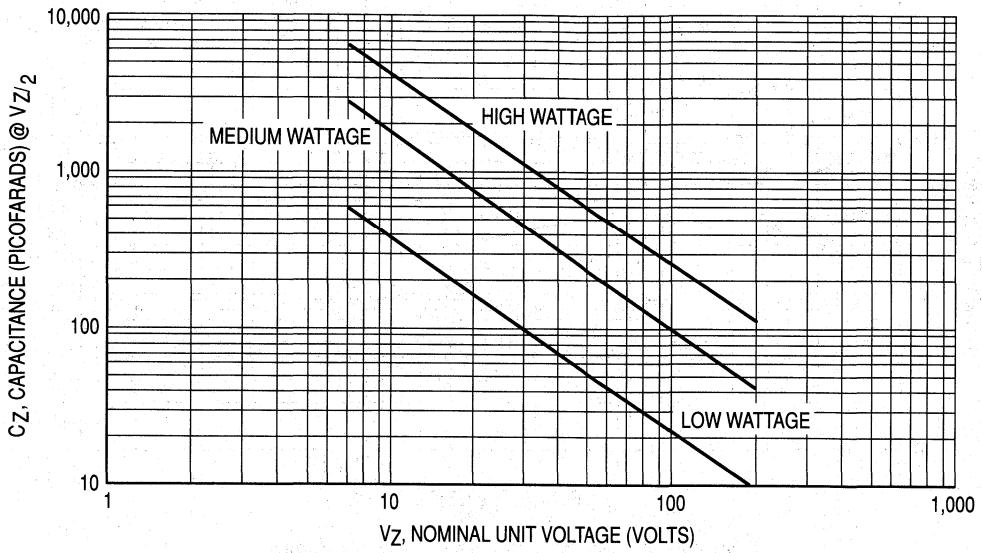

Figure 4-21. Capacitance versus Voltage

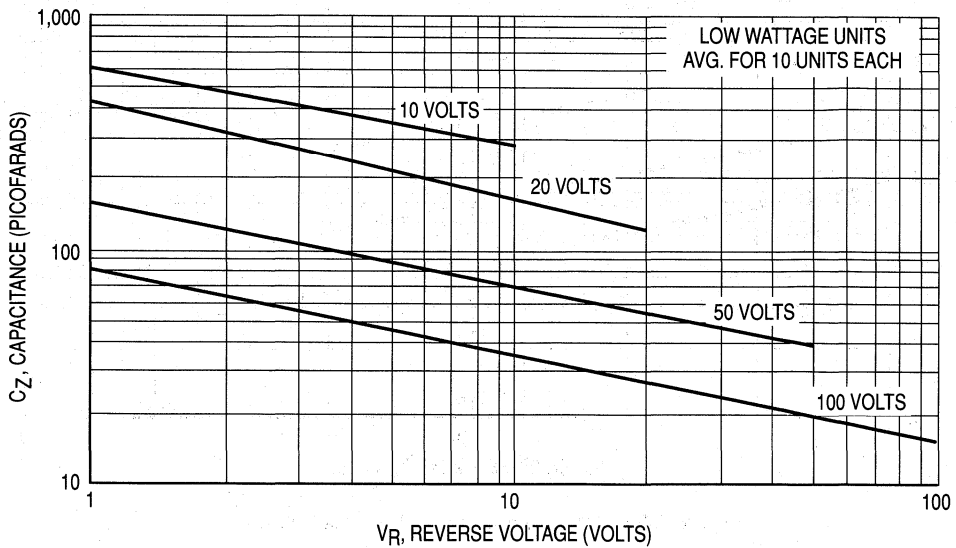

Figure 4-22. Capacitance versus Reverse Voltage

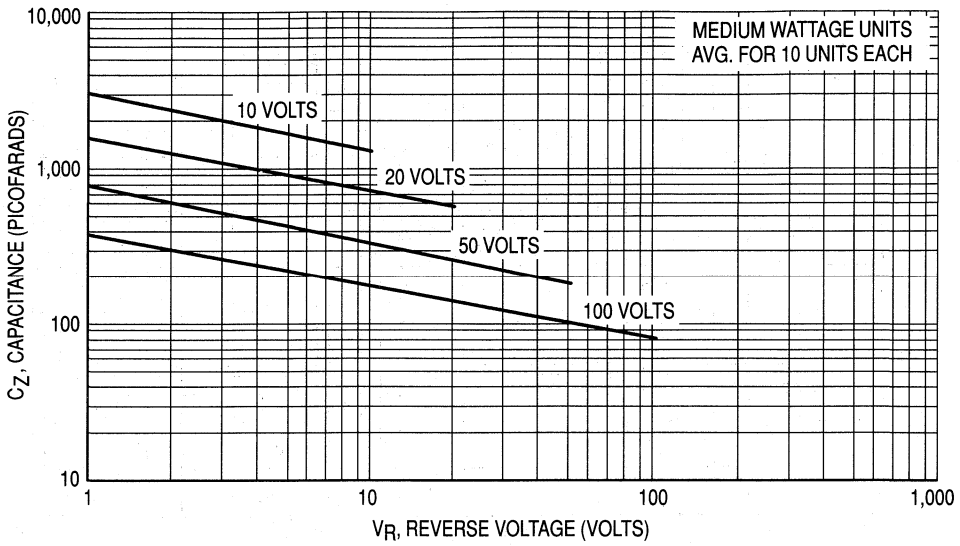

Figure 4-23. Capacitance versus Reverse Voltage

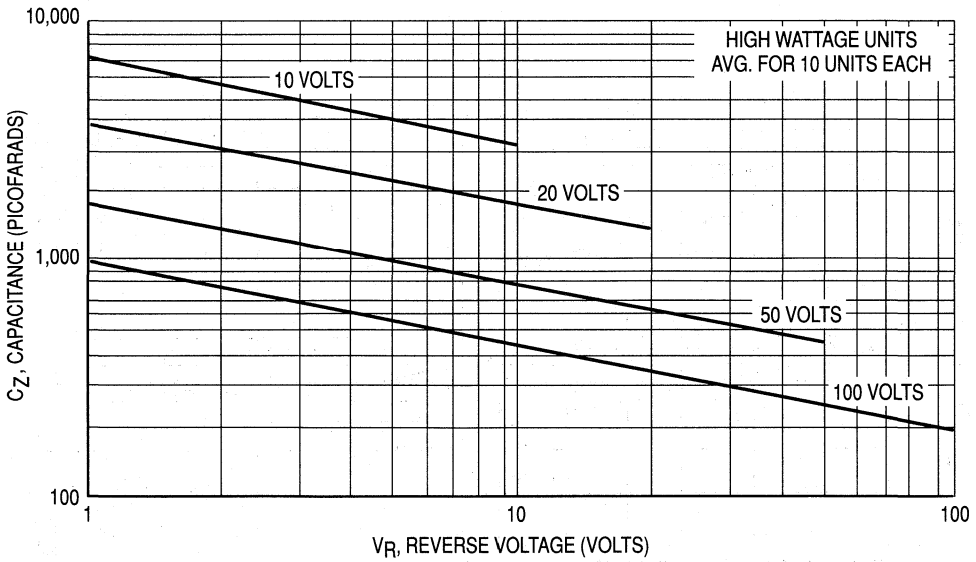

Figure 4-24. Capacitance versus Reverse Voltage

6

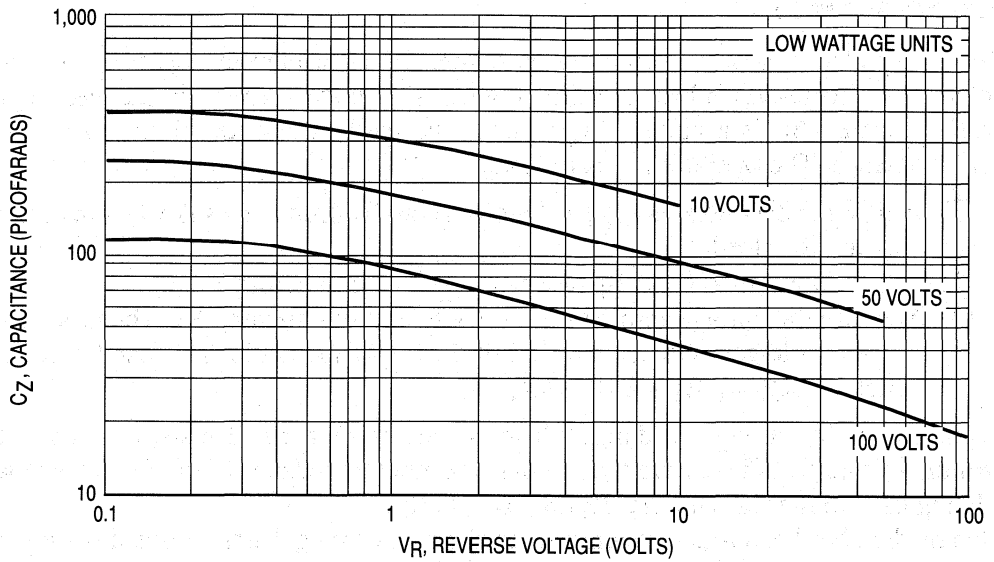

Figure 4-25. Flattening of Capacitance Curve at Low Voltages

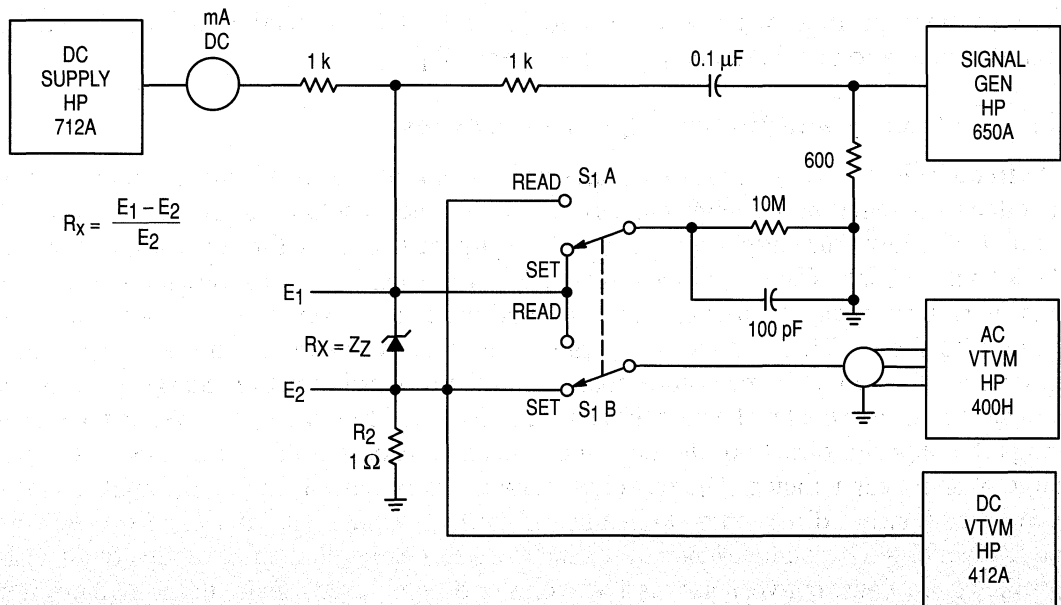

Figure 4-26. Impedance Test Circuit

Zener Impedance

Zener impedance appears primarily as composed of a current-dependent resistance shunted by a voltage-dependent capacitor. Figure 4-26 shows the test circuit used to gather impedance data. This is a voltage-impedance ratio method of determining the unknown zener impedance. The operation is as follows:

- (1) Adjust for desired zener I_{ZDC} by observing IR drop across the 1-ohm current-viewing resistor R_2 .
- (2) Adjust I_{ZAC} to 100 μA by observing AC IR drop across R_2 .
- (3) Measure the voltage across the entire network by switching S_1 . The ratio of these two AC voltages is then a measure of the impedance ratio. This can be expressed simply as $R_X = [(E_1 - E_2)/E_2] R_2$.

Section A of S_1 provides a dummy load consisting of a 10-M resistor and a 100 pF capacitor. This network is required to simulate the input impedance of the AC VTVM while it is being used to measure the AC IR drop across R_2 .

This method has been found accurate up to about three megahertz; above this frequency, lead inductances and strap capacitance become the dominant factors.

Figure 4-27 shows typical impedance versus frequency relationships of 6.8 volt 500 mW zener diodes at various DC zener currents. Before the zener breakdown region is entered, the impedance is almost all reactive, being provided by a voltage-dependent capacitor shunted by a very high resistance. When the zener breakdown region is entered, the capacitance is fixed and now is shunted by current-dependent resistance. For comparison, Figure 4-27 also shows the plot for a 680 pF capacitor X_C , a 1K 1% nonreactive resistor, R , and the parallel combination of these two passive elements, Z_T .

High-Frequency and Switching Considerations

At frequencies about 100 kHz or so and switching speeds above 10 microseconds, shunt capacitance of zener diodes begins to seriously effect their usefulness. The upper photo of Figure 4-28 shows the output waveform of a symmetrical peak limiter using two zener diodes back-to-back. The capacitive effects are obvious here. In any application where the signal is recurrent, the shunt capacitance limitations can be overcome, as lower photo of Figure 4-28 shows. This is done by operating fast diodes in series with the zener. Upon application of a signal, the fast diode conducts in the forward direction charging the shunt zener capacitance to the level where the zener conducts and limits the peak. When the signal swings the opposite direction, the fast diode becomes back-biased and prevents fast discharge of shunt capacitance. The fast diode remains back-biased when the signal reverses again to the forward direction and remains off until the input signal rises and exceeds the charge level of the capacitor. When the signal exceeds this level, the fast diode conducts as does the zener. Thus, between successive cycles or pulses the charge in the shunt capacitor holds off the fast diode, preventing capacitive loading of the signal until zener breakdown is reached. Figures 4-29 and 4-30 show this method applied to fast-pulse peak limiting.

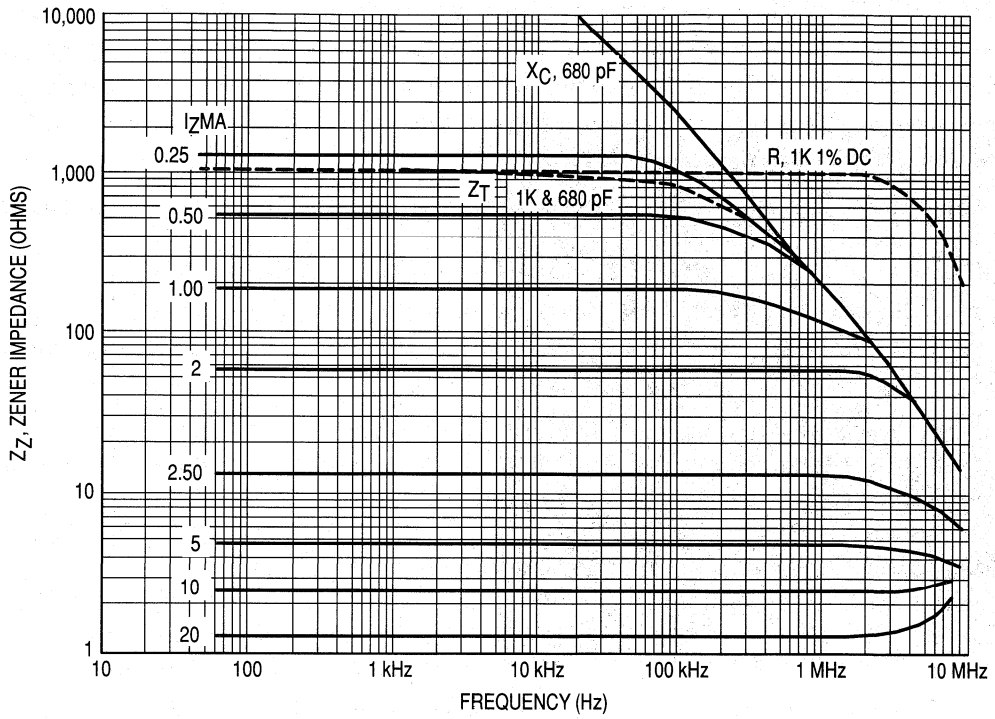

Figure 4-27. Zener Impedance versus Frequency

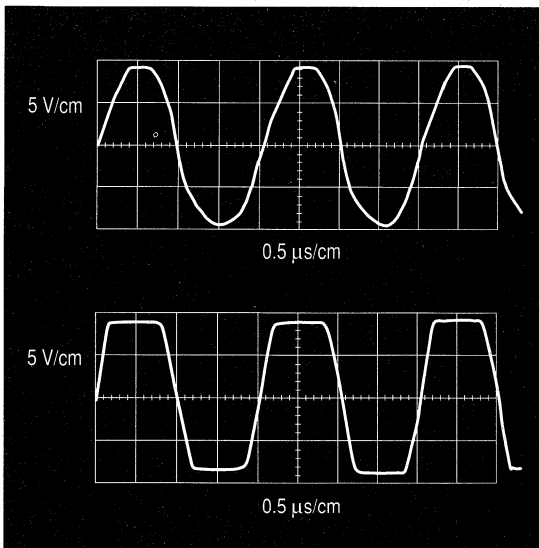

Figure 4-28. Symmetrical Peak Limiter

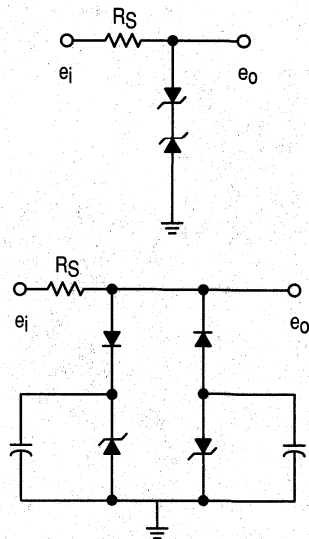

Figure 4-31 is a photo of input-output pulse waveforms using a zener alone as a series peak clipper. The smaller output waveform shows the capacitive spike on the leading edge. Figure 4-32 clearly points out the advantage of the clamping network.

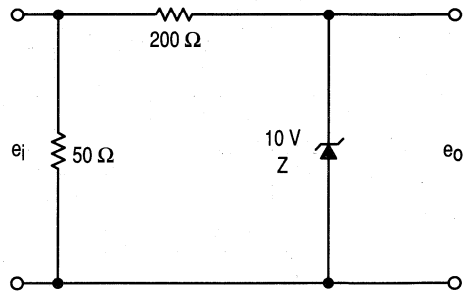
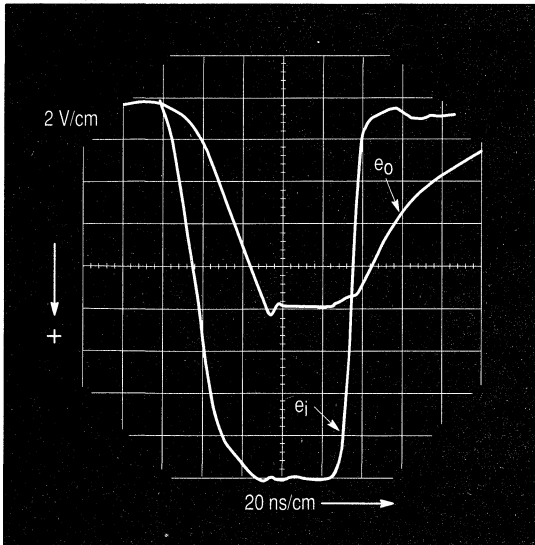

Figure 4-29. Shunt Clipper

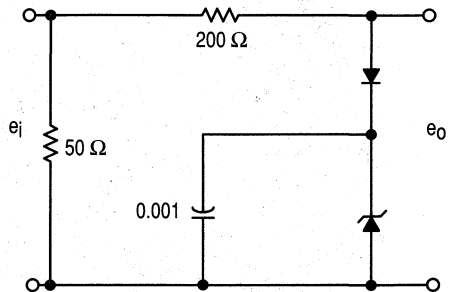
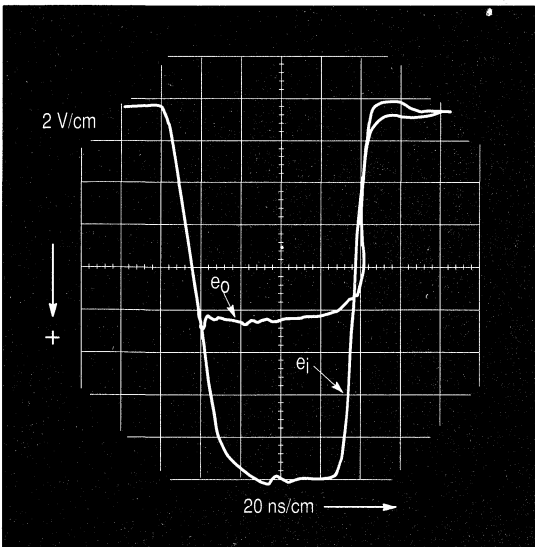

Figure 4-30. Shunt Clipper with Clamping Network

6

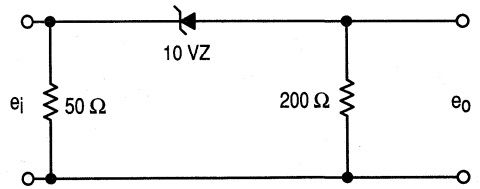
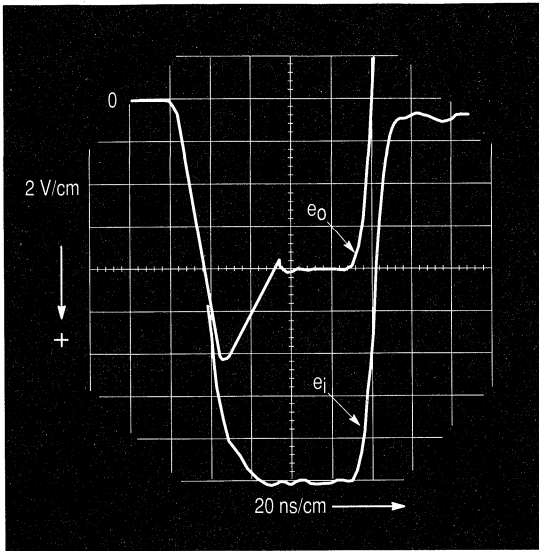

Figure 4-31. Basic Series Clipper

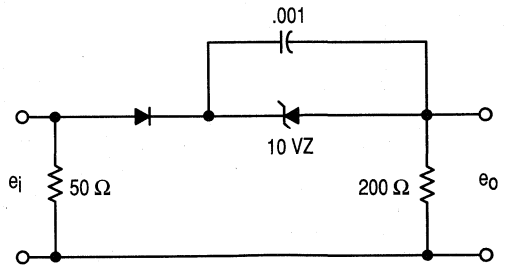
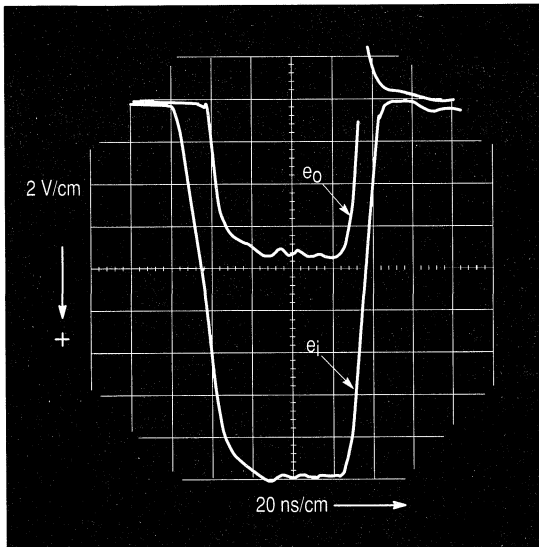

Figure 4-32. Series Clipper with Clamping Network

CHAPTER 5: TEMPERATURE COMPENSATED ZENERS

Introduction

A device which provides reference voltages in a special manner is a reference diode.

As was discussed in the preceding chapters, the zener diode has the unique characteristic of exhibiting either a positive or a negative temperature coefficient, or both. By properly employing this phenomenon in conjunction with other semiconductor devices, it is possible to manufacture a zener reference element exhibiting a very low temperature coefficient when properly used. This type of low temperature coefficient device is referred to as a reference diode.

Introduction to Reference Diodes

The temperature characteristics of the zener diode are discussed in a previous chapter, where it was shown that change in zener voltage with temperature can be significant under severe ambient temperature changes (for example, a 100 V zener can change 12.5 volts from 0 to 125°C). The reference diode (often called the temperature compensated zener or the TC zener) is specially designed to minimize these specific temperature effects.

Design of temperature compensated zeners make possible devices with voltage changes as low as 5 mV from -55 to +100°C, consequently, the advantages of the temperature compensated zener are obvious. In critical applications, as a voltage reference in precision dc power supplies, in high stability oscillators, in digital voltmeters, in frequency meters, in analog-to-digital converters, or in other precision equipment, the temperature compensated zener is a necessity.

Conceivably temperature compensated devices can be designed for any voltage but present devices with optimum voltage temperature characteristics are limited to specific voltages. Each family of temperature compensated zeners is designed by careful selection of its integral parts with special attention to the use conditions (temperature range and current). A distinct operating current is associated with each device. Consequently, changes from the specified operating current can only degrade the voltage-temperature relationships. This will be discussed in more detail later.

The device "drift" or voltage-time stability is critical in some reference applications. Typically zeners and TC zeners offer stability of better than 500 parts per million per 1000 hours.

Temperature Characteristics of the P-N Junction and Compensation

The voltage of a forward biased P-N junction, at a specific current, will decrease with increasing temperature. Thus, a device so biased displays a negative temperature coefficient

(Figure 5-1). A P-N junction in avalanche (above 5 volts breakdown) will display a positive temperature coefficient; that is, voltage will increase as temperature increases. Due to energy levels of a junction which breaks down below 5 volts, the temperature coefficient is negative.

It follows that various combinations of forward biased junctions and reverse biased junctions may be arranged to achieve temperature compensation. From Figure 5-2 it can be seen that if the absolute value of voltage change (ΔV) is the same for both the forward biased diode and the zener diode where the temperature has gone from 25°C to 100°C, then the total voltage across the combination will be the same at both temperatures since one ΔV is negative and the other positive. Furthermore, if the rate of increase (or decrease) is the same throughout the temperature change, voltage will remain constant. The non-linearity associated with the voltage temperature characteristics is a result of this rate of change not being a perfect match.

$$V_{REF} = V_Z + \Delta V_Z + V_D - \Delta V_D$$

The Methods of Temperature Compensation

The effect of temperature is shown in Figure 5-1. The forward characteristic does not vary significantly with reverse voltage breakdown (zener voltage) rating. A change in ambient temperature from 25° to 100°C produces a shift in the forward curve in the direction of lower voltage (a negative temperature coefficient — in this case about 150 mV change), while the same temperature change produces approximately 1.9 V increase in the zener voltage (a positive coefficient). By combining one or more silicon diodes biased in the forward direction with the P-N biased zener diode as shown in Figure 5-3, it is possible to compensate almost completely for the zener temperature coefficient. Obviously, with the example shown, 13 junctions would be needed. Usually reference diodes are low voltage devices, using zeners with 6 to 8 volts breakdown and one or two forward diodes.

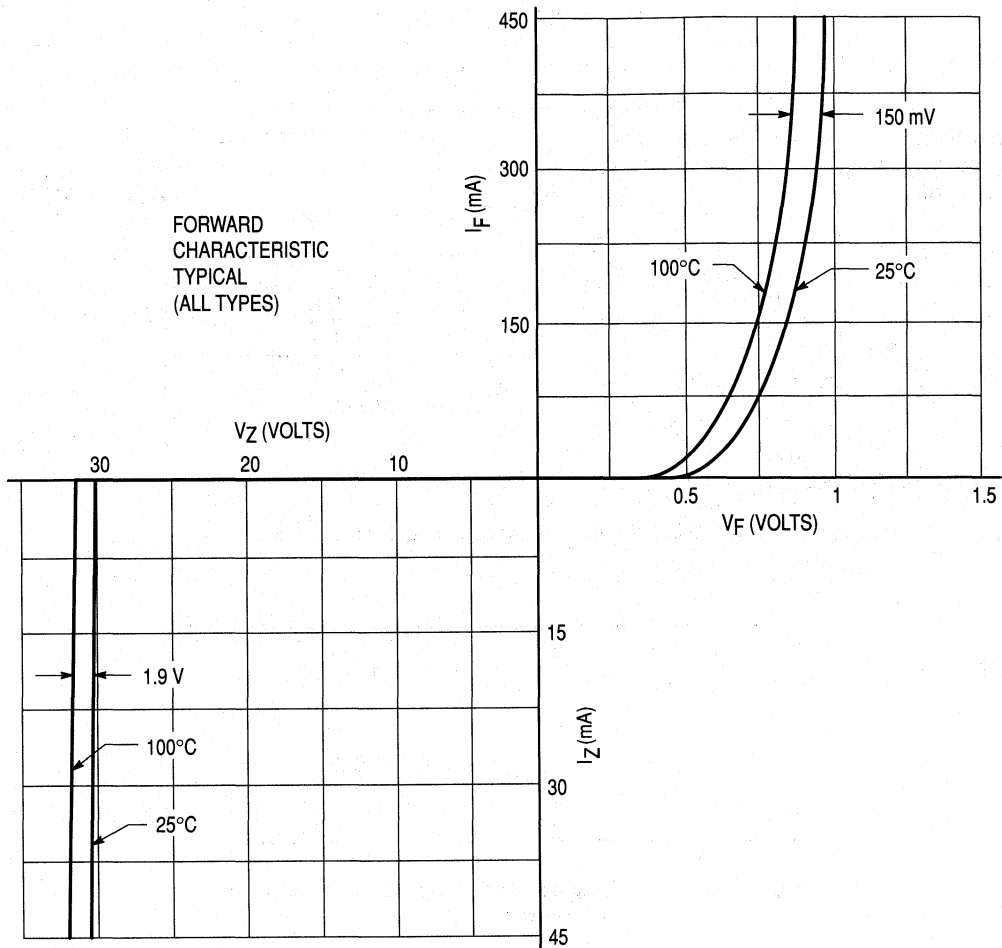

Figure 5-1. Effects of Temperature on Zener Diode Characteristics

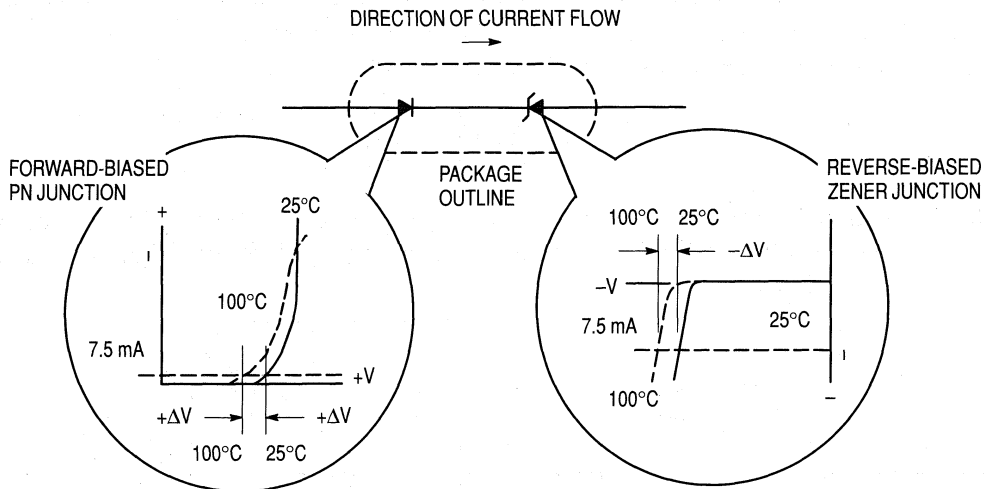

Figure 5-2. Principle of Temperature Compensation

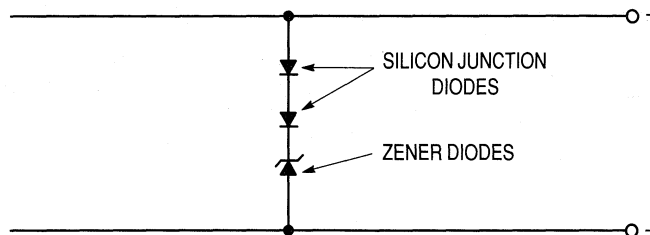

Figure 5-3. Zener Temperature Compensation with Silicon Forward Junctions

6

In ac regulator and clipper circuits where zener diodes are normally connected cathode to cathode, the forward biased diode during each half cycle can be chosen with the correct forward temperature coefficient (by stacking, etc.) to correctly compensate for the temperature coefficient of the reverse-biased zener diode. It is possible to compensate for voltage drift with temperature using this method to the extent that zener voltage stabilities on the order of 0.001%/°C are quite feasible.

This technique is sometimes employed where higher wattage devices are required or where the zener is compensated by the emitter base junction of a transistor stage. Consider the example of using discrete components, 1N4001 rectifier and Motorola 5 Watt zener, to obtain compensated voltage-temperature characteristics. Examination of the curve in Figure 5-4 indicates that a 10 volt zener diode exhibits a temperature coefficient of approximately +5.5 mV/°C. At a current level of 100 mA a temperature coefficient of approximately -2.0 mV/°C is characteristic of the 1N4001 rectifiers. A series connection of three silicon 1N4001 rectifiers produces a total temperature coefficient of approximately -6 mV/°C and a total forward drop of approximately 2.17 volts at 25°C. The combination of three silicon

rectifiers and the 10 volt zener diode produces a device with a coefficient of approximately $-0.5 \text{ mV}/^\circ\text{C}$ and a total breakdown voltage at 100 mA of approximately 12.2 volts. Calculation shows this to be a temperature stability of $-0.004\%/^\circ\text{C}$.

$$\left(\frac{-0.5 \text{ mV}/^\circ\text{C}}{12.2 \text{ V}} \times 100 \right)$$

The temperature-compensated zener employs the technique of specially selected dice. This provides optimum voltage temperature characteristics by close control of dice resistivities.

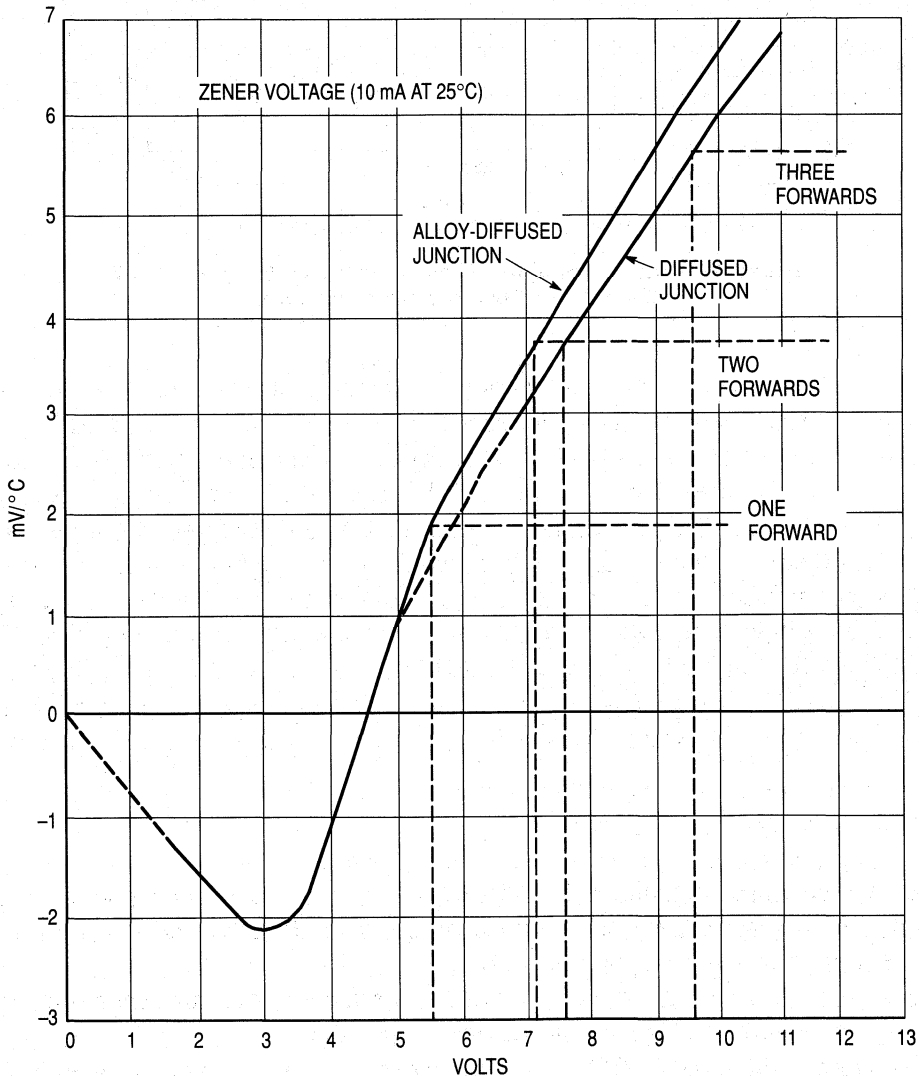

Figure 5-4.

Temperature Coefficient Stability

Figure 5-5 shows the voltage-temperature characteristics of the TC diode. It can be seen that the voltage drops slightly with increasing temperature.

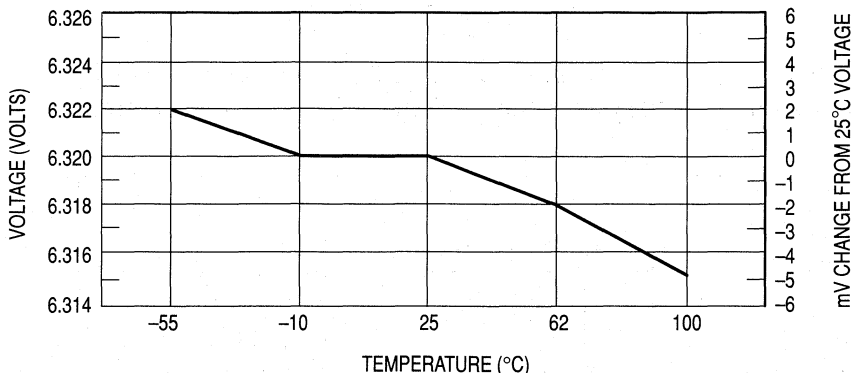

Figure 5-5. Voltage versus Temperature, Typical for Motorola 1N827 Temperature-Compensated Zener Diode

This non-linearity of the voltage temperature characteristic leads to a definition of a representative design parameter ΔV_Z . For each device type there is a specified maximum change allowable. The voltage temperature stability measurement consists of voltage measurement at specified temperatures (for the 1N821 Series the temperatures are -55 , 0 , $+25$, $+75$, and $+100^\circ\text{C}$). The voltage readings at each of the temperatures is compared with readings at the other temperatures and the largest voltage change between any of the specified temperatures determines the exact device type. For devices registered prior to complete definition of the voltage temperature stability measurement, the allowable maximum voltage change over the temperature range is derived from the calculation converting $\%/^\circ\text{C}$ to mV over the temperature range. Under this standard definition, $\%/^\circ\text{C}$ is merely a nomenclature and the meaningful allowable voltage deviation to be expected becomes the designed parameter.

6

Current

Thus far, temperature-compensated zeners have been discussed mainly with regard to temperature and voltage. However, the underlying assumption throughout the previous discussion was that current remained constant.

There is a significant change in the temperature coefficient of a unit depending on how much above or below the test current the device is operated.

A particular unit with a $0.01\%/^\circ\text{C}$ temperature coefficient at 7.5 mA over a temperature range of -55°C to $+100^\circ\text{C}$ could possibly have a $0.0005\%/^\circ\text{C}$ temperature coefficient at 11

mA. In fact, there is a particular current which can be determined for each individual unit that will give the lowest TC.

Manufacturing processes are designed so that the yields of low TC units are high at the test specification for current. A unit with a high TC at the test current can have a low TC at some other current. A look at the volt-ampere curves at different temperatures illustrates this point clearly (see Figure 5-6).

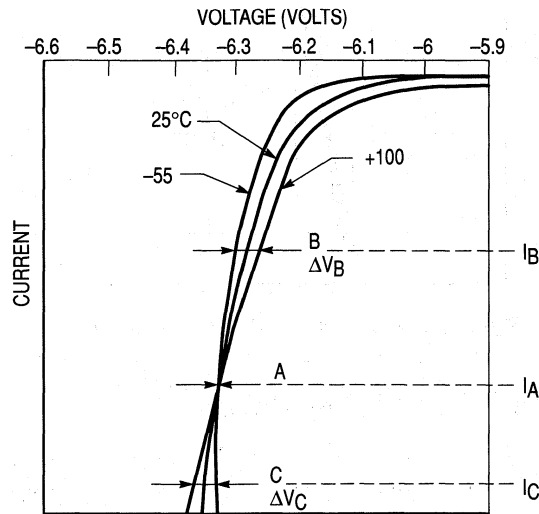

Figure 5-6. Voltage-Ampere Curves Showing Crossover at A

If the three curves intersect at A, then operation at I_A results in the least amount of voltage deviation due to temperature from the $+25^\circ\text{C}$ voltage. At I_B and I_C there are greater excursions (ΔV_B and ΔV_C) from the $+25^\circ\text{C}$ voltage as temperature increases or decreases.

The Effects of Poor Current Regulation

If current shifts (randomly or as a function of temperature), then an area of operation can be defined for the temperature-compensated zener.

Once again the curves are drawn, this time a shaded area is shown on the graph. The upper and lower extremities denote the maximum current values generated by the current supply while the voltage extremes at each current are shown by the left and right sides of the area, shown in Figure 5-7.

The three volt-ampere curves do not usually cross over at exactly the same point. However, this does not take away from the argument that current regulation is probably the most critical consideration when using temperature-compensated units.

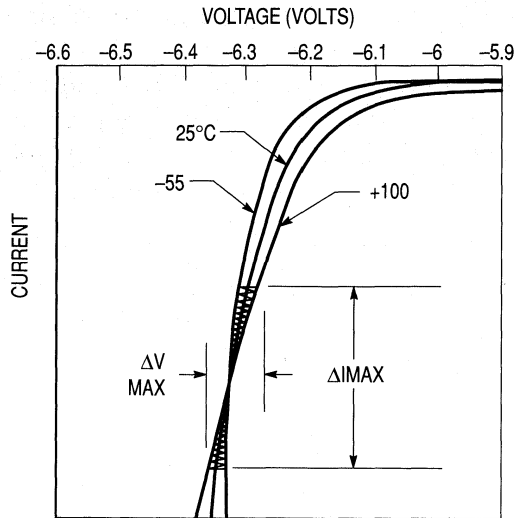

Figure 5-7. Effects of Poorly Regulated Current

Zener Impedance and Current Regulation

Zener impedance is defined as the slope of the V-I curve at the test point corresponding to the test current. It is measured by superimposing a small ac current on the dc test current and then measuring the resulting ac voltage. This procedure is identical with that used for regular zeners.

Impedance changes with temperature, but the variation is usually small and it can be assumed that the amount of current regulation needed at +25°C will be the same for other temperatures.

As an example, one might want to determine the amount of current regulation necessary for the device described below when the maximum deviation in voltage due to current variation is ± 5 millivolts.

6

$$V_{ZT} = 6.32 \text{ V}$$

$$I_{ZT} = 7.5 \text{ mA}$$

$$Z_{ZT} = 15 \ \Omega \ @ \ +25^\circ\text{C}$$

$$\Delta V = \Delta I \cdot Z_{ZT}$$

$$0.005 = \Delta I \cdot 15$$

$$\Delta I = \frac{0.005}{15} = 0.33 \text{ mA}$$

Therefore, the current cannot vary more than 0.33 mA.

The amount of current regulation necessary is:

$$\frac{0.33}{7.5} \times 100\% = 4.5\% \text{ regulation.}$$

If the device of Figure 5-5 is considered to be the device used in the preceding discussion, it becomes apparent that on the average more voltage variation is due to current fluctuation than is due to temperature variation. Therefore, to obtain a truly stable reference source, the device must be driven from a constant current source.

CHAPTER 6: BASIC VOLTAGE REGULATION USING ZENER DIODES

Basic Concepts of Regulation

The purpose of any regulator circuit is to minimize output variations with respect to variations in input, temperature, and load requirements. The most obvious use of a regulator is in the design of a power supply, but any circuit that incorporates regulatory technique to give a controlled output or function can be considered as a regulator. In general, to provide a regulated output voltage, electronic circuitry will be used to pass an output voltage that is significantly lower than the input voltage and block all voltage in excess of the desired output. Allocations should also be made in the regulation circuitry to maintain this output voltage for variation in load current demand.

There are some basic rules of thumb for the electrical requirements of the electronic circuitry in order for it to provide regulation. Number one, the output impedance should be kept as low as possible. Number two, a controlling reference needs to be established that is relatively insensitive to the prevailing variables. In order to illustrate the importance of these rules, an analysis of some simple regulator circuits will point out the validity of the statements. The circuit of Figure 6-1 can be considered a regulator. This circuit will serve to illustrate the importance of a low output impedance.

The resistors R_S and R_R can be considered as the source and regulator impedances, respectively.

The output of the circuit is:

$$V_O = V_I \times \frac{R_R R_L}{R_R + R_L} \bigg/ \left(R_S + \frac{R_R R_L}{R_R + R_L} \right) = \frac{V_I}{\frac{R_S}{R_L} + \frac{R_S}{R_R} + 1} \quad (6-1)$$

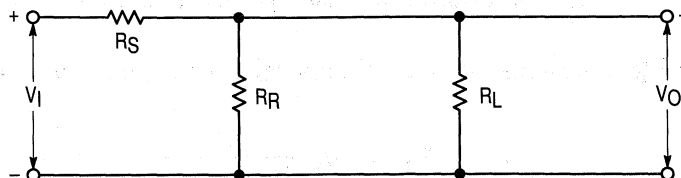

Figure 6-1. Shunt Resistance Regulator

For a given incremental change in V_I , the changes in V_O will be

$$\Delta V_O = \Delta V_I \left(\frac{1}{\frac{R_S}{R_L} + \frac{R_S}{R_R} + 1} \right) \quad (6-2)$$

Assuming R_L fixed at some constant value, it is obvious from equation (6-2) that in order to minimize changes in V_O for variations in V_I , the shunt resistor R_R should be made as small as possible with respect to the source resistor R_S . Obviously, the better this relation becomes, the larger V_I is going to have to be for the same V_O , and not until the ratio of R_S to R_R reaches infinity will the output be held entirely constant for variation in V_I . This, of course, is an impossibility, but it does stress the fact that the regulation improves as the output impedance becomes lower and lower. Where the output impedance of Figure 6-1 is given by

$$R_O = \frac{R_S R_R}{R_S + R_R} \quad (6-3)$$

It is apparent from this relation that as regulation is improving with R_S increasing and R_R decreasing the output impedance R_O is decreasing, and is approximately equal to R_R as the ratio is 10 times or greater. The regulation of this circuit can be greatly improved by inserting a reference source of voltage in series with R_R such as Figure 6-2.

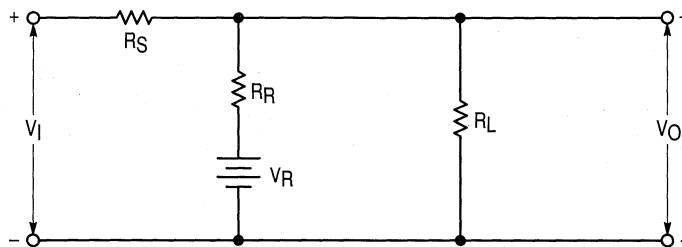

Figure 6-2. Regulator with Battery Reference Source

The resistance R_R represents the internal impedance of the battery. For this circuit, the output is

$$V_O = V_R + V_I \frac{V}{\frac{R_S}{R_L} + \frac{R_S}{R_R} + 1} \quad (6-4)$$

Then for incremental changes in the input V_I , the changes in V_O will be dependent on the second term of equation (6-4), which again makes the regulation dependent on the ratio of R_S to R_R . Where changes in the output voltage or the regulation of the circuit in Figure 6-1 were directly and solely dependent upon the input voltage and output impedance, the regulation of circuit 6-2 will have an output that varies about the reference source V_R in accordance

with the magnitude of battery resistance R_R and its fluctuations for changes in V_I . Theoretically, if a perfect battery were used, that is, V_R is constant and R_R is zero, the circuit would be a perfect regulator. In other words, in line with the basic rules of thumb the circuit exhibits optimum regulation with an output impedance of zero, and a constant reference source.

For regulator application, a zener diode can be used instead of a battery with a number of advantages. A battery's resistance and nominal voltage will change with age and load demand; the Motorola zener diode characteristics remain unchanged when operating within its specified limits. Any voltage value from a couple of volts to hundreds of volts is available with zener diodes, where conventional batteries are limited in the nominal values available. Also, the zener presents a definite size advantage, and is less expensive than a battery because it is permanent and need not be regularly replaced. The basic zener diode shunt regulator circuit is shown in Figure 6-3.

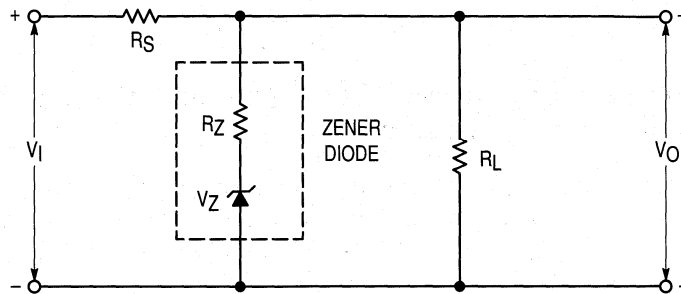

Figure 6-3. Basic Zener Diode Shunt Regulator

Depending upon the operating conditions of the device, a zener diode will exhibit some relatively low zener impedance R_Z and have a specified breakover voltage of V_Z that is essentially constant. These inherent characteristics make the zener diode suited for voltage regulator applications.

Designing the Zener Shunt Regulator

For any given application of a zener diode shunt regulator, it will be required to know the input voltage variations and output load requirements. The calculation of component values will be directly dependent upon the circuit requirements. The input may be constant or have maximum and minimum values depending upon the natural regulation or waveform of the supply source. The output voltage will be determined by the designer's choice of V_Z and the circuit requirements. The actual value of V_Z will be dependent upon the manufacturer's tolerance and some small variation for different zener currents and operating temperatures.

For all practical purposes, the value of V_Z as specified on the manufacturer's data sheet can be used to approximate V_O in computing component values. The requirement for load current will be known and will vary within some given range of $I_L(\min)$ to $I_L(\max)$.

The design objective of Figure 6-3 is to determine the proper values of the series resistance, R_S , and zener power dissipation, P_Z . A general solution for these values can be developed as follows, when the following conditions are known:

V_I (input voltage) from $V_{I(\min)}$ to $V_{I(\max)}$

V_O (output voltage) from $V_{Z(\min)}$ to $V_{Z(\max)}$

I_L (load current) from $I_{L(\min)}$ to $I_{L(\max)}$

The value of R_S must be of such a value so that the zener current will not drop below a minimum value of $I_{Z(\min)}$. This minimum zener current is mandatory to keep the device in the breakover region in order to maintain the zener voltage reference. The minimum current can be either chosen at some point beyond the knee or found on the manufacturer's data sheet (I_{ZK}). The basic voltage loop equation for this circuit is:

$$V_I = (I_Z + I_L)R_S + V_Z \quad (6-5)$$

The minimum zener current will occur when V_I is minimum, V_Z is maximum, and I_L is maximum, then solving for R_S , we have:

$$R_S = \frac{V_{I(\min)} - V_{Z(\max)}}{I_{Z(\min)} + I_{L(\max)}} \quad (6-6)$$

Having found R_S , we can determine the maximum power dissipation P_Z for the zener diode.

$$P_{Z(\max)} = I_{Z(\max)} V_{Z(\max)} \quad (6-7)$$

Where:

$$I_{Z(\max)} = \frac{V_{I(\max)} - V_{Z(\min)}}{R_S} - I_{L(\min)} \quad (6-8)$$

6

Therefore:

$$P_{Z(\max)} = \left[\frac{V_{I(\max)} - V_{Z(\min)}}{R_S} - I_{L(\min)} \right] V_{Z(\max)} \quad (6-9)$$

Once the basic regulator components values have been determined, adequate considerations will have to be given to the variation in V_O . The changes in V_O are a function of four different factors; namely, changes in V_I , I_L , temperature, and the value of zener impedance, R_Z . These changes in V_O can be expressed as:

$$\Delta V_O = \frac{\Delta V_I}{1 + \frac{R_S}{R_Z} + \frac{R_S}{R_L}} - \frac{R_S R_Z}{R_S + R_Z} \Delta I_L + T_C \Delta T V_Z \quad (6-10)$$

The value of ΔV_O as calculated with equation (6-10) will quite probably be slightly different from the actual value when measured empirically. For all practical purposes though, this difference will be insignificant for regulator designs utilizing the conventional commercial line of zener diodes.

Obviously to precisely predict ΔV_O with a given zener diode, exact information would be needed about the zener impedance and temperature coefficient throughout the variation of zener current. The “worst case” change can only be approximated by using maximum zener impedance and with typical temperature coefficient.

The basic zener shunt regulator can be modified to minimize the effects of each term in the regulation equation (6-10). Taking one term at a time, it is apparent that the regulation or changes in output ΔV_O will be improved if the magnitude of ΔV_I is reduced. A practical and widely used technique to reduce input variation is to cascade zener shunt regulators such as shown in Figure 6-4.

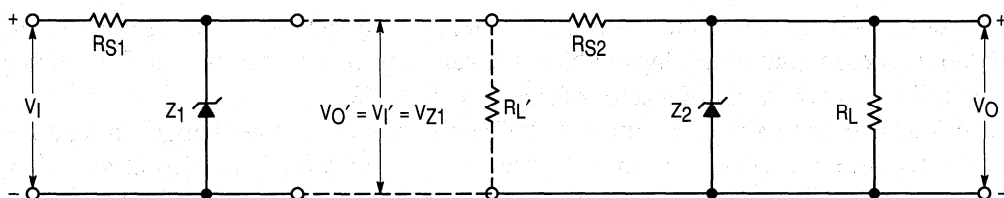

Figure 6-4. Cascaded Zener Shunt Regulators Reduce ΔV_O by Reducing ΔV_I to the Succeeding Stages

This, in essence, is a regulator driven with a pre-regulator so that the over all regulation is the product of both. The regulation or changes in output voltage is determined by:

$$\Delta V_O = \frac{\Delta V_{Z1}}{1 + \frac{R_{S2}}{R_L} + \frac{R_{S2}}{R_{Z2}}} - \frac{R_{S2}R_{Z2}}{R_{S2} + R_{Z2}} \Delta I_L + TC_2 \Delta TV_{Z2} \quad (6-11)$$

Where:

$$\Delta V_{Z1} = \Delta V_{O'} = \frac{\Delta V_I}{1 + \frac{R_{S1}}{R_{L'}} + \frac{R_{S1}}{R_{Z1}}} - \frac{R_{S1}R_{Z1}}{R_{S1} + R_{Z1}} \Delta I_{L'} + TC_1 \Delta TV_{Z1} \quad (6-12)$$

$$R_{L'} = R_{S2} + \frac{R_L R_{Z2}}{R_L + R_{Z2}} \text{ and } I_{L'} = I_L + I_{Z2}$$

The changes in output with respect to changes in input for both stages assuming the temperature and load are constant is

$$\frac{\Delta V_O}{\Delta V_{Z1}} = \frac{\Delta V_O}{\Delta V_O'} = \text{Regulation of second stage} \quad (6-13)$$

$$\frac{\Delta V_O'}{\Delta V_I} = \text{Regulation of first stage} \quad (6-14)$$

$$\frac{\Delta V_O}{\Delta V_I} = \frac{\Delta V_O}{\Delta V_O'} \times \frac{\Delta V_O'}{\Delta V_I} = \text{Combined regulation} \quad (6-15)$$

Obviously, this technique will vastly improve overall regulation where the input fluctuates over a relatively wide range. As an example, let's say the input varies by $\pm 20\%$ and the regulation of each individual stage reduces the variation by a factor of $1/20$. This then gives an overall output variation of $\pm 20\% \times (1/20)^2$ or $\pm 0.05\%$.

The next two factors in equation (6-10) affecting regulation are changes in load current and temperature excursions. In order to minimize changes for load current variation, the output impedance $R_Z R_S / (R_Z + R_S)$ will have to be reduced. This can only be done by having a lower zener impedance because the value of R_S is fixed by circuit requirements. There are basically two ways that a lower zener impedance can be achieved. One, a higher wattage device can be used which allows for an increase in zener current of which will reduce the impedance. The other technique is to series lower voltage devices to obtain the desired equivalent voltage, so that the sum of the impedance is less than that for a single high voltage device. So to speak, this technique will kill two birds with one stone, as it can also be used to minimize temperature induced variations of the regulator.

In most regulator applications, the single most detrimental factor affecting regulation is that of variation in junction temperature. The junction temperature is a function of both the ambient temperature and that of self heating. In order to illustrate how the overall temperature coefficient is improved with series lower voltage zener, a mathematical relationship can be developed. Consider the diagram of Figure 6-5.

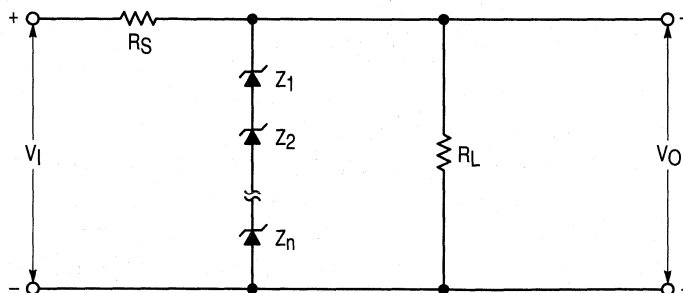

Figure 6-5. Series Zener Improve Dynamic Impedance and Temperature Coefficient

With the temperature coefficient TC defined as the % change per °C, the change in output for a given temperature range will equal some overall TC × ΔT × Total VZ. Such as

$$\Delta V_O(\Delta T) = TC \Delta T (V_{Z1} + V_{Z2} + \dots + V_{ZN}) \quad (6-16)$$

Obviously, the change in output will also be equal to the sum of the changes as attributed from each zener.

$$\Delta V_O(\Delta T) = \Delta T(TC_1 V_{Z1} + TC_2 V_{Z2} + \dots + TC_N V_{ZN}) \quad (6-17)$$

Setting the two equations equal to each other and solving for the overall TC, we get

$$TC \Delta T (V_{Z1} + V_{Z2} + \dots + V_{ZN}) = \Delta T (TC_1 V_{Z1} + TC_2 V_{Z2} + \dots + TC_N V_{ZN}) \quad (6-18)$$

$$TC = \frac{TC_1 V_{Z1} + TC_2 V_{Z2} + \dots + TC_N V_{ZN}}{V_{Z1} + V_{Z2} + \dots + V_{ZN}} \quad (6-19)$$

For equation (6-19) the overall temperature coefficient for any combination of series zeners can be calculated. Say for instance several identical zeners in series replace a single higher voltage zener. The new overall temperature coefficient will now be that of one of the low voltage devices. This allows the designer to go to the manufacturer's data sheet and select a combination of low TC zener diodes in place of the single higher TC devices. Generally speaking, the technique of using multiple devices will also yield a lower dynamic impedance. Advantages of this technique are best demonstrated by example. Consider a 5 watt diode with a nominal zener voltage of 10 volts exhibits approximately 0.055% change in voltage per degree centigrade, a 20 volt unit approximately 0.075%/°C, and a 100 volt unit approximately 0.1%/°C. In the case of the 100 volt diode, five 20 volt diodes could be connected together to provide the correct voltage reference, but the overall temperature coefficient would remain that of the low voltage units, i.e. 0.075%/°C. It should also be noted that the same series combination improves the overall zener impedance in addition to the temperature coefficient. A 20 volt, 5 watt Motorola zener diode has a maximum zener impedance of 3 ohms, compared to the 90 ohms impedance which is maximum for a 100 volt unit. Although these impedances are measured at different current levels, the series impedance of five 20 volt zener diodes is still much lower than that of a single 100 volt zener diode at the test current specified on the data sheet.

For the ultimate in zener shunt regulator performance, the aforementioned techniques can be combined with the proper selection of devices to yield an overall improvement in regulation. For instance, a multiple string of low voltage zener diodes can be used as a preregulator, with a series combination of zero TC reference diodes in the final stage such as Figure 6-6.

The first stage will reduce the large variation in V_I to some relatively low level, i.e. ΔV_Z . This ΔV_Z is optimized by utilizing a series combination of zeners to reduce the overall TC

and ΔV_Z . Because of this small fluctuation of input to the second stage, and if R_L is constant, the biasing current of the TC units can be maintained at their specified level. This will give an output that is very precise and not significantly affected by changes in input voltage or junction temperature.

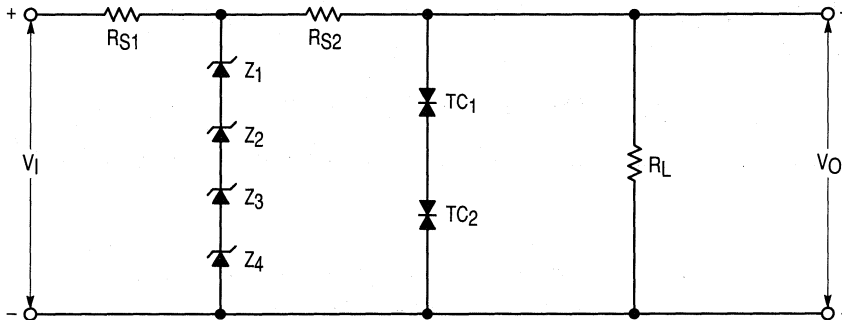

Figure 6-6. Series Zeners Cascaded With Series Reference Diodes for Improved Zener Shunt Regulation

The basic zener shunt regulator exhibits some inherent limitations to the designer. First of all, the zener is limited to its particular power dissipating rating which may be less than the required amount for a particular situation. The total magnitude of dissipation can be increased to some degree by utilizing series or parallel units. Zeners in series present few problems because individual voltages are additive and the devices all carry the same current and the extent that this technique can be used is only restricted by the feasibility of circuit parameters and cost. On the other hand, caution must be taken when attempting to parallel zener diodes. If the devices are not closely matched so that they all break over at the same voltage, the low voltage device will go into conduction first and ultimately carry all the current. In order to avoid this situation, the diodes should be matched for equal current sharing.

6

Extending Power and Current Range

The most common practice for extending the power handling capabilities of a regulator is to incorporate transistors in the design. This technique is discussed in detail in the following sections of this chapter. The second disadvantage to the basic zener shunt regulator is that because the device does not have a gain function, a feedback system is not possible with just the zener resistor combination. For very precise regulators, the design will normally be an electronic circuit consisting of transistor devices for control, probably a closed loop feedback system with a zener device as the basic referencing element.

The concept of regulation can be further extended and improved with the addition of transistors as the power absorbing elements to the zener diodes establishing a reference. There are three basic techniques used that combine zener diodes and transistors for voltage regulation. The shunt transistor type shown in Figure 6-7 will extend the power handling capabilities of the basic shunt regulator, and exhibit marked improvement in regulation.

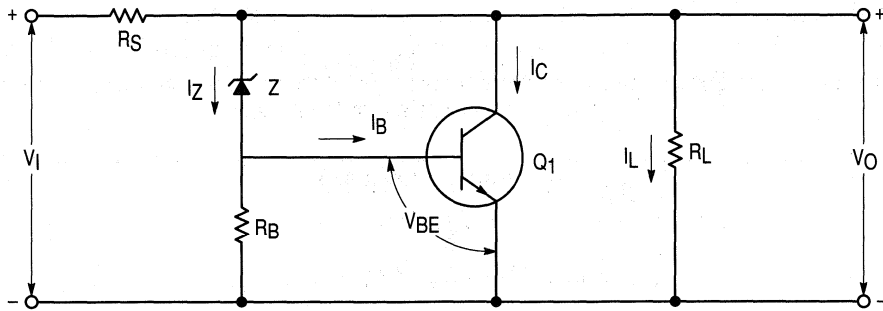

Figure 6-7. Basic Transistor Shunt Regulator

In this configuration the source resistance must be large enough to absorb the overvoltage in the same manner as in the conventional zener shunt regulator. Most of the shunt regulating current in this circuit will pass through the transistor reducing the current requirements of the zener diode by essentially the dc current gain of the transistor h_{FE} . Where the total regulating shunt current is:

$$I_S = I_Z + I_C = I_Z + I_B h_{FE}$$

where

$$I_Z = I_B + I_{RB} \text{ and } I_B \gg I_{RB}$$

therefore

$$I_S \approx I_Z + I_Z h_{FE} = I_Z (1 + h_{FE}) \quad (6-20)$$

The output voltage is the reference voltage V_Z plus the forward junction drop from base to emitter V_{BE} of the transistor.

$$V_O = V_Z + V_{BE} \quad (6-21)$$

The values of components and their operating condition is dictated by the specific input and output requirements and the characteristics of the designer's chosen devices, as shown in the following relations:

$$R_S = \frac{V_{I(\min)} - V_{O(\max)}}{I_{Z(\min)} [1 + h_{FE(\min)}] + I_{L(\max)}} \quad (6-22)$$

$$R_B = \frac{V_{I(\min)} - V_{Z(\max)}}{I_{Z(\min)}} \quad (6-23)$$

$$PDZ = I_{Z(\max)} V_{Z(\max)} \quad (6-24)$$

when

$$I_{Z(\max)} = \left[\frac{V_{I(\max)} - V_{O(\min)}}{R_S} - I_{L(\min)} \right] \left(\frac{1}{1 + h_{FE(\min)}} \right) \quad (6-25)$$

hence

$$PDZ = \left[\frac{V_{I(\max)} - V_{O(\min)}}{R_S} - I_{L(\min)} \right] \left(\frac{V_{Z(\max)}}{1 + h_{FE(\min)}} \right) \quad (6-26)$$

$$PDQ = \left[\frac{V_{I(\max)} - V_{O(\min)}}{R_S} - I_{L(\min)} \right] (V_{O(\max)}) \quad (6-27)$$

Regulation with this circuit is derived in essentially the same manner as in the shunt zener circuit, where the output impedance is low and the output voltage is a function of the reference voltage. The regulation is improved with this configuration because the small signal output impedance is reduced by the gain of Q1 by $1/h_{FE}$.

6

One other highly desirable feature of this type of regulator is that the output is somewhat self compensating for temperature changes by the opposing changes in V_Z and V_{BE} for $V_Z \approx 10$ volts. With the zener having a positive $2 \text{ mV}/^\circ\text{C}$ TC and the transistor base to emitter being a negative $2 \text{ mV}/^\circ\text{C}$ TC, therefore, a change in one is cancelled by the change in the other. Even though this circuit is a very effective regulator it is somewhat undesirable from an efficiency standpoint. Because the magnitude of R_S is required to be large, and it must carry the entire input current, a large percentage of power is lost from input to output.

Emitter Follower Regulator

Another basic technique of transistor-zener regulation is that of the emitter follower type shown in Figure 6-8.

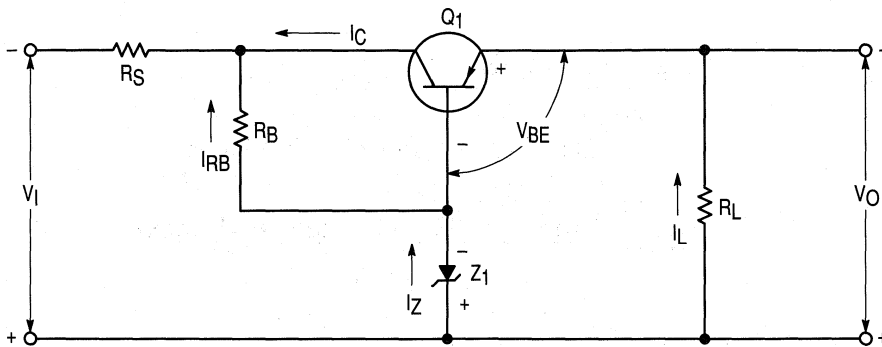

Figure 6-8. Emitter Follower Regulator

This circuit has the desirable feature of using a series transistor to absorb overvoltages instead of a large fixed resistor, thereby giving a significant improvement in efficiency over the shunt type regulator. The transistor must be capable of carrying the entire load current and withstanding voltages equal to the input voltage minus the load voltage. This, of course, imposes a much more stringent power handling requirement upon the transistor than was required in the shunt regulator. The output voltage is a function of the zener reference voltage and the base to emitter drop of Q_1 as expressed by the equation (6-28).

$$V_O = V_Z - V_{BE} \quad (6-28)$$

The load current is approximately equal to the transistor collector current, such as shown in equation (6-29).

$$I_L(\max) \approx I_C(\max) \quad (6-29)$$

The designer must select a transistor that will meet the following basic requirements:

$$P_D \approx (V_I(\max) - V_O)I_L(\max)$$

$$I_C(\max) \approx I_L(\max)$$

$$BV_{CES} \geq (V_I(\max) - V_O) \quad (6-30)$$

Depending upon the designer's choice of a transistor and the imposed circuit requirements, the operation conditions of the circuit are expressed by the following equations:

$$\begin{aligned}
 V_Z &= V_O + V_{BE} \\
 &= V_O + I_{L(\max)}/g_{FE(\min)} @ I_{L(\max)} \\
 R_S &= \frac{V_{I(\min)} - V_Z - V_{CE(\min)} @ I_{L(\max)}}{I_{L(\max)}} \quad (6-31)
 \end{aligned}$$

Where $V_{CE(\min)}$ is an arbitrary value of minimum collector to emitter voltage and g_{FE} is the transconductance.

This is sufficient to keep the transistor out of saturation, which is usually about 2 volts.

$$R_B = \frac{V_{CE(\min)} @ I_{L(\max)}}{I_{L(\max)}/h_{FE(\min)} @ I_{L(\max)} + I_{Z(\min)}} \quad (6-32)$$

$$I_{Z(\max)} = \frac{V_{I(\max)} - V_Z}{R_B + R_Z} \quad (6-33)$$

$$PD_Z = I_{Z(\max)} V_Z \quad (6-34)$$

$$\text{Actual PDQ} = (V_{I(\max)} - V_O) I_{L(\max)} \quad (6-35)$$

6 There are two primary factors that effect the regulation most in a circuit of this type. First of all, the zener current may vary over a considerable range as the input changes from minimum to maximum and this, of course, may have a significant effect on the value of V_Z and therefore V_O . Secondly, V_Z and V_{BE} will both be effected by temperature changes which are additive on their effect of output voltage. This can be seen by altering equation (6-28) to show changes in V_O as dependent on temperature, see equation (6-36).

$$V_O(\Delta T) = \Delta T[(+TC) V_Z - (-TC) V_{BE}] \quad (6-36)$$

The effects of these detrimental factors can be minimized by replacing the bleeder resistor R_B with a constant current source and the zener with a reference diode in series with a forward biased diode (see Figure 6-9).

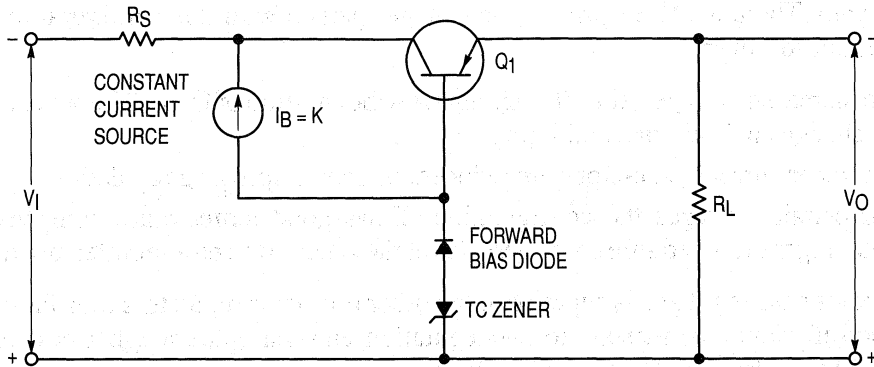

Figure 6-9. Improved Emitter Follower Regulator

The constant current source can be either a current limiter diode or a transistor source. The current limiter diode is ideally suited for applications of this type, because it will supply the same biasing current irregardless of collector to base voltage swing as long as it is within the voltage limits of the device. This technique will overcome changes in V_Z for changes in I_Z and temperature, but changes in V_{BE} due to load current changes are still directly reflected upon the output. This can be reduced somewhat by combining a transistor with the zener for the shunt control element as illustrated in Figure 6-10.

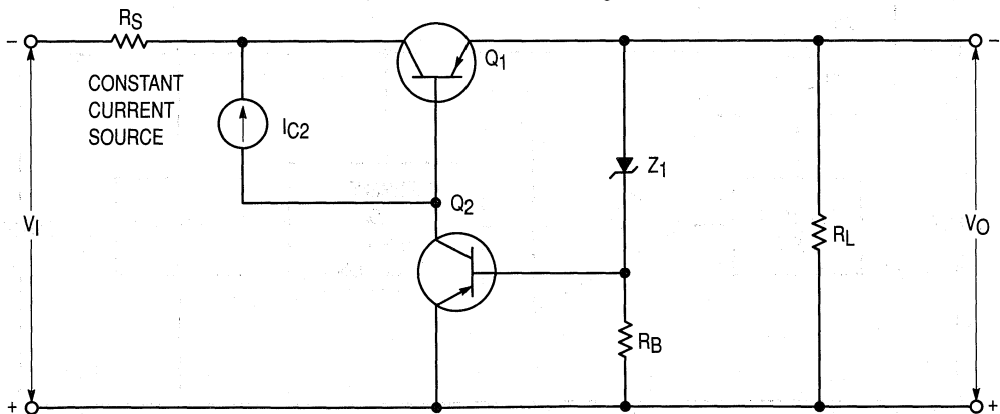

Figure 6-10. Series Pass Regulator

This is the third basic technique used for transistor-zener regulators. This technique or at least a variation of it, finds the widest use in practical applications. In this circuit the transistor Q_1 is still the series control device operating as an emitter follower. The output voltage is now established by the transistor Q_2 base to emitter voltage and the zener voltage. Because the zener is only supplying base drive to Q_2 , and it derives its bias from the output, the zener current remains essential constant, which minimizes changes in V_Z due to I_Z excursions. Also, it may be possible ($V_Z \approx 10\text{ V}$) to match the zener to the base-emitter junction of Q_2 for an output that is insensitive to temperature changes. The constant current source looks like a very high load impedance to the collector of Q_2 thus assuming a very high

voltage gain. There are three primary advantages gained with this configuration over the basic emitter follower:

1. The increased voltage gain of the circuit with the addition of Q_2 will improve regulation for changes in both load and input.
2. The zener current excursions are reduced, thereby improving regulation.
3. For certain voltages the configuration allows good temperature compensation by matching the temperature characteristics of the zener to the base-emitter junction of Q_2 .

The series pass regulator is superior to the other transistor regulators thus far discussed. It has good efficiency, better stability and regulation, and is simple enough to be economical-ly practical for a large percentage of applications.

Employing Feedback for Optimum Regulation

The regulators discussed thus far do not employ any feedback techniques for precise control and compensation and, therefore, find limited use where an ultra precise regulator is required. In the more sophisticated regulators some form of error detection is incorporated and amplified through a feedback network to closely control the power elements as illustrated in the block diagram of Figure 6-11.

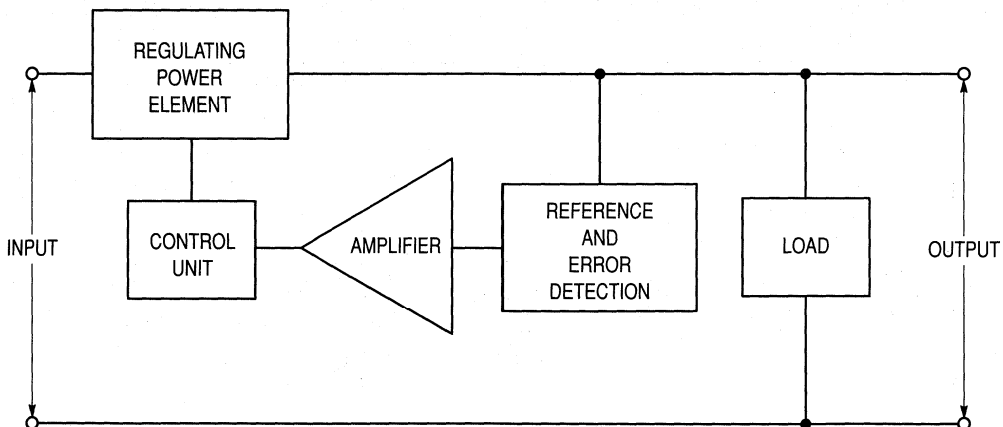

Figure 6-11. Block Diagram of Regulator with Feedback

Regulating circuits of this type will vary in complexity and configuration from application to application. This technique can best be illustrated with a couple of actual circuits of this type. The feedback regulators will generally be some form of series pass regulator, for optimum performance and efficiency. A practical circuit of this type that is extensively utilized is shown in Figure 6-12.

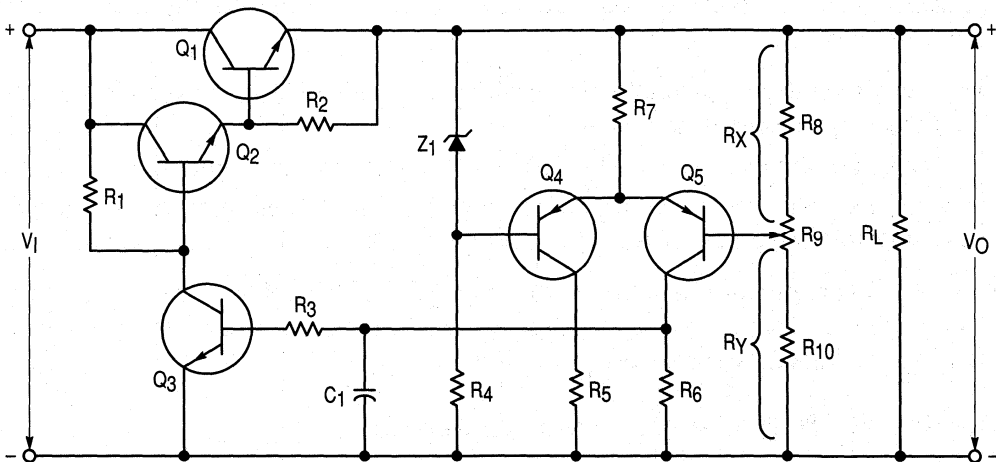

Figure 6-12. Series Pass Regulator with Error Detection and Feedback Amplification Derived from a Differential Amplifier

In this circuit, the zener establishes a reference level for the differential amplifier composed of Q4 and Q5 which will set the base drive for the control transistor Q3 to regulate the series high gain transistor combination of Q1 and Q2. The differential amplifier samples the output at the voltage dividing network of R8, R9, and R10. This is compared to the reference voltage provided by the zener Z1. The difference, if any, is amplified and fed back to the control elements. By adjusting the potentiometer, R9, the output level can be set to any desired value within the range of the supply. (The output voltage is set by the relation $V_O = V_Z[(R_X + R_Y)/R_X]$.) By matching the transistor Q4 and Q5 for variations in V_{BE} and gain with temperature changes and incorporating a temperature compensated diode as the reference, the circuit will be ultra stable to temperature effects. The regulation and stability of this circuit is very good, and for this reason is used in a large percentage of commercial power supplies.

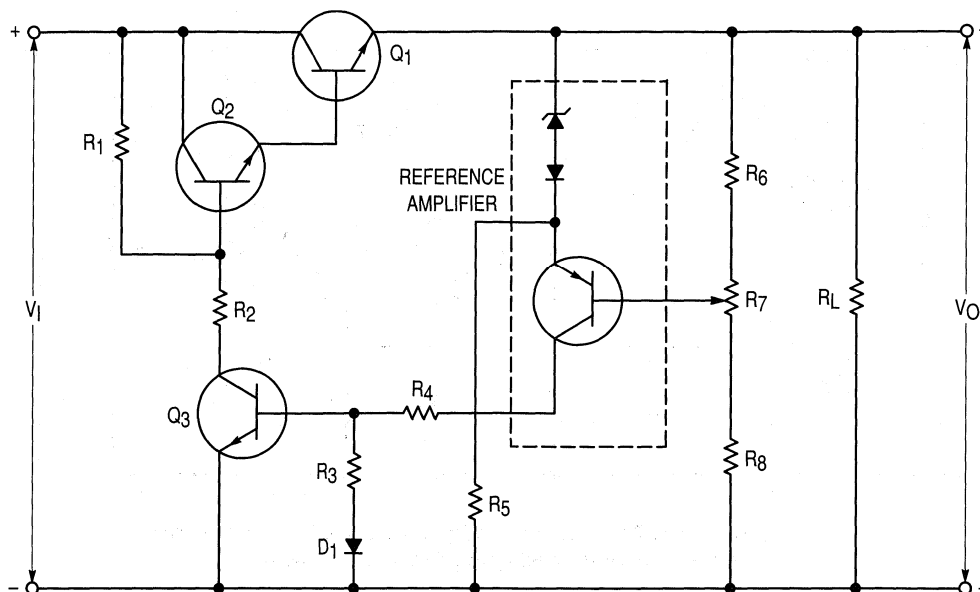

Figure 6-13. Series Pass Regulator with Temperature Compensated Reference Amplifier

Another variation of the feedback series pass regulator is shown in Figure 6-13. This circuit incorporates a stable temperature compensated reference amplifier as the primary control element.

This circuit also employs error detection and amplified feedback compensation. It is an improved version over the basic series pass regulator shown in Figure 6-10. The series element is composed of a Darlington high gain configuration formed by Q1 and Q2 for an improved regulation factor. The combined gain of the reference amplifier and Q3 is incorporated to control the series unit. This reduced the required collector current change of the reference amplifier to control the regulator so that the bias current remains close to the specified current for low temperature coefficient. Also the germanium diode D1 will compensate for the base to emitter change in Q3 and keep the reference amplifier collector biasing current fairly constant with temperature changes. Proper biasing of the zener and transistor in the reference amplifier must be adhered to if the output voltage changes are to be minimized.

6

Constant Current Sources for Regulator Applications

Several places throughout this chapter emphasize the need for maintaining a constant current level in the various biasing circuits for optimum regulation. As was mentioned previously in the discussion on the basic series pass regulator, the current limiter diode can be effectively used for the purpose.

Aside from the current limiter diode a transistorized source can be used. A widely used technique is shown incorporated in a basic series pass regulator in Figure 6-14.

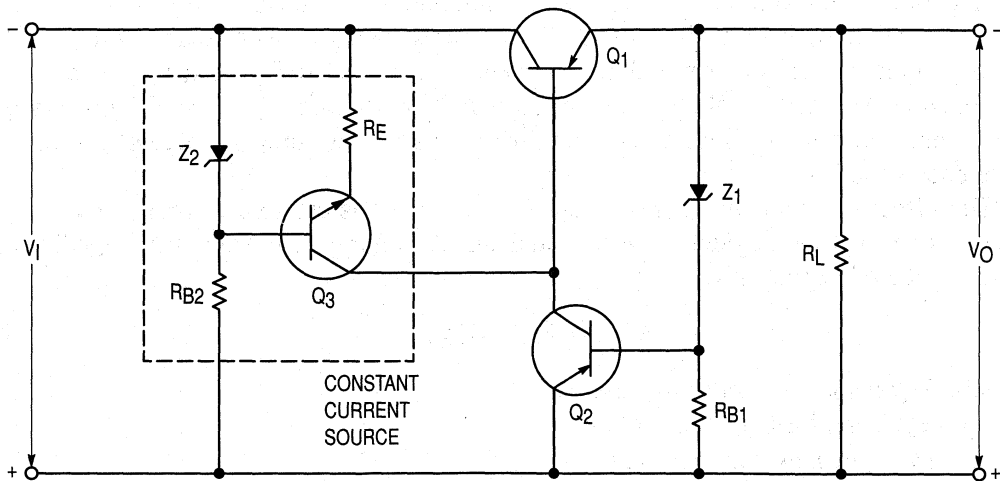

Figure 6-14. Constant Current Source Incorporated in a Basic Regulator Circuit

The circuit is used as a preregulated current source to supply the biasing current to the transistor Q_2 . The constant current circuit is seldom used alone, but does find wide use in conjunction with voltage regulators to supply biasing current to transistors or reference diodes for stable operation. The Zener Z_2 establishes a fixed voltage across R_E and the base to emitter of Q_3 . This gives an emitter current of $I_E = (V_Z - V_{BE})/R_E$ which will vary only slightly for changes in input voltage and temperature.

Impedance Cancellation

One of the most common applications of zener diodes is in the general category of reference voltage supplies. The function of the zener diode in such applications is to provide a stable reference voltage during input voltage variations. This function is complicated by the zener diode impedance, which effectively causes an incremental change in zener breakdown voltage with changing zener current.

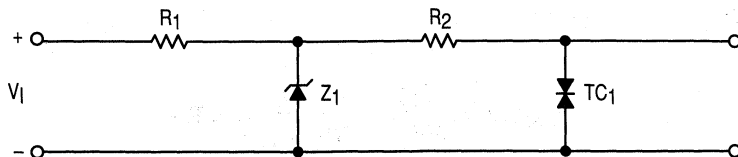

Figure 6-15. Impedance Cancellation with An Uncompensated Zener

It is possible, however, by employing a bridge type circuit which includes the zener diode and current regulating resistance in its branch legs, to effectively cancel the effect of the zener impedance. Consider the circuit of Figure 6-15 as an example. This is the common

configuration for a zener diode voltage regulating system. The zener impedance at 20 mA of a 1N4740 diode is typically 2 ohms. If the supply voltage now changes from 30 V to 40 V, the diode current determined by R_1 changes from 20 to 30 mA; the average zener impedance becomes 1.9 ohms; and the reference voltage shifts by 19 mV. This represents a reference change of .19%, an amount far too large for an input change of 30% in most reference supplies.

The effect of zener impedance change with current is relatively small for most input changes and will be neglected for this analysis. Assuming constant zener impedance, the zener voltage is approximated by

$$V'_Z = V_Z + Z(I'_Z - I_Z) \quad (6-37)$$

where V'_Z is the new zener voltage

V_Z is the former zener voltage

I'_Z is the new zener current

I_Z is the new zener current flowing at V_Z

R_Z is the zener impedance

Then $\Delta V_Z = Z\Delta I_Z$

Let the input voltage V_I in Figure 6-15 increase by an amount ΔV_I

$$\text{Then } \Delta I = \frac{\Delta V_I - \Delta V_Z}{R_1} \quad (6-38)$$

$$\text{Also } \Delta I = \frac{\Delta V_Z}{R_Z} \quad (6-39)$$

$$\text{Solving } \Delta V_I R_Z - \Delta V_Z R_Z - \Delta V_Z R_1 = 0$$

$$\text{Or } \frac{\Delta V_Z}{\Delta V_I} = \frac{R_Z}{R_1 + R_Z} \quad (6-40)$$

Equation 6-40 merely states that the change in reference voltage with input tends to zero when the zener impedance tends also to zero, as expected.

6

The figure of merit equation can be applied to the circuits of Figure 6-16 and 6-17 to explain impedance cancellation. The Change Factor equations for each leg and the reference voltage V_R are:

$$CF_{VZ} = \frac{\Delta V_Z}{\Delta V_I} = \frac{R_Z}{R_1 + R_Z} = R_A \quad (6-41)$$

$$CF_{V2} = \frac{\Delta V_2}{\Delta V_I} = \frac{R_3}{R_2 + R_3} = R_B \quad (6-42)$$

$$CF_{VR} = \frac{\Delta V_R}{\Delta V_I} = \frac{R_Z}{R_1 + R_Z} = \frac{R_3}{R_2 + R_3} = R_A - R_B \quad (6-43)$$

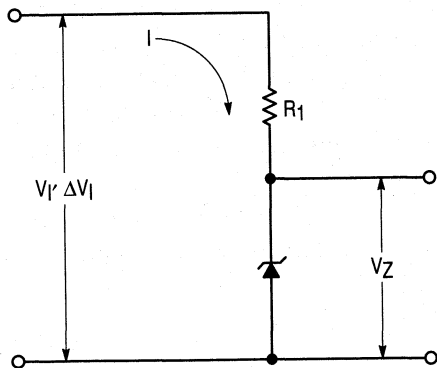

Figure 6-16. Standard Voltage Regulation Circuit

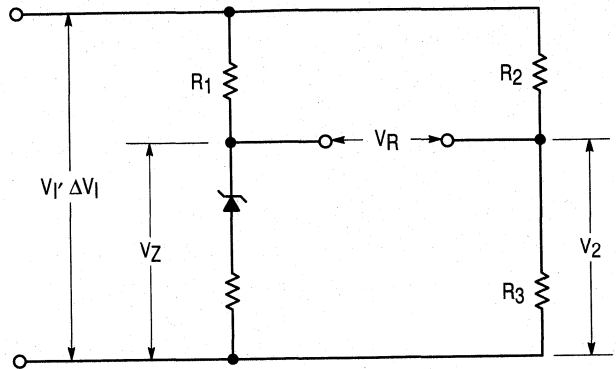

Figure 6-17. Impedance Cancellation Bridge

Since the design is to minimize CFVR, R_B can be set equal to R_A . The Input Regulation Factors are:

$$\gamma^{VZ} = \frac{\Delta VZ}{\Delta V_1} \left(\frac{V_1}{VZ} \right) = \frac{1}{1 + \frac{VZ}{V_1} \left(\frac{R_1}{RZ} \right)} \quad (6-44)$$

$$\gamma^{V2} = \frac{\Delta V_2}{\Delta V_1} \left(\frac{V_1}{V_2} \right) = 1 \quad (6-45)$$

$$\gamma^{VR} = \frac{\Delta VR}{\Delta V_1} \left(\frac{V_1}{VR} \right) = \frac{1}{1 + \left(\frac{VZ}{V_1} \right) \left(\frac{R_1}{RZ} \right) \left(\frac{1}{1 - \frac{R_B}{R_A}} \right)} \quad (6-46)$$

It is seen that γ^{VR} can be minimized by setting $R_B = R_A$.

Note that it is not necessary to match R_3 to R_Z and R_2 to R_1 . Thus R_3 and R_2 can be large and hence dissipate low power. This discussion is assuming very light load currents.

CHAPTER 7: ZENER PROTECTIVE CIRCUITS AND TECHNIQUES BASIC DESIGN CONSIDERATIONS

Introduction

The reliability of any system is a function of the ability of the equipment to operate satisfactorily during moderate changes of environment, and to protect itself during otherwise damaging catastrophic changes. The silicon zener diode offers a convenient, simple but effective means of achieving this result. Its precise voltage sensitive breakdown characteristic provides an accurate limiting element in the protective circuit. The extremely high switching speed possible with the zener phenomenon allows the circuit to react faster by orders of magnitude that comparable mechanical and magnetic systems.

By shunting a component, circuit, or system with a zener diode, the applied voltage cannot exceed that of the particular device's breakdown voltage. (See Figure 7-1.)

A device should be chosen so that its zener voltage is somewhat higher than the nominal operating voltage but lower than the value of voltage that would be damaging if allowed to pass. In order to adequately incorporate the zener diode for circuit protection, the designer must consider several factors in addition to the required zener voltage. The first thing the designer should know is just what transient characteristics can be anticipated, such as magnitude, duration, and the rate of reoccurrence. For short duration transients, it is usually possible to suppress the voltage spike and allow the zener to shunt the transient current away from the load without a circuit shutdown. On the other hand, if the over-voltage condition is for a long duration, the protective circuit may need to be complimented with a disconnect element to protect the zener from damage created by excessive heating. In all cases, the end circuit will have to be designed around the junction temperature limits of the device.

The following sections illustrate the most common zener protective circuits, and will demonstrate the criteria to be followed for an adequate design.

Basic Protective Circuits For Supply Transients

The simple zener shunt protection circuit shown in Figure 7-1 is widely used for supply voltage transient protection where the duration is relatively short. The circuit applies whether the load is an individual component or a complete circuit requiring protection. Whenever the input exceeds the zener voltage, the device avalanches into conduction clamping the load voltage to V_Z . The total current the diode must carry is determined by the magnitude of the input voltage transient and the total circuit impedance minus the load current. The worst case occurs when load current is zero and may be expressed as follows:

$$I_{Z(\max)} = \frac{V_{I(\max)} - V_Z}{R_S} \quad (7-1)$$

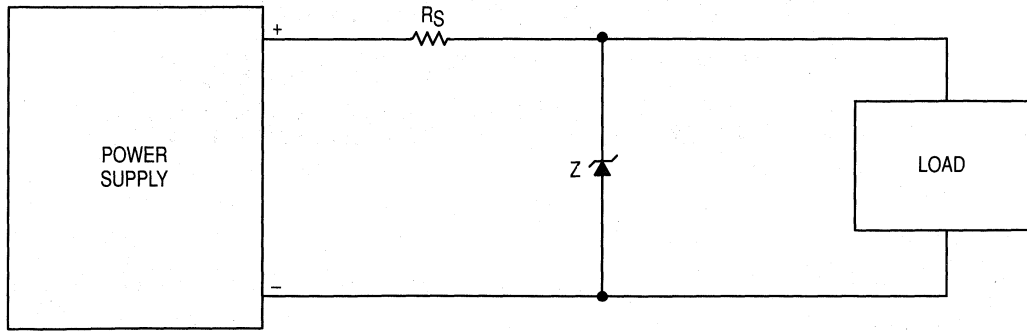

Figure 7-1. Basic Shunt Zener Transient Protection Circuit

The maximum power dissipated by the zener is

$$P_{Z(\max)} = I_{Z(\max)} V_{Z(\max)} = \frac{V_{I(\max)} - V_Z}{R_S} V_{Z(\max)} \quad (7-2)$$

Also, more than one device can be used, i.e., a series string, which will reduce the percentage of total power to be dissipated per device by a factor equal to the number of devices in series. The number of diodes required can be found from the following expression:

$$\text{Number} = \frac{P_{Z(\max)}}{P_Z (\text{allowable per device})} \quad (7-3)$$

Any fraction of a zener must be taken as the next highest whole number. This design discussion has been based upon the assumption that the transient is of a single shot, non-recurrent type. For all practical purposes it can be considered non-recurrent if the “off period” between transients is at least four times the thermal time constant of the device. If the “off period” is shorter than this, then the design calculations must include a factor for the duty cycle. This is discussed in detail in Chapter 4. In Chapter 4 there are also some typical curves relating peak power, pulse duration and duty cycle that may be appropriate for some designs.

Obviously, the factor that limits the feasibility of the basic zener shunt protective circuit is the pulse durations “t”. As the duration increases, the allowable peak power for a given configuration decreases and will approach a steady state condition.

When the anticipated transients expected to prevail for a specific situation are of long duration, a basic zener shunt becomes impractical, in such a case the circuit can be improved by using a complementary disconnect element. The most common overload protective element is without a doubt the standard fuse. The common fuse adequately protects circuit components from over-voltage surges, but at the same time must be chosen to eliminate “nuisance fusing” which results when the maximum current rating of the fuse is too close to the normal operational current of the circuit.

An Example Problem: Selecting A Fuse-Zener Combination

Consider the case illustrated in Figure 7-2. Here the load components are represented by a parallel combination of R and C , equivalent to many loads found in practice. The maximum capacitor voltage rating is usually the circuit-voltage limiting factor due to the cost of high voltage capacitors. Consequently, a protective circuit must be designed to prevent voltage surges greater than 1.5 times normal working voltage of the capacitor. It is common, however, for the supply voltage to increase to 135% normal for long periods. Examination of fuse manufacturers' melting time-current curves shows the difficulty of trying to select a fuse which will melt rapidly at overload (within one or two cycles of the supply frequency to prevent capacitor damage), and will not melt when subjected to voltages close to overload for prolonged periods.

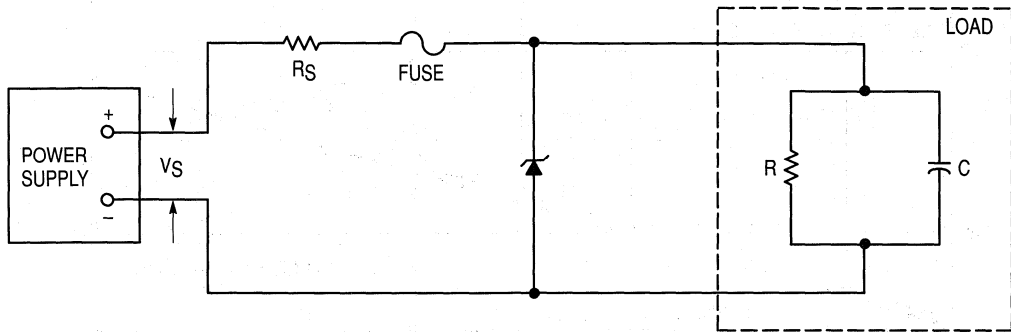

Figure 7-2. Overvoltage Protection with Zener Diodes and Fuses

By connecting a zener diode of correct voltage ratings across the load as shown, a fuse large enough to withstand normal current increases for long periods may be chosen. The sudden current increase when zener breakdown occurs melts the fuse rapidly and protects the load from large surges. In Figure 7-3, fuse current was plotted against supply voltage to illustrate the improvement in load protection obtained with zener-fuse combinations. Fuse current "A" would be selected to limit current resulting from voltage surges above 112 V to 90 mA, which would melt the fuse in 100 ms. It is a simple matter, however, to select a fuse which melts in 30 ms at 200 mA but is unaffected by 100 mA currents. The zener connection allows fuse current "B" to be selected, eliminating this design problem and providing a faster, more reliable protective circuit. If the same fuse was used without the zener diode, a supply voltage of 210 volts would be reached before the fuse would begin to protect the load.

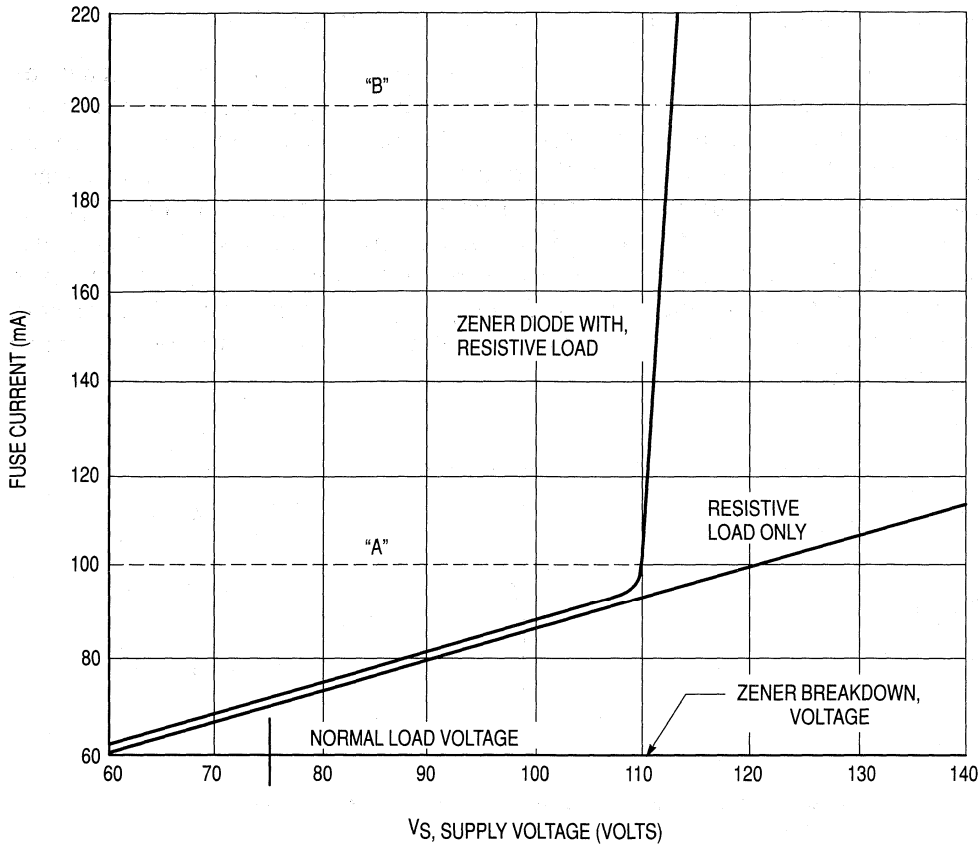

Figure 7-3. Fuse Current versus Supply Voltage

6

Selection of the correct power rating of zener diodes to be used for surge protection depends upon the magnitude and duration of anticipated surges. Often in circuits employing both fuses and zener diodes, the limiting surge duration will be the melting time of the fuse. This, in turn, depends on the nature of the load protected and the length of time it will tolerate an overload.

As a first solution to the example problem, consider a zener diode with a nominal breakdown voltage of 110 volts measured at a test current (I_{ZT}) of 110 mA. Since the fuse requires about 200 mA to melt and 100 mA are drawn through the load at this voltage, the load voltage will never exceed the zener breakdown voltage on slowly rising inputs. Transients producing currents of approximately 200 mA but of shorter duration than 30 ms will simply be clipped by zener action and diverted from the load. Transients of very high voltage will produce larger currents and, hence, will melt the fuse more rapidly. In the limiting case where transient power might eventually destroy the zener diode, the fuse always melts first because of the slower thermal time constant inherent in the zener diode's larger geometry.

The curves in Figure 7-4 illustrate the change in zener voltage as a function of changing current for a typical device type.

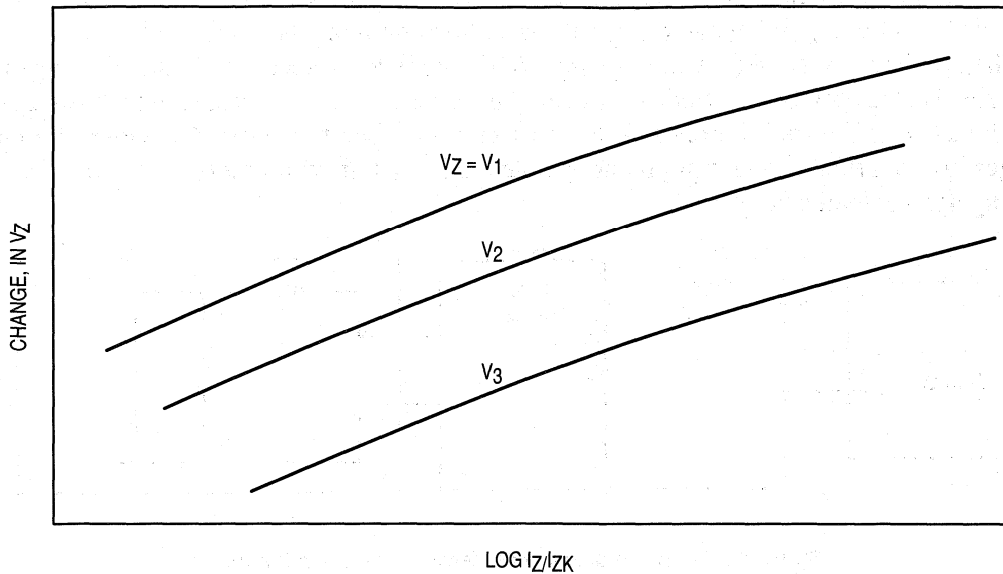

Figure 7-4. Change in V_Z for Changes in I_Z

If an actual curve for the device being used is not available, the zener voltage at a specific current above or below the test current may be approximated by equation 7-4.

$$\text{Where: } V = V_Z + Z_{ZT} (I - I_{ZT}) \quad (7-4)$$

V_Z = zener voltage at test current I_{ZT}

Z_{ZT} = zener impedance at test current I_{ZT}

I_{ZT} = test current

V = zener voltage at current I

For a given design, the maximum zener voltage to expect for the higher zener current should be determined to make sure the limits of the circuit are met. If the maximum limit is excessive for the original device selection, the next lower voltage rating should be used.

The previous discussion on design consideration for protective circuits incorporating fuses is applicable to any protective element that permanently disconnects the supply when actuated. Rather than a fuse, a non-resetting magnetic circuit breaker could have been used, and the same reasoning would have applied.

Load Current Surges

In many actual problems the designer must choose a protective circuit to perform still another task. Not only must the equipment be protected from the voltage surges in the supply, but the supply itself often requires protection from shorts or partial shorts in the load. A direct short in the load is fairly easy to handle, as the drastic current change permits the use of fuses with ratings high enough to avoid problems with supply surges. More common is the partial short, as illustrated in Figure 7-5. If a short circuit occurs in the capacitive section of the load (represented by C) the resulting fault current is limited by the resistive section (represented

by R) to a value which may not be great enough to melt the fuse. The fault current could be sufficient, however, to damage the supply and other components in the load.

The problem is resolved by employing a zener diode to protect against supply surges as described in the previous section, and by selecting a separate fuse to protect from load faults. The load fuse in Figure 7-5 is chosen close to the normal operating current. Abnormal supply surges do not affect it and equipment operates reliably but with ample protection for the supply against load changes.

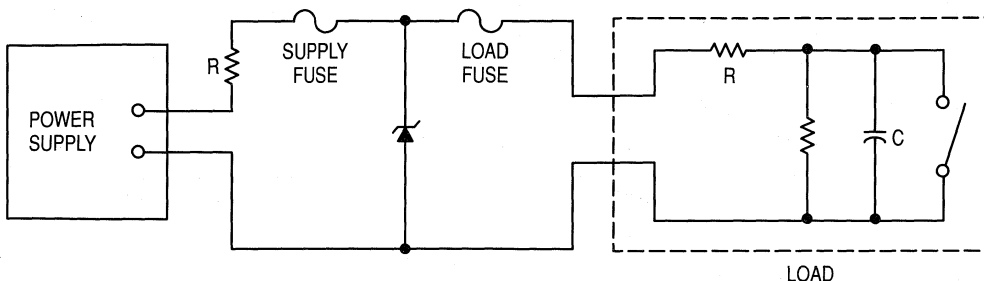

Figure 7-5. Supply and Load with Zener Diode; Fuse Circuitry

Zener Diodes and Reclosing Disconnect Elements

An interesting application of zener diodes as overvoltage protectors, which offers the possibility of designing for both long and short duration surges, is shown in Figure 7-6.

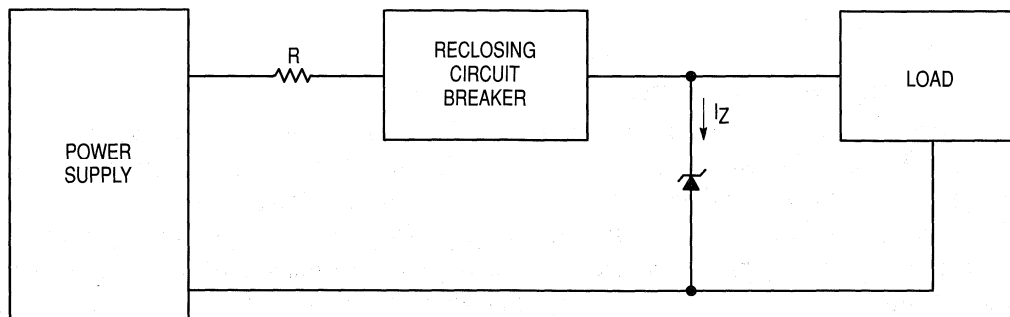

Figure 7-6. Zener Diode Reclosing Circuit Breaker Protective Circuit

In the event of a voltage overload exceeding a chosen zener voltage, a large current will be drawn through the diode. The reclosing disconnect element opens after an interval determined by its time constant, and the supply is disconnected. After another interval, again depending on the switch characteristics, the supply is reconnected and the voltage “sampled” by the zener diode. This leads to an “on-off” action which continues until the supply voltage drops below the predetermined limit. At no time can the load voltage or current exceed that set by the zener. The chief advantage in this type of circuit is the elimination of fuse replacement in similar fusing circuits, while providing essentially the same load protection.

It is difficult to define a set design procedure in this case, because of the wide variety of reclosing, magnetic and thermal circuit breakers available. Care should be taken to ensure that the power dissipated in the zener diode during the conduction time of the disconnect element does not exceed its rating. As an example, assume the disconnect element was a thermal breaker switch. The waveforms for a typical over-voltage situation are shown in Figure 7-7.

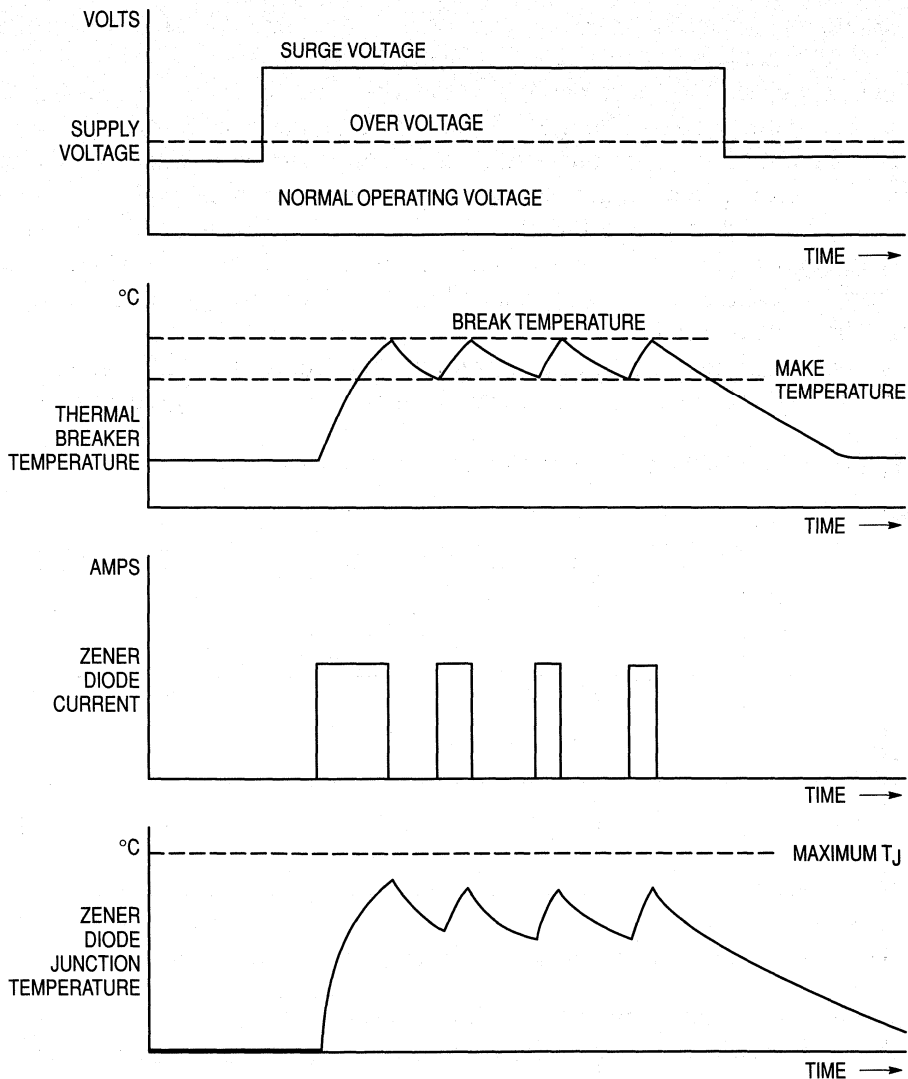

Figure 7-7. (Typical) Voltage, Current and Temperature Waveforms for a Thermal Breaker

It is apparent that the highest zener diode junction temperature is reached during the first conduction period. At this time the thermal breaker is cold and requires the greatest time to reach its break temperature. The breaker then cycles thermally between the make and break

temperatures as long as the supply voltage is greater than the zener voltage, as shown in Figure 7-7.

The zener diode current and junction temperature variation are shown in the last two waveforms of Figure 7-7. Overvoltage durations longer than the trip time of the thermal breaker do not affect the diode as the supply is disconnected. An overvoltage of much higher level simply causes the thermal breaker to open sooner. In effect, the zener diode rating must be high enough to ensure that maximum junction temperature is not reached during the longest interval that the thermal switch will be closed.

Manufacturers of thermally operated circuit breakers publish current-time curves for their devices similar to that shown in Figure 7-8. By estimating the peak supply overvoltage and determining the maximum overvoltage tolerated by the load, an estimation of peak zener current can be made. The maximum breaker trip time may then be read from Figure 7-8. (After the initial current surge, the duration of "of" time is determined entirely by the breaker characteristics and will vary widely with manufacture.) The zener diode junction temperature rise during conduction may be calculated now from the thermal time constant of the device and the heatsink used.

Because the reclosing circuit breaker is continually cycling on and off, the zener current takes on the characteristics of a repetitive surge, as can be seen in Figure 7-7.

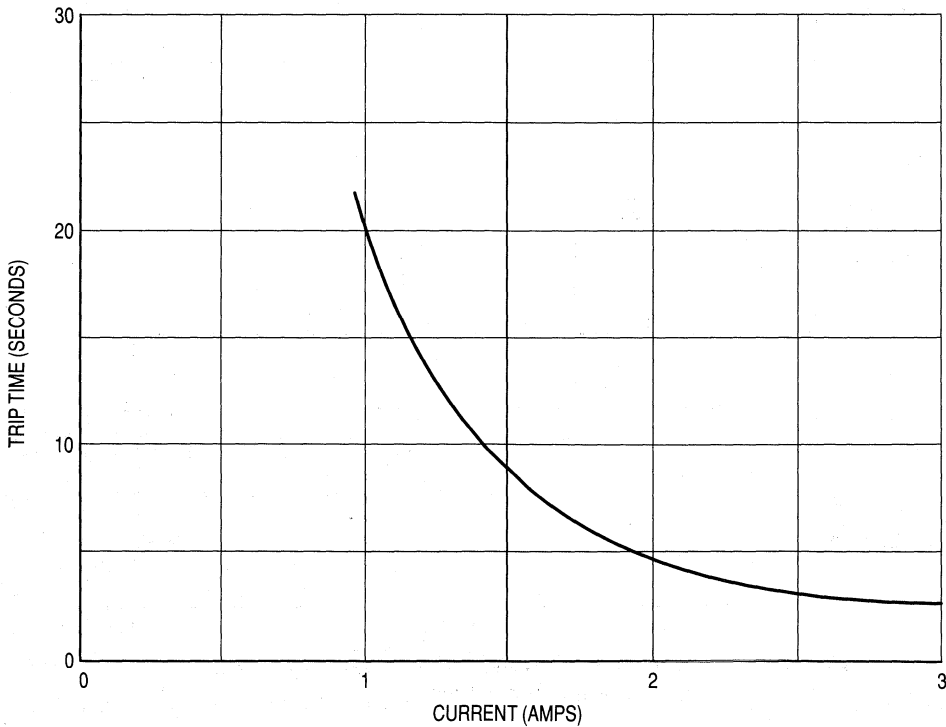

Figure 7-8. Trip Time versus Current for Thermal Breaker

Transistor Overvoltage Protection

In many electronic circuits employing transistors, high internal voltages can be developed and, if applied to the transistors, will destroy them. This situation is quite common in transistor circuits that are switching highly inductive loads. A prime example of this would be in transistorized electronic ignition systems such as shown in Figures 7-9a and 7-9b.

The zener diode is an important component to assure solid state ignition system reliability. There are two basic methods of using a zener diode to protect an ignition transistor. These are shown in Figures 7-9a and 7-9b. In Figure 7-9b the transistor is protected by a zener diode connected between base and collector and in Figure 7-9a, the zener is connected between emitter and collector. In both cases the voltage level of the zener must be selected carefully so that the voltage stress on the transistor is in a region where the safe operating area is adequate for reliable circuit operation.

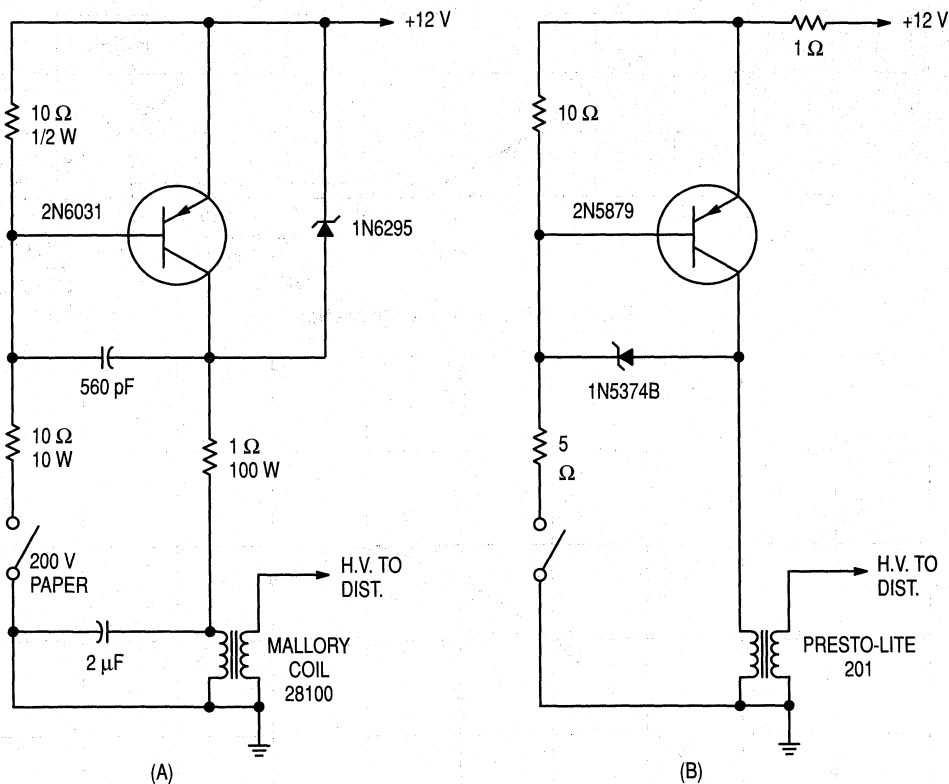

Figure 7-9. Transistor Ignition Systems with Zener Overvoltage Surge Protection

Figure 7-10 illustrates "safe" and "unsafe" selection of a zener diode for collector-base protection of a transistor in the ignition coil circuit. It can be seen that the safe operating area of a transistor must be known if an adequate protective zener is to be selected.

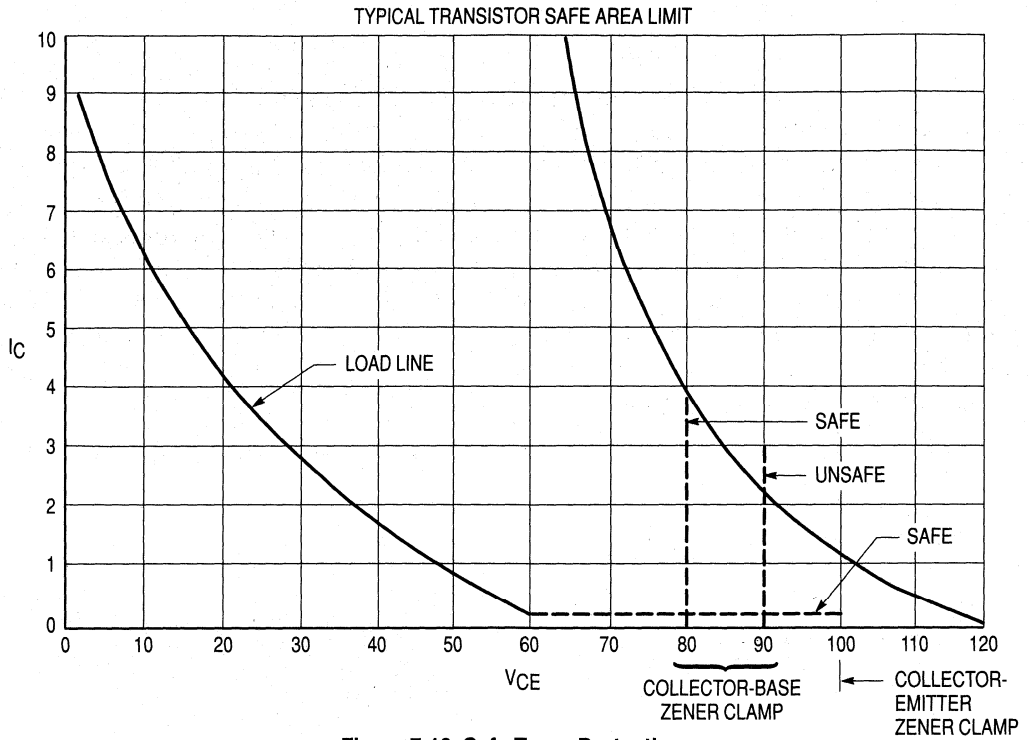

Figure 7-10. Safe Zener Protection

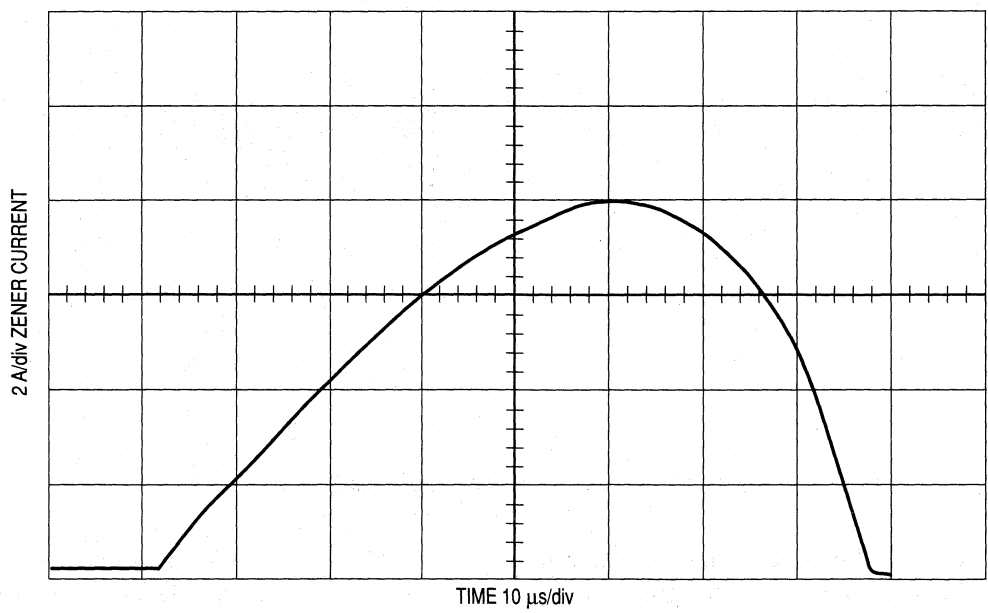

Figure 7-11. Zener Diode Current Pulse

6

The zener diode must be able to take the stress of peak pulse current necessary to clamp the voltage rise across the transistor to a safe value. In a typical case, a 5 watt, 100 volt zener transient suppressor diode is required to operate with an 80 μ s peak pulse current of 8 amperes when connected between the collector-emitter of the transistor. The waveform of this pulse current approaches a sine wave in shape (Figure 7-11). The voltage rise across a typical transient suppressor diode due to this current pulse is shown in Figure 7-12. This voltage rise of approximately 8 volts indicates an effective zener impedance of approximately 1 ohm. However, a good share of this voltage rise is due to the temperature coefficient and thermal time constant of the zener. The temperature rise of the zener diode junction is indicated by the voltage difference between the rise and fall of the current pulse.

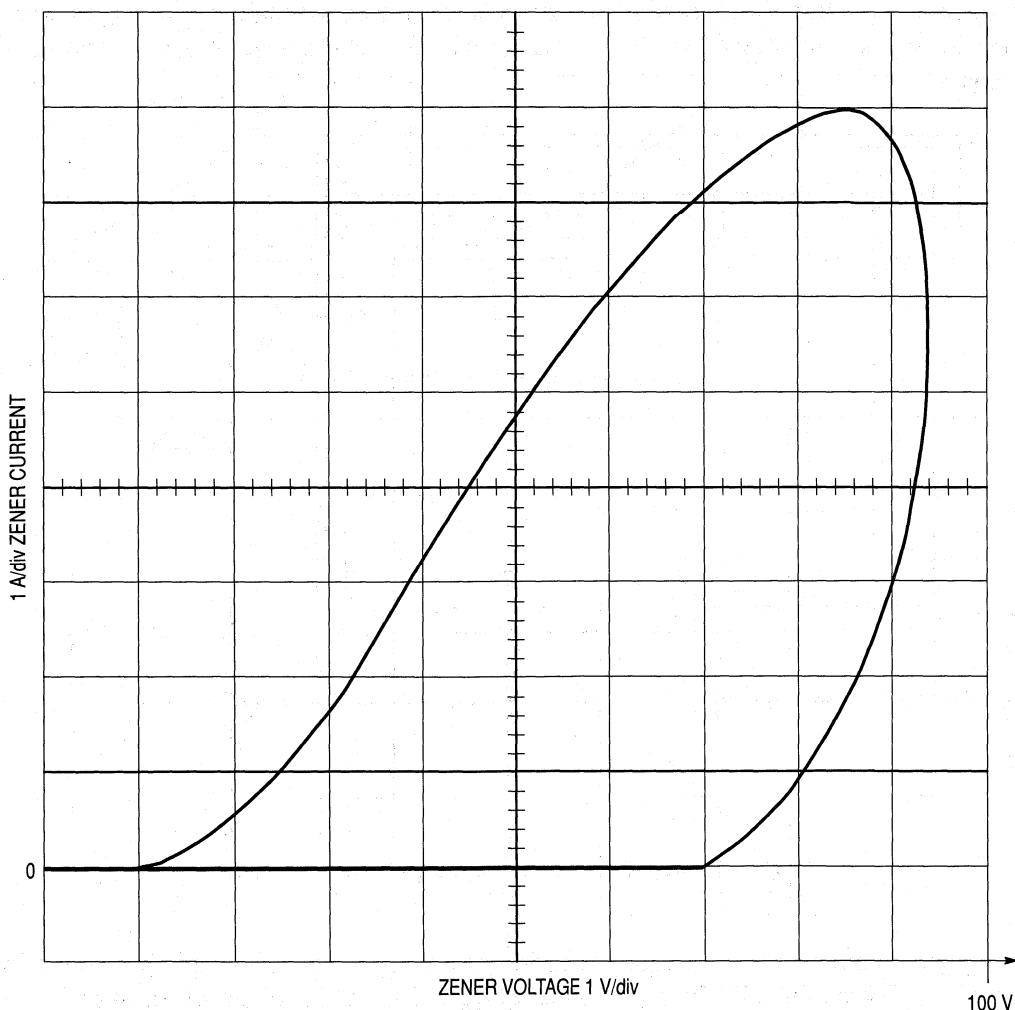

Figure 7-12. Voltage-Current Representation on 100 V Zener

In order to assure safe operation, the change in zener junction temperature for the peak pulse conditions must be analyzed. In making the calculation, the method described in Chapter 4 should be used, taking into account duty cycle, pulse duration, and pulse magnitude.

When the zener diode is connected between the collector and emitter of the transistor, additional power dissipation will result from the clipping of the ringing voltage of the ignition coil by the forward conduction of the zener diode. This power dissipation by the forward diode current will result in additional zener voltage rise. It is not uncommon to observe a 15-volt rise above the zener device voltage rating due to temperature coefficient and impedance under these pulse current conditions.

The zener diode should be connected as close as possible to the terminals of the transistor the zener is intended to protect. This insures that induced voltage transients, caused by current changes in long lead lengths, are clamped by the zener and do not appear across the transistor.

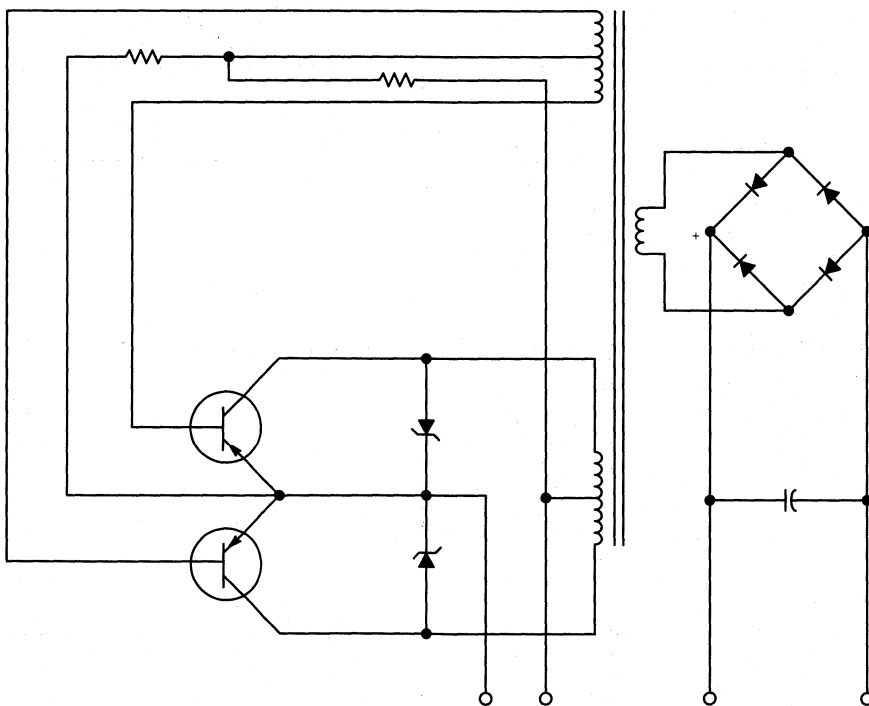

Figure 7-13. DC-DC Converter with Surge Protecting Diodes

Another example of overvoltage protection of transistor operating in an inductive load switch capacity is illustrated in Figure 7-13. The DC-DC converter circuit shows a connection from collector to emitter of two zener diodes as collector overvoltage protectors. Without some type of limiting device, large voltage spikes may appear at the collectors, due to

the switching transients produced with normal circuit operation. When this spike exceeds the collector breakdown rating of the transistor, transistor life is considerably shortened. The zener diodes shown are chosen with zener breakdowns slightly below transistor breakdown voltage to provide the necessary clipping action. Since the spikes are normally of short duration (0.5 to 5 μ s) and duty cycle is low, normal chassis mounting provides adequate heatsinking.

Meter Protection

The silicon zener diode can be employed to prevent overloading sensitive meter movements used in low range DC and AC voltmeters, without adversely affecting the meter linearity. The zener diode has the advantage over thermal protective devices of instantaneous action and, of course, will function repeatedly for an indefinite time (as compared to the reset time necessary with thermal devices). While zener protection is presently available for voltages as low as 2.4 volts, forward diode operation can be used for meter protection where the voltage drop is much smaller. A typical protective circuit is illustrated in Figure 7-14. Here the meter movement requires 100 μ Amps for full scale deflection and has 940 ohms resistance. For use in a voltmeter to measure 25 V, approximately 249 thousand ohms are required in series.

The protection provided by the addition of an 18 volt zener is illustrated in Figure 7-15. With an applied voltage of 25 volts, the 100 μ Amps current in the circuit produces a drop of 17.9 volts across the series resistance of 179 thousand ohms. A further increase in voltage

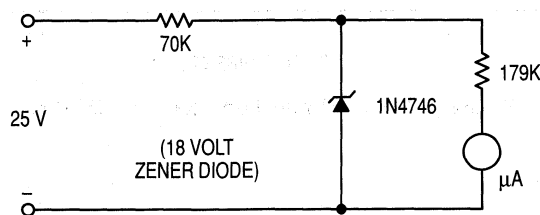

Figure 7-14. Meter Protection with Zener Diode

causes the zener diode to conduct, and the overload current is shunted away from the meter. Since Motorola zener diodes have zener voltages specified within 5 and 10%, a safe design may always be made with little sacrifice in meter linearity by assuming the lowest breakdown voltage within the tolerance. The shunting effect on the meter of the reverse biased diode is generally negligible below breakdown voltage (on the order of 0.5° full scale). For very precise work, the zener diode breakdown voltage must be accurately known and the design equations solved for the correct resistance values.

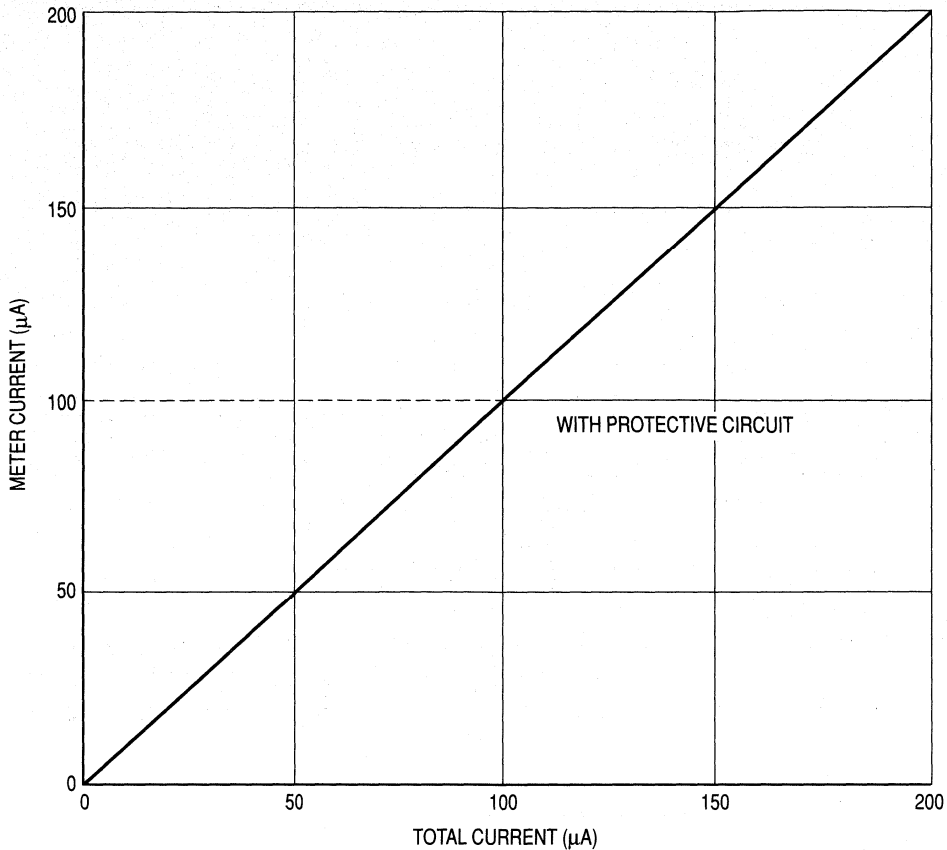

Figure 7-15. Meter Protection with Zener Diodes

6 Zener Diodes Used With SCRs For Circuit Protection

An interesting aspect of circuit protection incorporating the reliable zener diode is the protective circuits shown in Figures 7-16 and 7-17.

In a system that is handling large amounts of power, it may become impractical to employ standard zener shunt protection because of the large current it would be required to carry. The SCR crowbar technique shown in Figure 7-16 can be effectively used in these situations. The zener diode is still the transient detection component, but it is only required to carry the gate current for SCR turn on, and the SCR will carry the bulk of the shunt current. Whenever the incoming voltage exceeds the zener voltage, it avalanches, supplying gate drive to the SCR which, when fired, causes a current demand that will trip the circuit breaker. The resistors shown are for current limiting so that the SCR and zener ratings are not exceeded.

The circuit of Figure 7-17 is designed to disconnect the supply in the event a specified load current is exceeded. This is done by means of a series sense resistor and a compatible zener

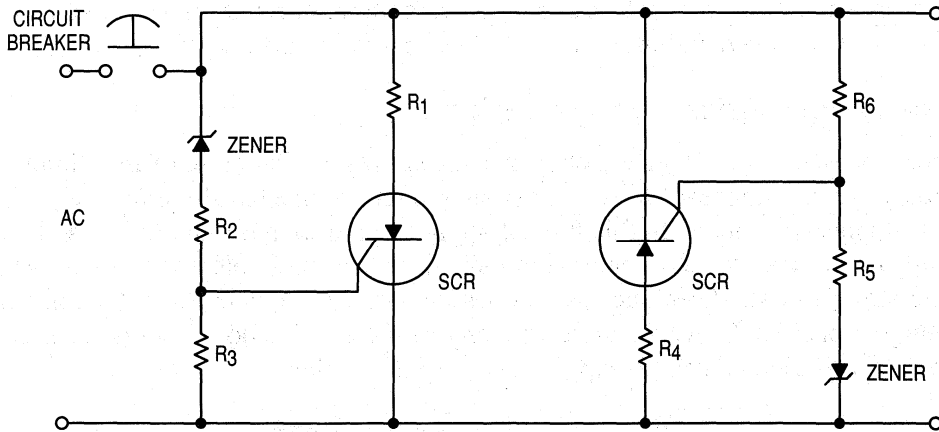

Figure 7-16. SCR Crowbar Over-Voltage Protection Circuit for AC Circuit Operation

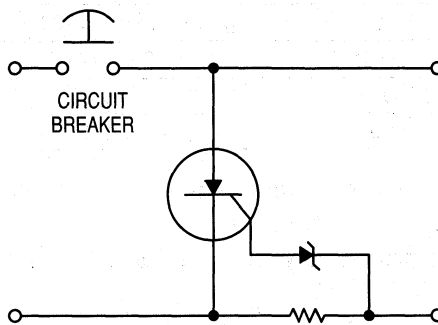

Figure 7-17. SCR Longterm Current Overload Protection

to turn the shunt SCR on. When the voltage across the series resistor, which is a function of the load current, becomes sufficient to break over the zener, the SCR is fired, causing the circuit breaker to trip.

Zener Transient Suppressors

The transient suppressor is used as a shunt element in exactly the same manner as a conventional zener. It offers the same advantages such as low insertion loss, immediate recovery after operation, a clamping factor approaching unity, protection against fast rising transients, and simple circuitry. The primary difference is that the transient suppressor extends these advantages to higher power levels.

Even in the event of transients with power contents far in excess of the capacity of the zeners, protection is still provided the load. When overloaded to failure, the zener will approximate a short. The resulting heavy drain will aid in opening the fuse or circuit breaker protecting the load against excess current. Thus, even if the suppressor is destroyed, it still protects the load.

The design of the suppressor-fuse combination for the required level of protection follows the techniques for conventional zeners discussed earlier in this chapter.

Transient Suppression Characteristics

Zener diodes, being nearly ideal clippers (that is, they exhibit close to an infinite impedance below the clipping level and close to a short circuit above the clipping level), are often used to suppress transients. In this type of application, it is important to know the power capability of the zener for short pulse durations, since they are intolerant of excessive stress.

Some Motorola data sheets such as the ones for devices shown in Table 7-1 contain short pulse surge capability. However, there are many data sheets that do not contain this data and Figure 7-18 is presented here to supplement this information.

Table 7-1. Transient Suppressor Diodes

Series Numbers	Steady State Power	Package	Description
1N4728A	1 W	DO-41	Double Slug Glass
1N6267A	5 W	Case 41A-02	Axial Lead Plastic
1N5333B	5 W	Case 17-02	Surmetic 40
1N746A/957B/4370A	500 mW	DO-35	Double Slug Glass
1N5221B	500 mW	DO-35	Double Slug Glass

Some data sheets have surge information which differs slightly from the data shown in Figure 7-18. A variety of reasons exist for this:

1. The surge data may be presented in terms of actual surge power instead of nominal power.
2. Product improvements have occurred since the data sheet was published.
3. Large dice are used, or special tests are imposed on the product to guarantee higher ratings than those shown in Figure 7-18.
4. The specifications may be based on a JEDEC registration or part number of another manufacturer.

The data of Figure 7-18 applies for non-repetitive conditions and at a lead temperature of 25°C. If the duty cycle increases, the peak power must be reduced as indicated by the curves of Figure 7-19. Average power must be derated as the lead or ambient temperature rises above 25°C. The average power derating curve normally given on data sheets may be normalized and used for this purpose.

When it is necessary to use a zener close to surge ratings, and a standard part having guaranteed surge limits is not suitable, a special part number may be created having a surge limit as part of the specification. Contact your nearest Motorola OEM sales office for capability, price, delivery, and minimum order quantities.

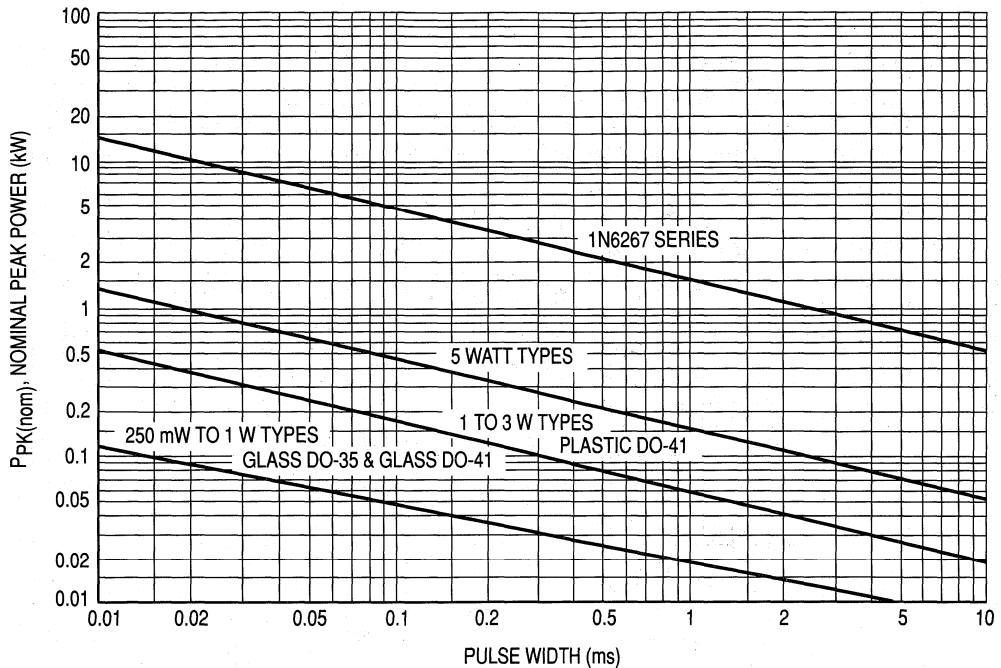

Figure 7-18. Peak Power Ratings of Zener Diodes

Mathematical Model

Since the power shown on the curves is not the actual transient power measured, but is the product of the peak current measured and the nominal zener voltage measured at the current used for voltage classification, the peak current can be calculated from:

$$I_{Z(PK)} = \frac{P(PK)}{V_{Z(nom)}} \quad (7-5)$$

The peak voltage at peak current can be calculated from:

$$V_{Z(PK)} = FC \times V_{Z(nom)} \quad (7-6)$$

where FC is the clamping factor. The clamping factor is approximately 1.20 for all zener diodes when operated at their pulse power limits. For example, a 5 watt, 20 volt zener can be expected to show a peak voltage of 24 volts regardless of whether it is handling 450 watts for 0.1 ms or 50 watts for 10 ms. This occurs because the voltage is a function of junction temperature and IR drop. Heating of the junction is more severe at the longer pulse width, causing a higher voltage component due to temperature which is roughly offset by the smaller IR voltage component.

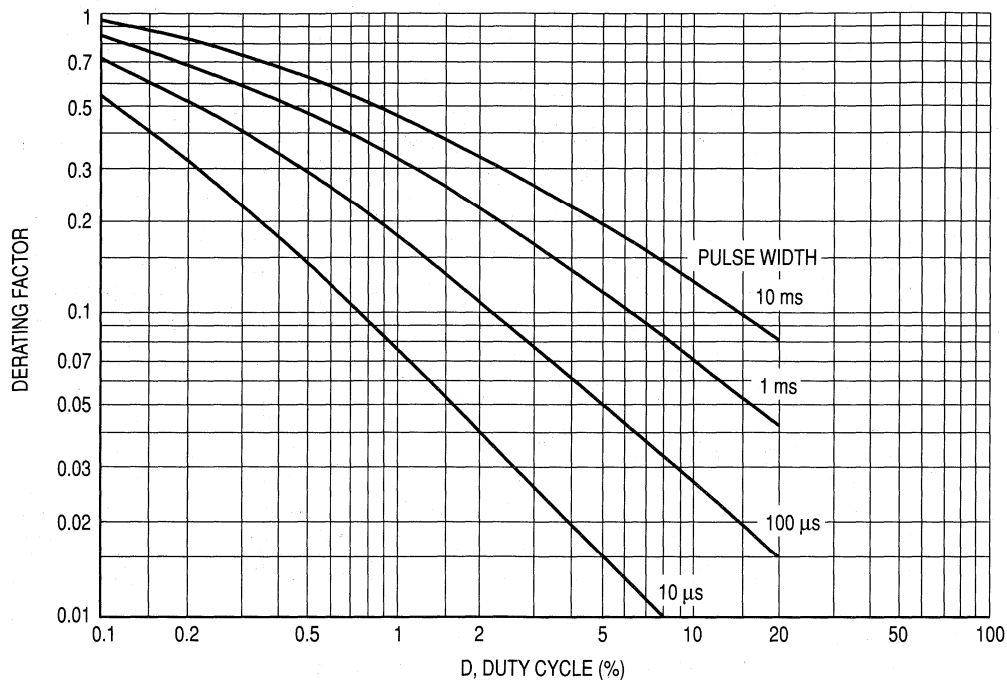

Figure 7-19. Typical Derating Factor for Duty Cycle

For modeling purposes, an approximation of the zener resistance is needed. It is obtained from:

$$R_{Z(\text{nom})} = \frac{V_{Z(\text{nom})}(FC-1)}{PPK(\text{nom}) / V_{Z(\text{nom})}} \quad (7-7)$$

6

The value is approximate because both the clamping factor and the actual resistance are a function of temperature.

Circuit Considerations

It is important that as much impedance as circuit constraints allow be placed in series with the zener diode and the components to be protected. The result will be a lower clipping voltage and less zener stress. A capacitor in parallel with the zener is also effective in reducing the stress imposed by very short duration transients.

To illustrate use of the data, a common application will be analyzed. The transistor in Figure 7-20 drives a 50 mH solenoid which requires 5 amperes of current. Without some means of clamping the voltage from the inductor when the transistor turns off, it could be destroyed.

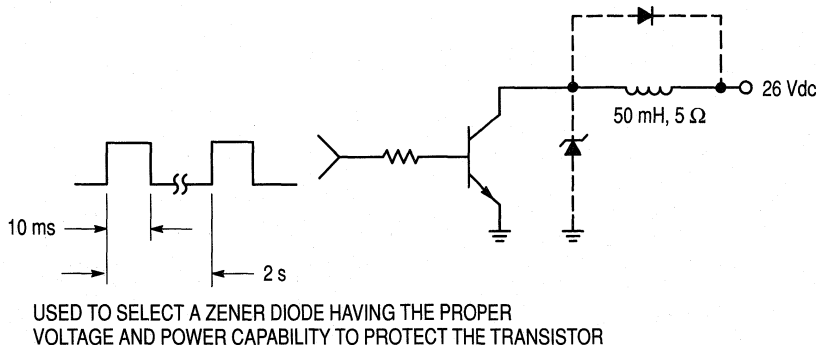

Figure 7-20. Circuit Example

The means most often used to solve the problem is to connect an ordinary rectifier diode across the coil; however, this technique may keep the current circulating through the coil for too long a time. Faster switching is achieved by allowing the voltage to rise to a level above the supply before being clamped. The voltage rating of the transistor is 60 V, indicating that approximately a 50 volt zener will be required.

The peak current will equal the on-state transistor current (5 amperes) and will decay exponentially as determined by the coil L/R time constant (neglecting the zener impedance). A rectangular pulse of width L/R (0.01 s) and amplitude of I_{PK} (5 A) contains the same energy and may be used to select a zener diode. The nominal zener power rating therefore must exceed $(5 \text{ A} \times 50) = 250$ watts at 10 ms and a duty cycle of $0.01/2 = 0.5\%$. From Figure 7-19, the duty cycle factor is 0.62 making the single pulse power rating required equal to $250/0.62 = 403$ watts. From Figure 7-18, one of the 1N6267 series zeners has the required capability. The 1N6287 is specified nominally at 47 volts and should prove satisfactory.

Although this series has specified maximum voltage limits, equation 7-7 will be used to determine the maximum zener voltage in order to demonstrate its use.

$$R_Z = \frac{47(1.20 - 1)}{500/47} = \frac{9.4}{10.64} = 0.9 \Omega$$

At 5 amperes, the peak voltage will be 4.5 volts above nominal or 51.5 volts total which is safely below the 60 volt transistor rating.

CHAPTER 8: ZENER VOLTAGE SENSING CIRCUITS AND APPLICATIONS

Basic Concepts of Voltage Sensing

Numerous electronic circuits require a signal or voltage level to be sensed for circuit actuation, function control, or circuit protection. The circuit may alter its mode of operation whenever an interdependent signal reaches a particular magnitude (either higher or lower than a specified value). These sensing functions may be accomplished by incorporating a voltage dependent device in the system creating a switching action that controls the overall operation of the circuit.

The zener diode is ideally suited for most sensing applications because of its voltage dependent characteristics. The following sections are some of the more common applications and techniques that utilize the zener in a voltage sensing capacity.

Transistor-Zener Sensing Circuits

The zener diode probably finds its greatest use in sensing applications in conjunction with other semiconductor devices. Two basic widely used techniques are illustrated in Figures 8-1a and 8-1b.

In both of these circuits the output is a function of the input voltage level. As the input goes from low to high, the output will switch from either high to low (base sense circuit) or low to high (emitter sense circuit), (see Figure 8-2).

The base sense circuit of Figure 8-1a operates as follows: When the input voltage is low, the voltage dropped across R_2 is not sufficient to bias the zener diode and base emitter junction into conduction, therefore, the transistor will not conduct. This causes a high voltage from collector to emitter. When the input becomes high, the zener is biased into conduction, the transistor turns on, and the collector to emitter voltage, which is the output, drops to a low value.

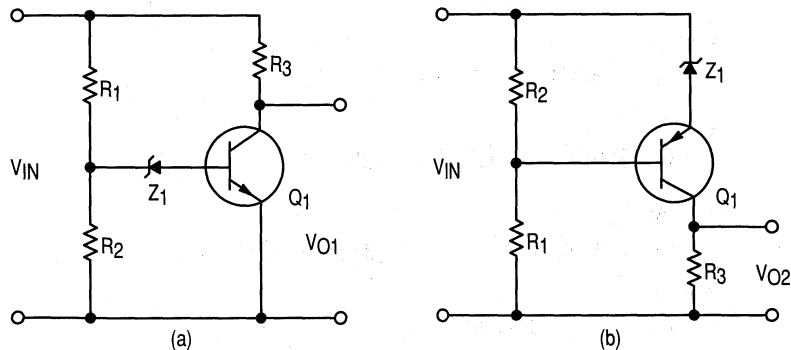

Figure 8-1. Basic Transistor-Zener Diode Sensing Circuits

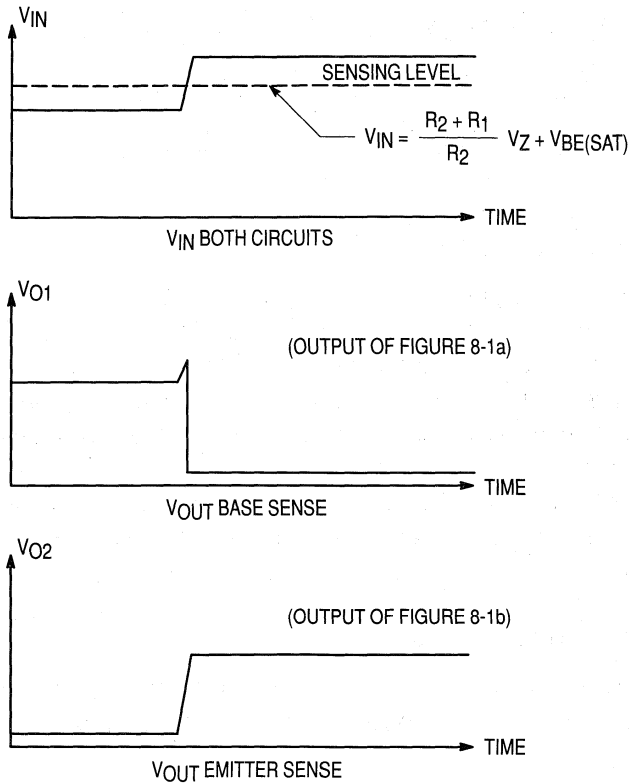

Figure 8-2. Outputs of Transistor-Zener Voltage Sensing Circuits

The emitter sense circuit of Figure 8-1b operates as follows: When the input is low the voltage drop across R_3 (the output) is negligible. As the input voltage increases the voltage drop across R_2 biases the zener into conduction and forward biases the base-emitter junction. A large voltage drop across R_3 (the output voltage) is equal to the product of the collector current times the resistance, R_3 . The following relationships indicate the basic operating conditions for the circuits in Figure 8-1.

Circuit	Output
8-1a	$\left\{ \begin{array}{l} \text{High} \\ V_{OUT} = V_{IN} - I_C R_3 \cong V_{IN} \\ \text{Low} \\ V_{OUT} = V_{IN} - I_C R_3 = V_{CE(sat)} \end{array} \right.$
8-1b	$\left\{ \begin{array}{l} \text{Low} \\ V_{OUT} = V_{IN} - V_Z - V_{CE(off)} = I_C R_3 \\ \text{High} \\ V_{OUT} = V_{IN} - V_{CE(sat)} = I_C R_3 \end{array} \right.$

In addition, the basic circuits of Figure 8-1 can be rearranged to provide inverse output.

Automotive Alternator Voltage Regulator

Electromechanical devices have been employed for many years as voltage regulators, however, the regulation setting of these devices tend to change and have mechanical contact problems. A solid state regulator that controls the charge rate by sensing the battery voltage is inherently more accurate and reliable. A schematic of a simplified solid state voltage regulator is shown in Figure 8-3.

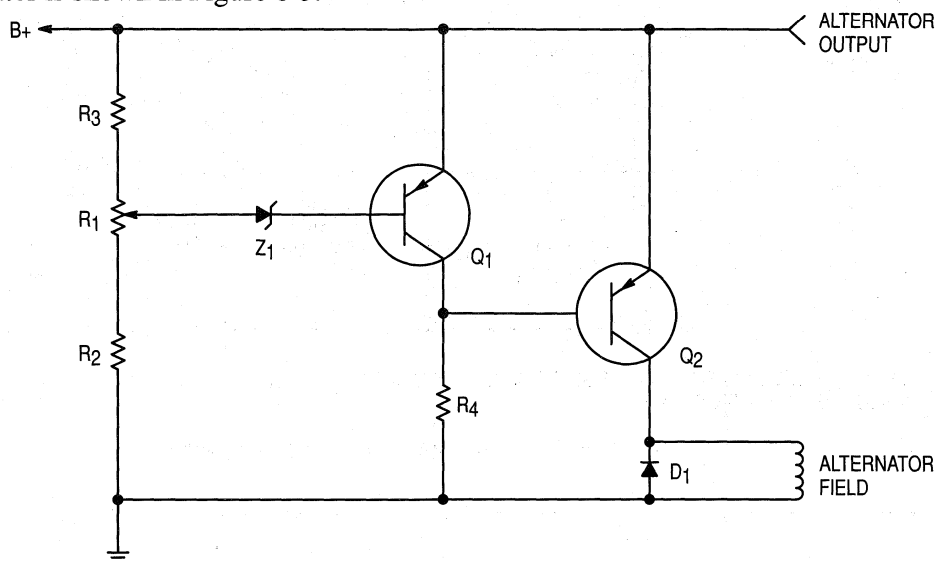
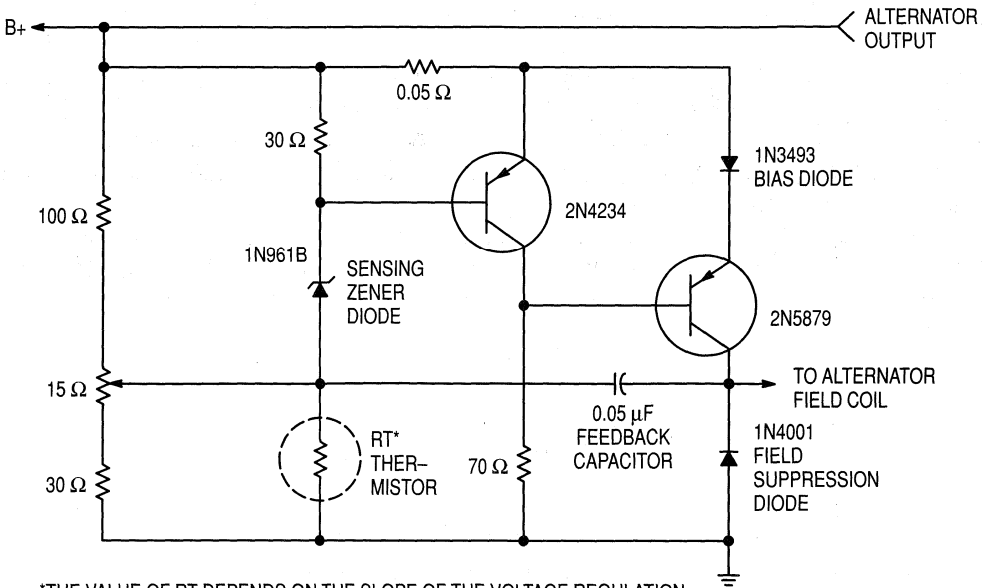

Figure 8-3. Simplified Solid State Voltage Regulator

The purpose of an alternator regulator is to control the battery charging current from the alternator. The charge level of the battery is proportional to the battery voltage level. Consequently, the regulator must monitor the battery voltage level allowing charging current to pass when the battery voltage is low. When the battery has attained the proper charge the charging current is switched off. In the case of the solid state regulator of Figure 8-3, the charging current is controlled by switching the alternator field current on and off with a series transistor switch, Q2. The switching action of Q2 is controlled by a voltage sensing circuit that is identical to the base sense circuit of Figure 8-1a. When under-charged, the zener Z1 does not conduct keeping Q1 off. The collector-emitter voltage of Q1 supplies a forward bias to the base-emitter of Q2, turning it on. With Q2 turned on, the alternator field is energized allowing a charging current to be delivered to the battery. When the battery attains a proper charge level, the zener conducts causing Q1 to turn on, and effectively shorting out the base-emitter junction of Q2. This short circuit cuts off Q2, turns off the current flowing in the field coil which consequently, reduces the output of the alternator. Diode D1 acts as a field suppressor preventing the build up of a high induced voltage across the coil when the coil current is interrupted.

In actual operation, this switching action occurs many times each second, depending upon the current drain from the battery. The battery charge, therefore, remains essentially constant and at the maximum value for optimum operation.



*THE VALUE OF R_T DEPENDS ON THE SLOPE OF THE VOLTAGE REGULATION VERSUS TEMPERATURE CURVE.

Figure 8-4. Complete Solid State Alternator Voltage Regulator

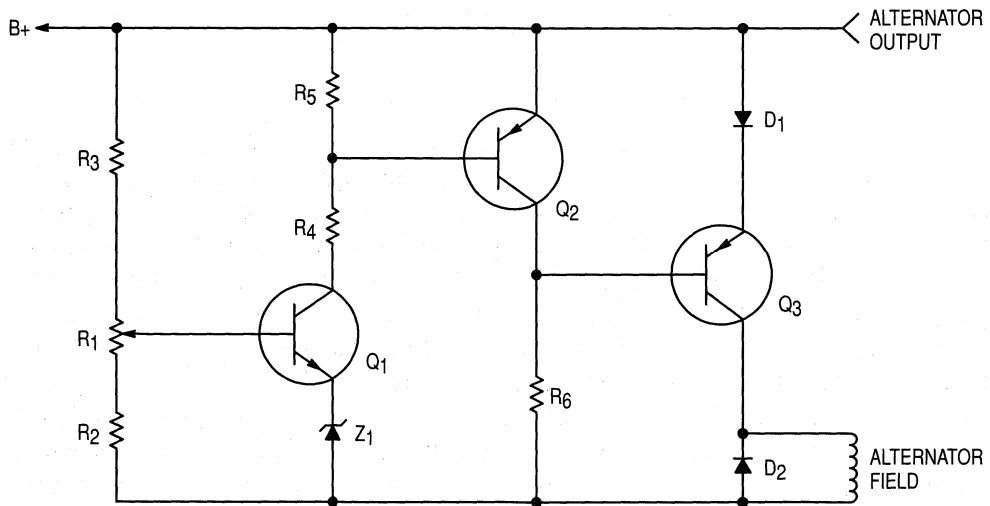

Figure 8-5. Alternator Regulator With Emitter Sensor

A schematic of a complete alternator voltage regulator is shown in Figure 8-4.

It is also possible to perform the alternator regulation function with the sensing element in the emitter of the control transistor as shown in Figure 8-5.

In this configuration, the sensing circuit is composed of Z_1 and Q_1 with biasing components. It is similar to the sensing circuit shown in Figure 8-1b. The potentiometer R_1 adjusts

the conduction point of Q1 establishing the proper charge level. When the battery has reached the desired level, Q1 begins to conduct. This draws Q2 into conduction, and therefore shorts off Q3 which is supplying power to the alternator field. This type of regulator offers greater sensitivity with an increase in cost.

Unijunction-Zener Sense Circuits

Unijunction transistor oscillator circuits can be made GO-NO GO voltage sensitive by incorporating a zener diode clamp. The UJT operates on the criterion: under proper biasing conditions the emitter-base one junction will breakover when the emitter voltage reaches a specific value given by the equation:

$$V_p = \eta V_{BB} + V_D \quad (8-1)$$

where:

V_p = peak point emitter voltage

η = intrinsic stand-off ratio for the device

V_{BB} = interbase voltage, from base two to base one

V_D = emitter to base one diode forward junction drop.

Obviously, if we provide a voltage clamp in the circuit such that the conditions of equation 8-1 are met only with restriction on the input, the circuit becomes voltage sensitive. There are two basic techniques used in clamping UJT relaxation oscillators. They are shown in Figure 8-6 and Figure 8-7.

The circuit in Figure 8-6 is that of a clamped emitter type. As long as the input voltage V_{IN} is low enough so that V_p does not exceed the Zener voltage V_Z , the circuit will generate output pulses. At some given point, the required V_p for triggering will exceed V_Z . Since V_p is clamped at V_Z , the circuit will not oscillate. This, in essence, means the circuit is GO as long as V_{IN} is below a certain level, and NO GO above the critical clamp point.

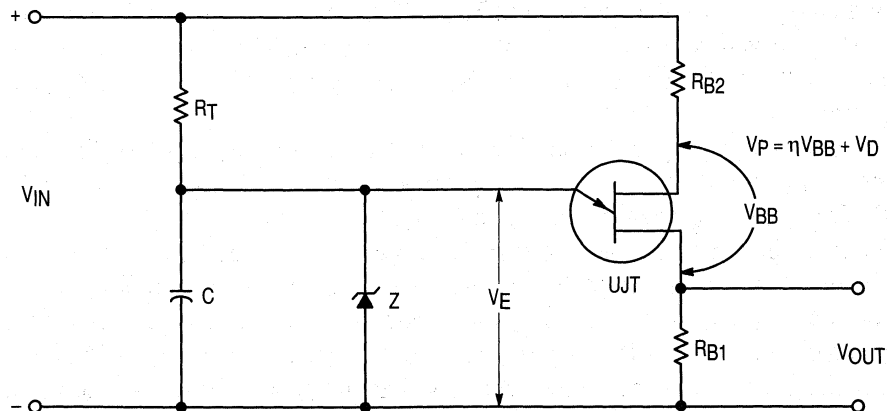

Figure 8-6. UJT Oscillator, GO — NO GO Output,
GO for Low V_{IN} — NO GO for High V_{IN}

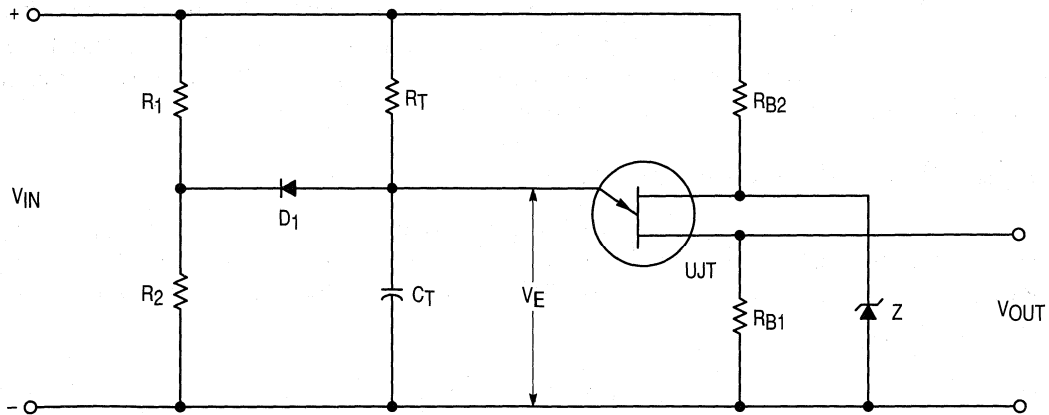

Figure 8-7. UJT — NO GO Output, NO GO for Low V_{IN} — GO for High V_{IN}

The circuit of Figure 8-7, is a clamped base UJT oscillator. In this circuit V_{BB} is clamped at a voltage V_Z and the emitter tied to a voltage dividing network by a diode D_1 . When the input voltage is low, the voltage drop across R_2 is less than V_p . The forward biased diode holds the emitter below the trigger level. As the input increases, the R_2 voltage drop approaches V_p . The diode D_1 becomes reversed biased and, the UJT triggers. This phenomenon establishes the operating criterion that the circuit is NO GO at a low input and GO at an input higher than the clamp voltage. Therefore, the circuits in Figures 8-6 and 8-7 are both input voltage sensitive, but have opposite input requirements for a GO condition. To illustrate the usefulness of the clamped UJT relaxation oscillators, the following two sections show them being used in practical applications.

Battery Voltage Sensitive SCR Charger

6 A clamped emitter unijunction sensing circuit of the type shown in Figure 8-6 makes a very good battery charger (illustrated in Figure 8-8). This circuit will not operate until the battery to be charged is properly connected to the charger. The battery voltage controls the charger and will dictate its operation. When the battery is properly charged, the charger will cease operation.

The battery charging current is obtained through the controlled rectifier. Triggering pulses for the controlled rectifier are generated by unijunction transistor relaxation oscillator (Figure 8-9). This oscillator is activated when the battery voltage is low.

While operating, the oscillator will produce pulses in the pulse transformer connected across the resistance, R_{GC} (R_{GC} represents the gate-to-cathode resistance of the controlled rectifier), at a frequency determined by the resistance, capacitance, R.C. time delay circuit.

Since the base-to-base voltage on the unijunction transistor is derived from the charging battery, it will increase as the battery charges. The increase in base-to-base voltage of the unijunction transistor causes its peak point voltage (switching voltage) to increase. These waveforms are sketched in Figure 8-9 (this voltage increase will tend to change the pulse repetition rate, but this is not important).

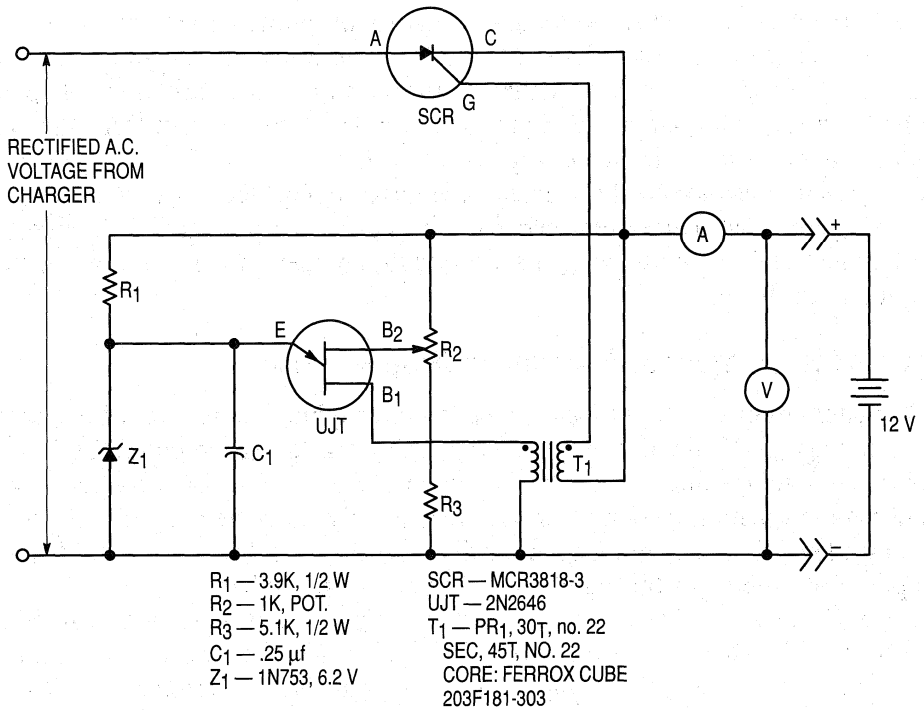

Figure 8-8. 12 Volt Battery Charger Control

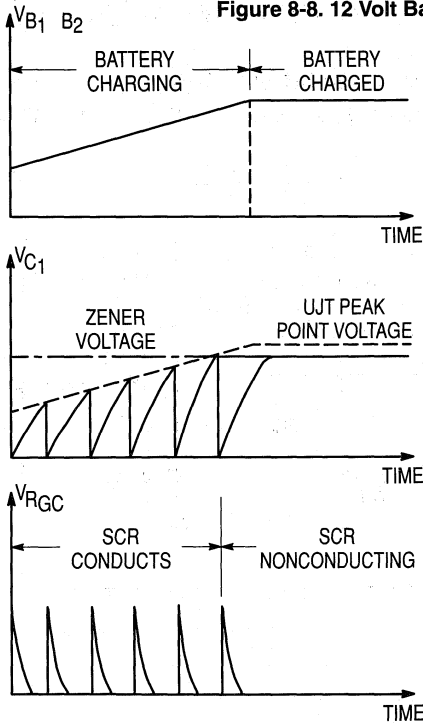
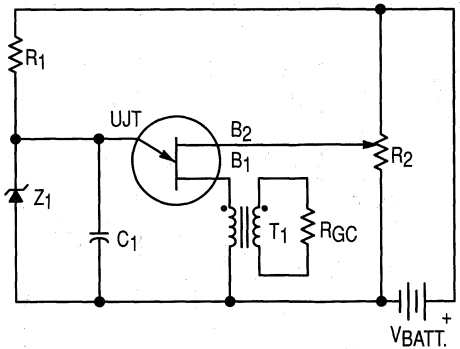

Figure 8-9. UJT Relaxation Oscillator Operation



When the peak point voltage (switching voltage) of the unijunction transistor exceeds the breakdown voltage of the Zener diode, Z₁, connected across the delay circuit capacitor, C₁, the unijunction transistor ceases to oscillate. If the relaxation oscillator does not operate, the controlled rectifier will not receive trigger pulses and will not conduct. This indicates that the battery has attained its desired charge as set by R₂.

The unijunction cannot oscillate unless a voltage somewhere between 3 volts and the cutoff setting is present at the output terminals with polarity as indicated. Therefore, the SCR cannot conduct under conditions of a short circuit, an open circuit, or a reverse polarity connection to the battery.

Alternator Regulator for Permanent Magnet Field

In alternator circuits such as those of an outboard engine, the field may be composed of a permanent magnet. This increases the problem of regulating the output by limiting the control function to opening or shorting the output. Because of the high reactance source of most alternators, opening the output circuit will generally stress the bridge rectifiers to a very high voltage level. It is, therefore, apparent that the best control function would be shorting the output of the alternator for regulation of the charge to the battery.

Figure 8-10 shows a permanent magnet alternator regulator designed to regulate a 15 ampere output. The two SCRs are connected on the ac side of the bridge, and short out the alternator when triggered by the unijunction voltage sensitive triggering circuit. The sensing circuit is of the type shown in Figure 8-7. The shorted output does not appreciably increase the maximum output current level.

A single SCR could be designed into the dc side of the bridge. However, the rapid turn-off requirement of this type of circuit at high alternator speeds makes this circuit impractical.

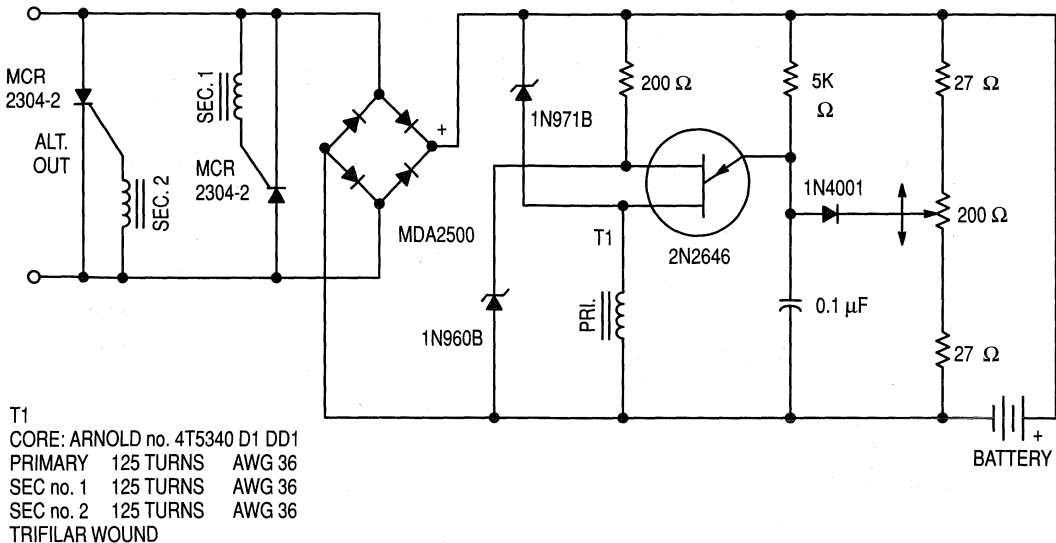

Figure 8-10. Permanent Magnet Field Alternator Regulator

The unijunction circuit in Figure 8-10 will not oscillate until the input voltage level reaches the voltage determined by the intrinsic standoff ratio. The adjustable voltage divider will calibrate the circuit. The series diode in the voltage divider circuit will compensate for the emitter-base-one diode temperature change, consequently, temperature compensation is necessary only for the zener diode temperature changes.

Due to the delay in charging the unijunction capacitor, when the battery is disconnected the alternator voltage will produce high stress voltage on all components before the SCRs will be fired. The 1N971B Zener was included in the circuit to provide a trigger pulse to the SCRs as soon as the alternator output voltage level approaches 30 volts.

Zener-Resistor Voltage Sensing

A simple but useful sense circuit can be made from just a Zener diode and resistor such as shown in Figure 8-11.

Whenever the applied signal exceeds the specific Zener voltage V_Z , the difference appears across the dropping resistor R . This level dependent differential voltage can be used for level detection, magnitude reduction, wave shaping, etc. An illustrative application of the simple series Zener sensor is shown in Figure 8-12, where the resistor drop is monitored with a voltmeter.

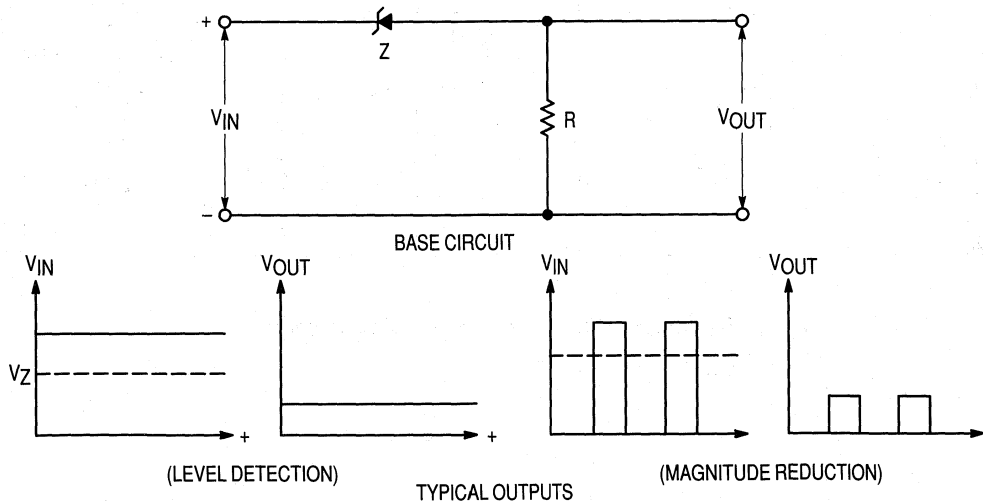

Figure 8-11. Zener-Resistor Voltage Sensitive Circuit

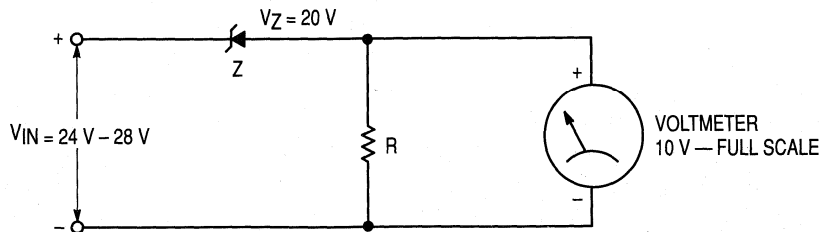

Figure 8-12. Improving Meter Resolution

If, for example, the input is variable from 24 to 28 volts, a 30 voltmeter would normally be required. Unfortunately, a 4 volt range of values on a 30 volt scale utilizes only 13.3% of the meter movement — greatly limiting the accuracy with which the meter can be read. By employing a 20 volt zener, one can use a 10 voltmeter instead of the 30 volt unit, thereby utilizing 40% of the meter movement instead of 13.3% with a corresponding increase in accuracy and readability. For ultimate accuracy a 24 volt zener could be combined with a 5 voltmeter. This combination would have the disadvantage of providing little room for voltage fluctuations, however.

In Figure 8-13, a number of sequentially higher-voltage Zener sense circuits are cascaded to actuate transistor switches. As each goes into avalanche its respective switching transistor is turned on, actuating the indicator light for that particular voltage level. This technique can be expanded and modified to use the zener sensors to actuate some form of logic system.

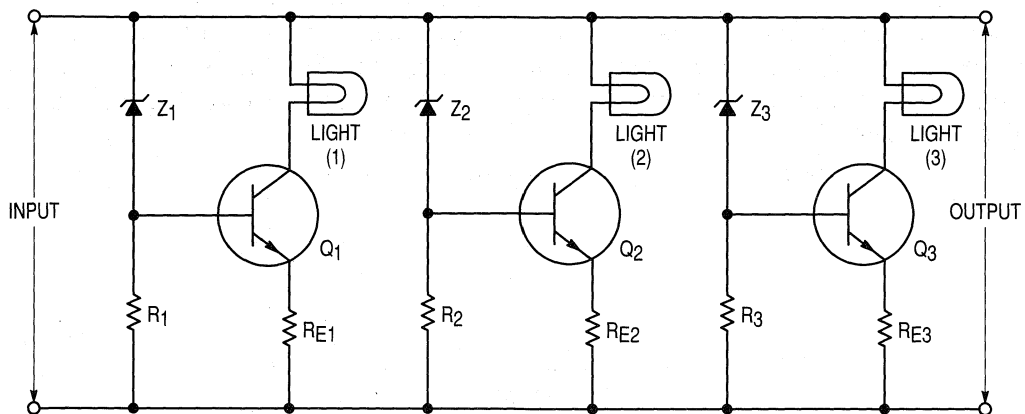

Figure 8-13. Sequential Voltage Level Indicator

CHAPTER 9: MISCELLANEOUS APPLICATIONS OF ZENER TYPE DEVICES

Introduction

Many of the commonly used applications of zener diodes have been illustrated in some depth in the preceding chapters. This chapter shows how a zener diode may be used in some rarer applications such as voltage translators, to provide constant current, wave shaping, frequency control and synchronized SCR triggers.

The circuits used in this chapter are not intended as finished designs since only a few component values are given. The intent is to show some general broad ideas and not specific designs aimed at a narrow use.

Frequency Regulation of a DC to AC Inverter

Zener diodes are often used in control circuits, usually to control the magnitude of the output voltage or current. In this unusual application, however, the zener is used to control the output frequency of a current feedback inverter. The circuit is shown in Figure 9-1.

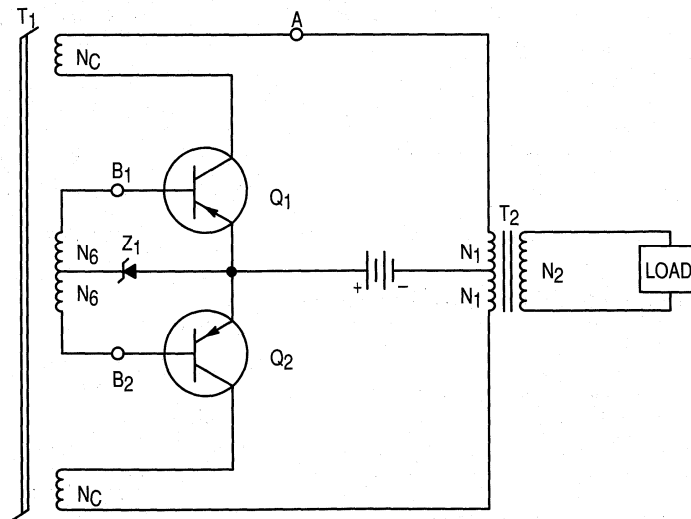

Figure 9-1. Frequency Controlled Current Feedback Inverter

The transformer T1 functions as a current transformer providing base current $I_B = (N_C/N_B)I_C$. Without the zener diode, the voltage across N_B windings of the timing transformer T1 is clamped to V_{BE} of the ON device, giving an inverter frequency of

$$f = \frac{V_{BE} \times 10^8}{4B_S I_A N_B}$$

where $BS1A1$ is the flux capacity of $T1$ transformer core. The effect on output frequency of V_{BE} variations due to changing load or temperature can be reduced by using a zener diode in series with V_{BE} as shown in Figure 9-1. For this circuit, the output frequency is given by

$$f = \frac{(V_{BE} + V_Z) \times 10^8}{4BS1A1NB}$$

If V_{BE} is small compared to the zener voltage V_Z , good frequency accuracy is possible. For example, with $V_Z = 9.1$ volts, a 40 Watt inverter using 2N3791 transistors (operating from a 12 volt supply), exhibited frequency regulation of $\pm 2\%$ with $\pm 25\%$ load variation.

Care should be taken not to exceed $V(BR)EBO$ of the non-conducting transistor, since the reverse emitter-base voltage will be twice the introduced series voltage, plus V_{BE} of the conducting device.

Transformer $T2$ should not saturate at the lowest inverter frequency.

Inverter starting is facilitated by placing a resistor from point A to $B1$ or a capacitor from A to $B2$.

Simple Square Wave Generator

The zener diode is widely used in wave shaping circuits; one of its best known applications is a simple square wave generator. In this application, the zener clips sinusoidal waves producing a square wave such as shown in Figure 9-2a. In order to generate a wave with reasonably vertical sides, the ac voltage must be considerably higher than the zener voltage.

Clipper diodes with opposing junctions built into the device are ideal for applications of the type shown in Figure 9-2b.

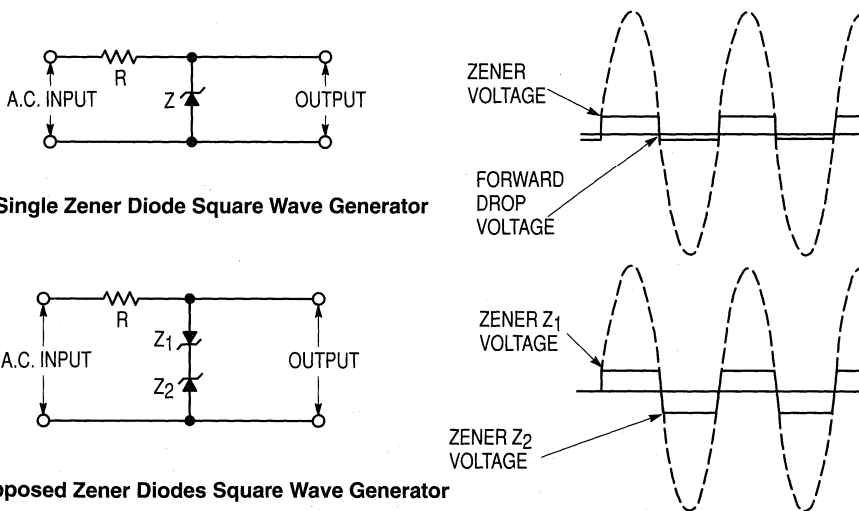

Figure 9-2. Zener Diode Square Wave Generator

CONTENTS

	PAGE
AN784 TRANSIENT POWER CAPABILITY OF ZENER DIODES	7-2-1
AN843 A REVIEW OF TRANSIENTS AND THEIR MEANS OF SUPPRESSION	7-3-1
ARTICLE SOME STRAIGHT TALK ABOUT MOSORBS TRANSIENT VOLTAGE SUPPRESSORS	7-4-1
AR450 CHARACTERIZING OVERVOLTAGE TRANSIENT SUPPRESSORS	7-5-1
ARTICLE MEASUREMENT OF ZENER VOLTAGE TO THERMAL EQUILIBRIUM WITH PULSED TEST CIRCUIT	7-6-1
ARTICLE DESIGN CONSIDERATIONS AND PERFORMANCE OF MOTOROLA TEMPERATURE-COMPENSATED ZENER (REFERENCE) DIODES	7-7-1

TRANSIENT POWER CAPABILITY OF ZENER DIODES

AN784
REV. 1

Prepared by
Applications Engineering and
Jerry Wilhardt, Product Engineer — Industrial and Hi-Rel Zener Diodes

INTRODUCTION

Because of the sensitivity of semiconductor components to voltage transients in excess of their ratings, circuits are often designed to inhibit voltage surges in order to protect equipment from catastrophic failure. External voltage transients are imposed on power lines as a result of lightning strikes, motors, solenoids, relays or SCR switching circuits, which share the same ac source with other equipment. Internal transients can be generated within a piece of equipment by rectifier reverse recovery transients, switching of loads or transformer primaries, fuse blowing, solenoids, etc. The basic relation, $v = L di/dt$, describes most equipment developed transients.

ZENER DIODE CHARACTERISTICS

Zener diodes, being nearly ideal clippers (that is, they exhibit close to an infinite impedance below the clipping level and close to a short circuit above the clipping level), are often used to suppress transients. In this type of application, it is important to know the power capability of the zener for short pulse durations, since they are intolerant of excessive stress.

Some Motorola data sheets such as the ones for devices shown in Table 1 contain short pulse surge capability. However, there are many data sheets that do not contain this data and Figure 1 is presented here to supplement this information.

Table 1. Transient Suppressor Diodes			
Series Numbers	Steady State Power	Package	Description
1N4728	1 W	DO-41	Double Slug Glass
1N6267	5 W	Case 41A-02	Axial Lead Plastic
1N5333A	5 W	Case 17	Surmetic 40
1N746/957 A/4371	400 mW	DO-35	Double Slug Glass
1N5221A	500 mW	DO-35	Double Slug Glass

Some data sheets have surge information which differs slightly from the data shown in Figure 1. A variety of reasons exist for this:

1. The surge data may be presented in terms of actual surge power instead of nominal power.

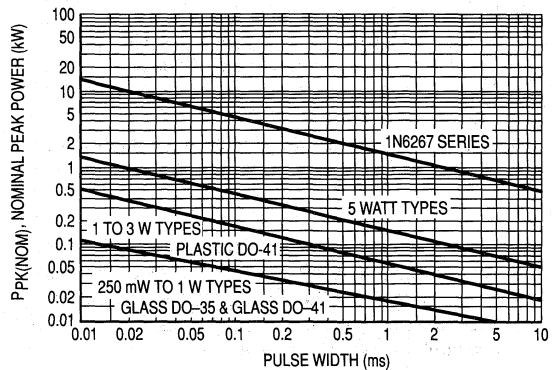

Figure 1. Peak Power Ratings of Zener Diodes

Power is defined as $V_Z(\text{NOM}) \times I_Z(\text{PK})$ where $V_Z(\text{NOM})$ is the nominal zener voltage measured at the low test current used for voltage classification.

2. Product improvements have occurred since the data sheet was published.

3. Larger dice are used, or special tests are imposed on the product to guarantee higher ratings than those shown on Figure 1.

4. The specifications may be based on a JEDEC registration or part number of another manufacturer.

The data of Figure 1 applies for non-repetitive conditions and at a lead temperature of 25°C. If the duty cycle increases, the peak power must be reduced as indicated by the curves of Figure 2. Average power must be derated as the lead or ambient temperature rises above 25°C. The average power derating curve normally given on data sheets may be normalized and used for this purpose.

At first glance the derating curves of Figure 2 appear to be in error as the 10 ms pulse has a higher derating factor than the 10 μs pulse. However, when the derating factor for a given pulse of Figure 2 is multiplied by the peak power value of Figure 1 for the same pulse, the results follow the expected trend.

When it is necessary to use a zener close to surge ratings, and a standard part having guaranteed surge limits is not suitable, a special part number may be created having a surge limit as part of the specification. Contact your nearest Motorola OEM sales office for capability, price, delivery, and minimum order criteria.

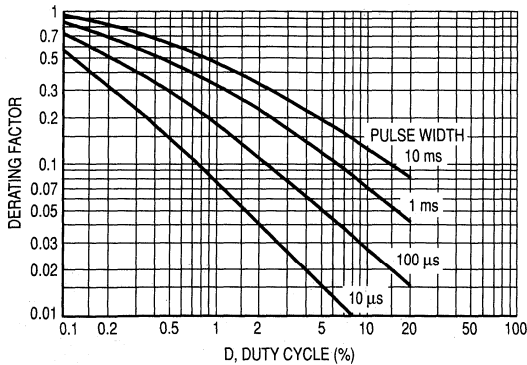

Figure 2. Typical Derating Factor for Duty Cycle

MATHEMATICAL MODEL

Since the power shown on the curves is not the actual transient power measured, but is the product of the peak current measured and the nominal zener voltage measured at the current used for voltage classification, the peak current can be calculated from:

$$I_{Z(PK)} = \frac{P(PK)}{V_Z(NOM)} \quad (1)$$

The peak voltage at peak current can be calculated from:

$$V_Z(PK) = F_C \times V_Z(NOM) \quad (2)$$

where F_C is the clamping factor. The clamping factor is approximately 1.20 for all zener diodes when operated at their pulse power limits. For example, a 5 watt, 20 volt zener can be expected to show a peak voltage of 24 volts regardless of whether it is handling 450 watts for 0.1 ms or 50 watts for 10 ms. This occurs because the voltage is a function of junction temperature and IR drop. Heating of the junction is more severe at the longer pulse width, causing a higher voltage component due to temperature which is roughly offset by the smaller IR voltage component.

For modeling purposes, an approximation of the zener resistance is needed. It is obtained from:

$$R_Z(NOM) = \frac{V_Z(NOM)(F_C - 1)}{P_{PK}(NOM)V_Z(NOM)} \quad (3)$$

The value is approximate because both the clamping factor and the actual resistance are a function of temperature.

CIRCUIT CONSIDERATIONS

It is important that as much impedance as circuit constraints allow be placed in series with the zener diode and the components to be protected. The result will be a lower clipping voltage and less zener stress. A capacitor in parallel with the zener is also effective in reducing the stress imposed by very short duration transients.

To illustrate use of the data, a common application will be analyzed. The transistor in Figure 3 drives a 50 mH solenoid which requires 5 amperes of current. Without some means of clamping the voltage from the inductor when the transistor turns off, it could be destroyed.

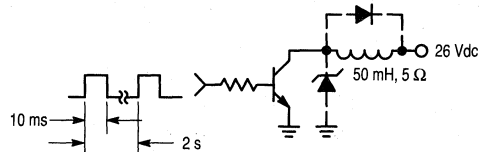

Figure 3. Circuit Example

Used to select a zener diode having the proper voltage and power capability to protect the transistor.

The means most often used to solve the problem is to connect an ordinary rectifier diode across the coil; however, this technique may keep the current circulating through the coil for too long a time. Faster switching is achieved by allowing the voltage to rise to a level above the supply before being clamped. The voltage rating of the transistor is 60 V, indicating that approximately a 50 volt zener will be required.

The peak current will equal the on-state transistor current (5 amperes) and will decay exponentially as determined by the coil L/R time constant (neglecting the zener impedance). A rectangular pulse of width L/R (0.01 sec) and amplitude of I_{PK} (5 A) contains the same energy and may be used to select a zener diode. The nominal zener power rating therefore must exceed $(5 A \times 50) = 250$ watts at 10 ms and a duty cycle of $0.01/2 = 0.5\%$. From Figure 2, the duty cycle factor is 0.62 making the single pulse power rating required equal to $250/0.62 = 403$ watts. From Figure 1, one of the 1N6267 series zeners has the required capability. The 1N6287 is specified nominally at 47 volts and should prove satisfactory.

Although this series has specified maximum voltage limits, equation 3 will be used to determine the maximum zener voltage in order to demonstrate its use.

$$R_Z = \frac{47(1.20 - 1)}{500/47} = \frac{9.4}{10.64} = 0.9\Omega$$

At 5 amperes, the peak voltage will be 4.5 volts above nominal or 51.5 volts total which is safely below the 60 volt transistor rating.

A REVIEW OF TRANSIENTS AND THEIR MEANS OF SUPPRESSION

AN843
REV. 1

Prepared by
Steve Cherniak
Applications Engineering

INTRODUCTION

One problem that most, if not all electronic equipment designers must deal with, is transient overvoltages. Transients in electrical circuits result from the sudden release of previously stored energy. Some transients may be voluntary and created in the circuit due to inductive switching, commutation voltage spikes, etc. and may be easily suppressed since their energy content is known and predictable. Other transients may be created outside the circuit and then coupled into it. These can be caused by lightning, substation problems, or other such phenomena. These transients, unlike switching transients, are beyond the control of the circuit designer and are more difficult to identify, measure and suppress.

Effective transient suppression requires that the impulse energy is dissipated in the added suppressor at a low enough voltage so the capabilities of the circuit or device will not be exceeded.

REOCCURRING TRANSIENTS

Transients may be formed from energy stored in circuit inductance and capacitance when electrical conditions in the circuit are abruptly changed.

Switching induced transients are a good example of this; the change in current ($\frac{di}{dt}$) in an inductor (L) will

generate a voltage equal to $L \frac{di}{dt}$. The energy (J) in the transient is equal to $1/2Li^2$ and usually exists as a high power impulse for a relatively short time ($J = Pt$).

If load 2 is shorted (Figure 1), devices parallel to it may be destroyed. When the fuse opens and interrupts the fault current, the slightly inductive power supply produces a transient voltage spike of $V = L \frac{di}{dt}$ with an energy content of $J = 1/2Li^2$. This transient might be beyond the voltage limitations of the rectifiers and/or load 1. Switching out a high current load will have a similar effect.

TRANSFORMER PRIMARY BEING ENERGIZED

If a transformer is energized at the peak of the line voltage (Figure 2), this voltage step function can couple to the stray capacitance and inductance of the secondary winding and generate an oscillating transient voltage whose oscillations depend on circuit inductance and capacitance. This transient's peak voltage can be up to twice the peak amplitude of the normal secondary voltage.

In addition to the above phenomena the capacitively coupled (C_S) voltage spike has no direct relationship with the turns ratio, so it is possible for the secondary circuit to see the peak applied primary voltage.

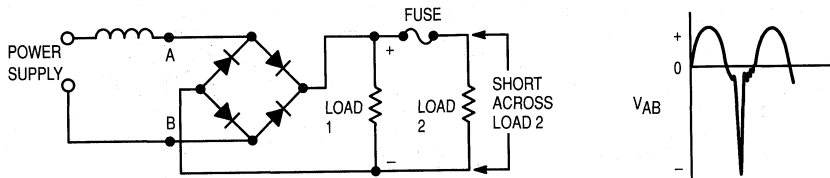

Figure 1. Load Dump with Inductive Power Supply

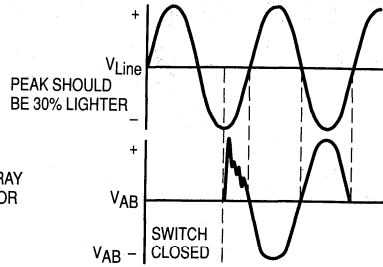
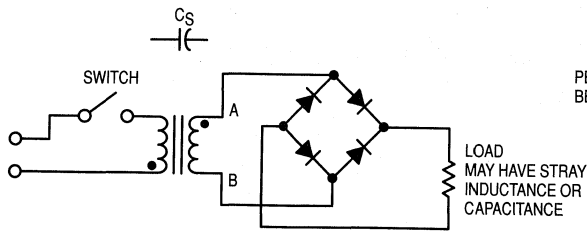

Figure 2. Situation Where Transformer Capacitance Causes a Transient

TRANSFORMER PRIMARY BEING DE-ENERGIZED

If the transformer is driving a high impedance load, transients of more than ten times normal voltage can be created at the secondary when the primary circuit of the transformer is opened during zero-voltage crossing of the ac line. This is due to the interruption of the transformer magnetizing current which causes a rapid collapse of the magnetic flux in the core. This, in turn, causes a high voltage transient to be coupled into the transformer's secondary winding (Figure 3).

Transients produced by interrupting transformers magnetizing current can be severe. These transients can destroy a rectifier diode or filter capacitor if a low impedance discharge path is not provided.

SWITCH "ARCING"

When a contact type switch opens and tries to interrupt current in an inductive circuit, the inductance tries to keep current flowing by charging stray capacitances. (See Figure 4.)

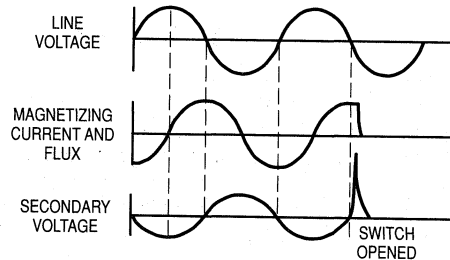
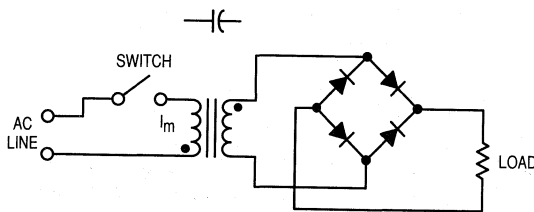

Figure 3. Typical Situation Showing Possible Transient When Interrupting Transformer Magnetizing Current

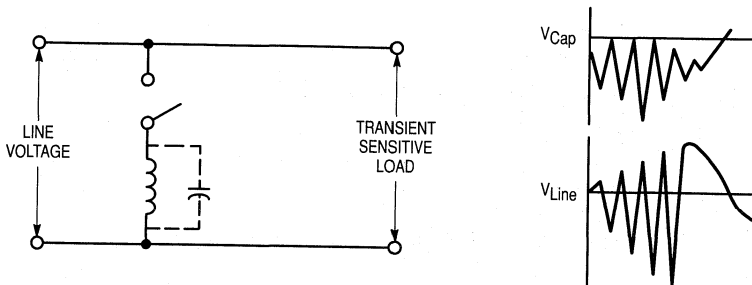

Figure 4. Transients Caused by Switch Opening

This can also happen when the switch contacts bounce open after its initial closing. When the switch is opened (or bounces open momentarily) the current that the inductance wants to keep flowing will oscillate between the stray capacitance and the inductance. When the voltage due to the oscillation rises at the contacts, breakdown of the contact gap is possible, since the switch opens (or bounces open) relatively slowly compared to the oscillation frequency, and the distance may be small enough to permit "arcing." The arc will discontinue at the zero current point of the oscillation, but as the oscillatory voltage builds up again and the contacts move further apart, each arc will occur at a higher voltage until the contacts are far enough apart to interrupt the current.

WAVESHAPES OF SURGE VOLTAGES

Indoor Waveshapes

Measurements in the field, laboratory, and theoretical calculations indicate that the majority of surge voltages in indoor low-voltage power systems have an oscillatory waveshape. This is because the voltage surge excites the natural resonant frequency of the indoor wiring system. In addition to being typically oscillatory, the surges can also have different amplitudes and waveshapes in the various places of the wiring system. The resonant frequency can range from about 5 kHz to over 500 kHz. A 100 kHz frequency is a realistic value for a typical surge voltage for most residential and light industrial ac wire systems.

The waveshape shown in Figure 5 is known as an "0.5 μ s - 100 kHz ring wave." This waveshape is reasonably representative of indoor low-voltage (120 V - 240 V) wiring system transients based on measurements conducted by several independent organizations. The waveshape is defined as rising from 10% to 90% of its final amplitude in 0.5 μ s, then decays while oscillating at 100 kHz, each peak being 60% of the preceding one.

The fast rise portion of the waveform can induce the effects associated with non-linear voltage distribution in windings or cause dv/dt problems in semiconductors. Shorter rise times can be found in transients but they are

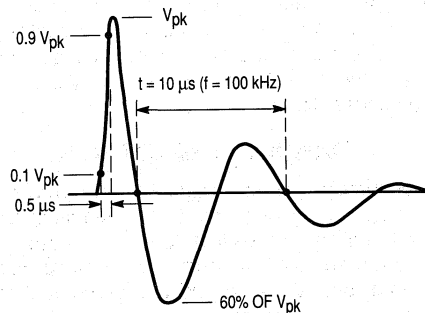

Figure 5. 0.5 μ s 100 kHz Ring Wave

lengthened as they propagate into the wiring system or reflected from wiring discontinuities.

The oscillating portion of the waveform produces voltage polarity reversal effects. Some semiconductors are sensitive to polarity changes or can be damaged when forced into or out of conduction (i.e. reverse recovery of rectifier devices). The sensitivity of some semiconductors to the timing and polarity of a surge is one of the reasons for selecting this oscillatory waveform to represent actual conditions.

Outdoor Locations

Both oscillating and unidirectional transients have been recorded in outdoor environments (service entrances and other places nearby). In these locations substantial energy is still available in the transient, so the waveform used to model transient conditions outside buildings must contain greater energy than one used to model indoor transient surges.

Properly selected surge suppressors have a good reputation of successful performance when chosen in conjunction with the waveforms described in Figure 6. The recommended waveshape of $1.2 \times 50 \mu$ s (1.2 μ s is associated with the transients rise time and the 50 μ s is the time it takes for the voltage to drop to $1/2V_{pk}$) for the open circuit voltage and $8 \times 20 \mu$ s for the short circuit current are as defined in IEEE standard 28-ANSI Standard C62.1 and can be considered a realistic representation of an outdoor transients waveshape.

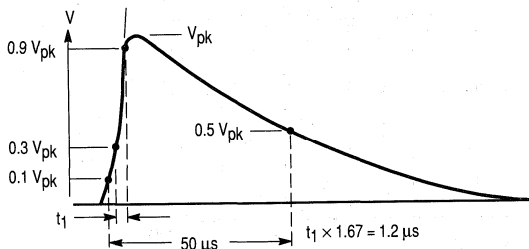

(a) Open-Circuit Voltage Waveform

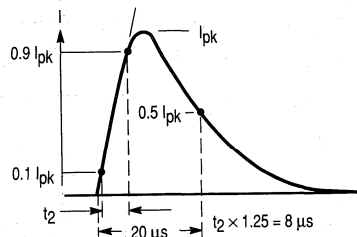

(b) Discharge Current Waveform

Figure 6. Unidirectional Wave Shapes

The type of device under test determines which wave-shape in Figure 6 is more appropriate. The voltage waveform is normally used for insulation voltage withstand tests and the current waveform is usually used for discharge current tests.

RANDOM TRANSIENTS

The source powering the circuit or system is frequently the cause of transient induced problems or failures. These transients are difficult to deal with due to their nature; they are totally random and it is difficult to define their amplitude, duration and energy content. These transients are generally caused by switching parallel loads on the same branch of a power distribution system and can also be caused by lightning.

AC POWER LINE TRANSIENTS

Transients on the ac power line range from just above normal voltage to several kV. The rate of occurrence of transients varies widely from one branch of a power distribution system to the next, although low-level transients occur more often than high-level surges.

Data from surge counters and other sources is the basis for the curves shown in Figure 7. This data was taken from unprotected (no voltage limiting devices) circuits meaning that the transient voltage is limited only by the sparkover distance of the wires in the distribution system.

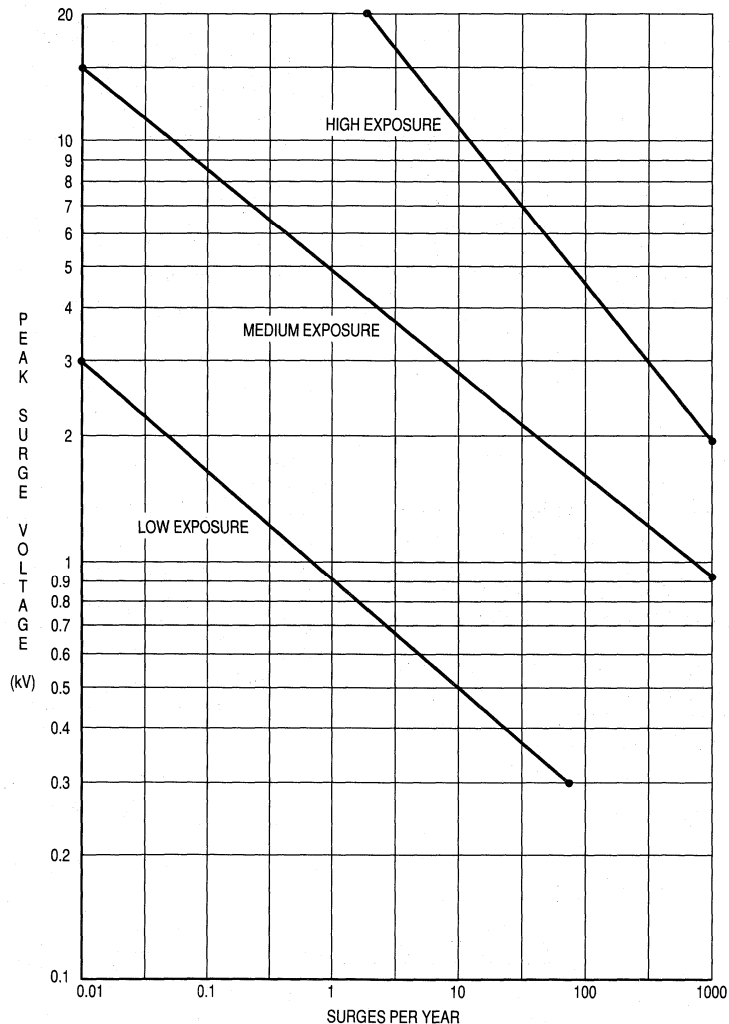

Figure 7. Peak Surge Voltage versus Surges per Year*

*EIA paper, P587.1/F, May, 1979, Page 10



The low exposure portion of the set of curves is data collected from systems with little load-switching activity that are located in areas of light lightning activity.

Medium exposure systems are in areas of frequent lightning activity with a severe switching transient problem.

High exposure systems are rare systems supplied by long overhead lines which supply installations that have high sparkover clearances and may be subject to reflections at power line ends.

When using Figure 7 it is helpful to remember that peak transient voltages will be limited to approximately 6 kV in indoor locations due to the spacing between conductors using standard wiring practices.

TRANSIENT ENERGY LEVELS AND SOURCE IMPEDANCE

The energy contained in a transient will be divided between the transient suppressor and the source impedance of the transient in a way that is determined by the two impedances. With a spark-gap type suppressor, the low impedance of the Arc after breakdown forces most of the transient's energy to be dissipated elsewhere, e.g. in a current limiting resistor in series with the spark-gap and/or in the transient's source impedance. Voltage clamping suppressors (e.g. zeners, mov's, rectifiers operating in the breakdown region) on the other hand absorb a large portion of the transient's surge energy. So it is necessary that a realistic assumption of the transient's source impedance be made in order to be able to select a device with an adequate surge capability.

The 100 kHz "Ring Wave" shown in Figure 5 is intended to represent a transient's waveshape across an open circuit. The waveshape will change when a load is connected and the amount of change will depend on the transient's source impedance. The surge suppressor must be able to withstand the current passed through it from the surge source. An assumption of too high a surge impedance (when testing the suppressor) will not

subject the device under test to sufficient stresses, while an assumption of too low a surge impedance may subject it to an unrealistically large stress; there is a trade-off between the size (cost) of the suppressor and the amount of protection obtained.

In a building, the transient's source impedance increases with the distance from the electrical service entrance, but open circuit voltages do not change very much throughout the structure since the wiring does not provide much attenuation. There are three categories of service locations that can represent the majority of locations from the electrical service entrance to the most remote wall outlet. These are listed below. Table 1 is intended as an aid for the preliminary selection of surge suppression devices, since it is very difficult to select a specific value of source impedance.

Category I: Outlets and circuits a "long distance" from electrical service entrance. Outlets more than 10 meters from Category II or more than 20 meters from Category III (wire gauge #14 - #10)

Category II: Major bus lines and circuits a "short distance" from electrical service entrance. Bus system in industrial plants. Outlets for heavy duty appliances that are "close" to the service entrance.

- Distribution panel devices.
- Commercial building lighting systems.

Category III. Electrical service entrance and outdoor locations.

- Power line between pole and electrical service entrance.
- Power line between distribution panel and meter.
- Power line connection to additional near-by buildings.
- Underground power lines leading to pumps, filters, etc.

Categories I and II in Table 1 correspond to the extreme range of the "medium exposure" curve in Figure 7. The surge voltage is limited to approximately 6 kV due to the sparkover spacing of indoor wiring.

Table 1. Surge Voltages and Currents Deemed to Represent the Indoor Environment Depending Upon Location

Category	Waveform	Surge Voltage ¹	Surge Current ²	Energy (Joules) Dissipated in a Suppressor with a Clamping Voltage of ³		
				250 V	500 V	1000 V
I	0.5 μ s 100 kHz Ring Wave	6 kV	200 A	0.4	0.8	1.6
II	0.5 μ s 100 kHz Ring Wave	6 kV	500 A	1	2	4
	1.2 \times 50 μ s 8 \times 20 μ s	6 kV	3 kA	20	40	80
III	1.2 \times 50 μ s 8 \times 20 μ s	10 kV or more	10 kA or more			

Notes: 1. Open Circuit voltage
 2. Discharge current of the surge (not the short circuit current of the power system)
 3. The energy a suppressor will dissipate varies in proportion with the suppressor's clamping voltage, which can be different with different system voltages (assuming the same discharge current).

he discharge currents of Category II were obtained from simulated lightning tests and field experience with suppressor performance.

The surge currents in Category I are less than in Category II because of the increase in surge impedance due to the fact that Category I is further away from the service entrance.

Category III can be compared to the "High Exposure" situation in Figure 7. The limiting effect of sparkover is not available here so the transient voltage can be quite large.

LIGHTNING TRANSIENTS

There are several mechanisms in which lightning can produce surge voltages on power distribution lines. One of them is a direct lightning strike to a primary (before the substation) circuit. When this high current, that is injected into the power line, flows through ground resistance and the surge impedance of the conductors, very large transient voltages will be produced. If the lightning misses the primary power line but hits a nearby object the lightning discharge may also induce large voltage transients on the line. When a primary circuit surge arrester operates and limits the primary voltage the rapid dv/dt produced will effectively couple transients to the secondary circuit through the capacitance of the transformer (substation) windings in addition to those coupled into the secondary circuit by normal transformer action. If lightning struck the secondary circuit directly, very high currents may be involved which would exceed

the capability of conventional surge suppressors. Lightning ground current flow resulting from nearby direct to ground discharges can couple onto the common ground impedance paths of the grounding networks also causing transients.

AUTOMOTIVE TRANSIENTS

Transients in the automotive environment can range from the noise generated by the ignition system and the various accessories (radio, power window, etc.) to the potentially destructive high energy transients caused by the charging (alternator/regulator) system. The automotive "Load Dump" can cause the most destructive transients; it is when the battery becomes disconnected from the charging system during high charging rates. This is not unlikely when one considers bad battery connections due to corrosion or other wiring problems. Other problems can exist such as steady state overvoltages caused by regulator failure or 24 V battery jump starts. There is even the possibility of incorrect battery connection (reverse polarity).

Capacitive and/or inductive coupling in wire harnesses as well as conductive coupling (common ground) can transmit these transients to the inputs and outputs of automotive electronics.

The Society of Automotive Engineers (SAE) documented a table describing automotive transients (see Table 2) which is useful when trying to provide transient protection.

Table 2. Typical Transients Encountered in the Automotive Environment

Length of Transient	Cause	Energy Capability	Possible Frequency of Application
		Voltage Amplitude	
Steady State	Failed Voltage Regulator	∞	Infrequent
		+18 V	
5 Minutes	Booster starts with 24 V battery	∞	Infrequent
		± 24 V	
4.5–100 ms	Load Dump — i.e., disconnection of battery during high charging rates	≥ 10 J	Infrequent
		≤ 125 V	
≤ 0.32 s	Inductive Load Switching Transient	< 1 J	Often
		-300 V to +80 V	
≤ 0.2 s	Alternator Field Decay	< 1 J	Each Turn-Off
		-100 V to -40 V	
90 ms	Ignition Pulse Disconnected Battery	< 0.5 J	≤ 500 Hz Several Times in vehicle life
		≤ 75 V	
1 ms	Mutual Coupling in Harness	< 1 J	Often
		≤ 200 V	
15 μ s	Ignition Pulse Normal	< 0.001 J	≤ 500 Hz Continuous
		3 V	
	Accessory Noise	≤ 1.5 V	50 Hz to 10 kHz
	Transceiver Feedback	≈ 20 mV	R.F.

Considerable variation has been observed while gathering data on automobile transients. All automobiles have their electrical systems set up differently and it is not the intent of this paper to suggest a protection level that is required. There will always be a trade-off between cost of the suppressor and the level of protection obtained. The concept of one master suppressor placed on the main power lines is the most cost-effective scheme possible since individual suppressors at the various electronic devices will each have to suppress the largest transient that is likely to appear (Load Dump), hence each individual suppressor would have to be the same size as the one master suppressor since it is unlikely for several suppressors to share the transient discharge.

There will, of course, be instances where a need for individual suppressors at the individual accessories will be required, depending on the particular wiring system or situation.

TRANSIENT SUPPRESSOR TYPES

Carbon Block Spark Gap

This is the oldest and most commonly used transient suppressor in power distribution and telecommunication systems. The device consists of two carbon block electrodes separated by an air gap, usually 3 to 4 mils apart. One electrode is connected to the system ground and the other to the signal cable conductor. When a transient over-voltage appears, its energy is dissipated in the arc that forms between the two electrodes, a resistor in series with the gap, and also in the transient's source impedance, which depends on conductor length, material and other parameters.

The carbon block gap is a fairly inexpensive suppressor but it has some serious problems. One is that it has a relatively short service life and the other is that there are large variations in its arcing voltage. This is the major problem since a nominal 3 mil gap will arc anywhere from 300 to 1000 volts. This arcing voltage variation limits its use mainly to primary transient suppression with more accurate suppressors to keep transient voltages below an acceptable level.

Gas Tubes

The gas tube is another common transient suppressor, especially in telecommunication systems. It is made of two metallic conductors usually separated by 10 to 15 mils encapsulated in a glass envelope which is filled with several gases at low pressure. Gas tubes have a higher current carrying capability and longer life than carbon block gaps. The possibility of seal leakage and the resultant loss of protection has limited the use of these devices.

Selenium Rectifiers

Selenium transient suppressors are selenium rectifiers used in the reverse breakdown mode to clamp volt-

age transients. Some of these devices have self-healing properties which allows the device to survive energy discharges greater than their maximum capability for a limited number of surges. Selenium rectifiers do not have the voltage clamping capability of zener diodes. This is causing their usage to become more and more limited.

METAL OXIDE VARISTORS (MOV'S)

An MOV is a non-linear resistor which is voltage dependent and has electrical characteristics similar to back-to-back zener diodes. As its name implies it is made up of metal oxides, mostly zinc oxide with other oxides added to control electrical characteristics. MOV characteristics are compared to back-to-back zeners in Photos 2 through 7.

When constructing MOV's the metal oxides are sintered at high temperatures to produce a polycrystalline structure of conductive zinc oxide separated by highly resistive intergranular boundaries. These boundaries are the source of the MOV's non-linear electrical behavior.

MOV electrical characteristics are mainly controlled by the physical dimensions of the polycrystalline structure since conduction occurs between the zinc oxide grains and the intergranular boundaries which are distributed throughout the bulk of the device.

The MOV polycrystalline body is usually formed into the shape of a disc. The energy rating is determined by the device's volume, voltage rating by its thickness, and current handling capability by its area. Since the energy dissipated in the device is spread throughout its entire metal oxide volume, MOV's are well suited for single shot high power transient suppression applications where good clamping capability is not required.

The major disadvantages with using MOV's are that they can only dissipate relatively small amounts of average power and are not suitable for many repetitive applications. Another drawback with MOV's is that their voltage clamping capability is not as good as zeners, and is insufficient in many applications.

Perhaps the major difficulty with MOV's is that they have a limited life time even when used below their maximum ratings. For example, a particular MOV with a peak current handling capability of 1000 A has a lifetime of about 1 surge at 1000 A_{pk}, 100 surges at 100 A_{pk} and approximately 1000 surges at 65 A_{pk}.

TRANSIENT SUPPRESSION USING ZENERS

Zener diodes exhibit a very high impedance below the zener voltage (V_Z), and a very low impedance above V_Z . Because of these excellent clipping characteristics, the zener diode is often used to suppress transients. Zeners are intolerant of excessive stress so it is important to know the power handling capability for short pulse durations.

Most zeners handle less than their rated power during normal applications and are designed to operate most effectively at this low level. Zener transient suppressors such as the Motorola 1N6267 Mosorb series are designed to take large, short duration power pulses.

This is accomplished by enlarging the chip and the effective junction area to withstand the high energy surges. The package size is usually kept as small as possible to provide space efficiency in the circuit layout, and since the package does not differ greatly from other standard zener packages, the steady state power dissipation does not differ greatly.

Some data sheets contain information on short pulse surge capability. When this information is not available for Motorola devices, Figure 8 can be used. This data applies for non-repetitive conditions with a lead temperature of 25°C.

It is necessary to determine the pulse width and peak power of the transient being suppressed when using Figure 8. This can be done by taking whatever waveform the transient is and approximating it with a rectangular pulse with the same peak power. For example, an exponential discharge with a 1 ms time constant can be approximated by a rectangular pulse 1 ms wide that has the same peak power as the transient. This would be a better approximation than a rectangular pulse 10 ms wide with a correspondingly lower amplitude. This is because the heating effects of different pulse width lengths affect the power handling capability, as can be seen by Figure 8. This also represents a conservative approach because the exponential discharge will contain $\approx 1/2$ the energy of a rectangular pulse with the same pulse width and amplitude.

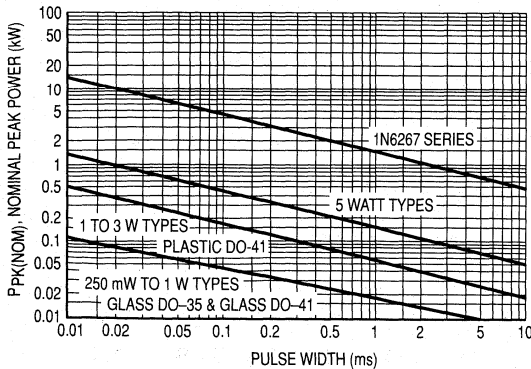

Figure 8. Peak Power Ratings of Zener Diodes

When used in repetitive applications, the peak power must be reduced as indicated by the curves of Figure 9. Average power must be derated as the lead or ambient temperature exceeds 25°C. The power derating curve normally given on data sheets can be normalized and used for this purpose.

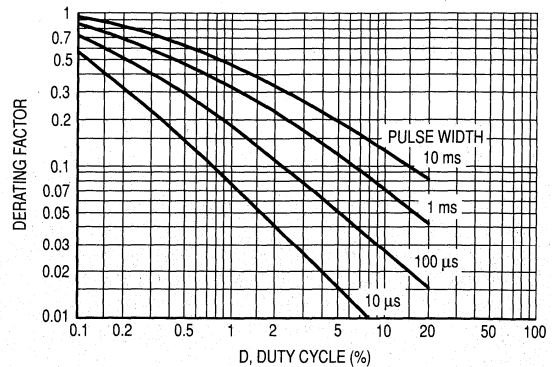

Figure 9. Typical Derating Factor for Duty Cycle

The peak zener voltage during the peak current of the transient being suppressed can be related to the nominal zener voltage (Eqtn 1) by the clamping factor (F_C).

$$\text{Eqtn 1: } V_Z(\text{pK}) = F_C (V_Z(\text{nom}))$$

Unless otherwise specified F_C is approximately 1.20 for zener diodes when operated at their pulse power limits.

For example, a 5 watt, 20 volt zener can be expected to show a peak voltage of 24 volts regardless of whether it is handling 450 watts for 0.1 ms or 50 watts for 10 ms. (See Figure 8.)

This occurs because the zener voltage is a function of both junction temperature and IR drop. Longer pulse widths cause a greater junction temperature rise than short ones; the increase in junction temperature slightly increases the zener voltage. This increase in zener voltage due to heating is roughly offset by the fact that longer pulse widths of identical energy content have lower peak currents. This results in a lower IR drop (zener voltage drop) keeping the clamping factor relatively constant with various pulse widths of identical energy content.

An approximation of zener impedance is also helpful in the design of transient protection circuits. The value of $R_Z(\text{nom})$ (Eqtn 2) is approximate because both the clamping factor and the actual resistance is a function of temperature.

$$\text{Eqtn 2: } R_Z(\text{nom}) = \frac{V_Z^2(\text{nom}) (F_C - 1)}{P_{pK}(\text{nom})}$$

$V_Z(\text{nom})$ = Nominal Zener Voltage

$P_{pK}(\text{nom})$ = Found from Figure 8 when device type and pulse width are known. For example, from Figure 8 a 1N6267 zener suppressor has a $P_{pK}(\text{nom})$ of 1.5 kW at a pulse width of 1 ms.

As seen from equation 2, zeners with a larger $P_{pK}(\text{nom})$ capability will have a lower $R_Z(\text{nom})$.

ZENER versus MOV TRADEOFFS

The clamping characteristics of Zeners and MOV's are best compared by measuring their voltages under transient conditions. Photos 1 through 9 are the result of an experiment that was done to compare the clamping characteristics of a Zener (Motorola 1N6281, approximately 1.5J capability) with those of an MOV (G.E. V27ZA4, 4J capability); both are 27 V devices.

Photo 1 shows the pulse generator output voltage. This generator synthesizes a transient pulse that is characteristic of those that may appear in the real world.

Photos 2 and 3 are clamping voltages of the MOV and Zener, respectively with a surge source impedance of $500\ \Omega$.

Photos 4 and 5 are the clamping voltages with a surge source impedance of $50\ \Omega$.

Photos 6 and 7 simulate a condition where the surge source impedance is $5\ \Omega$.

Photos 8 and 9 show a surge source impedance of $0.55\ \Omega$, which is at the limits of the Zener suppressor's capability.

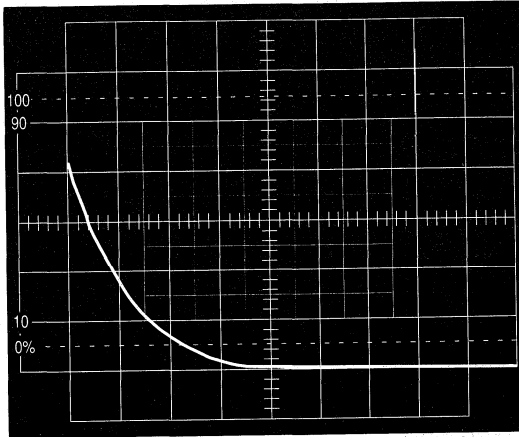

PHOTO 1

Open Circuit Transient Pulse

Vert: 20 V/div

Horiz: 0.5 ms/div

$V_{\text{peak}} = 90\ \text{V}$

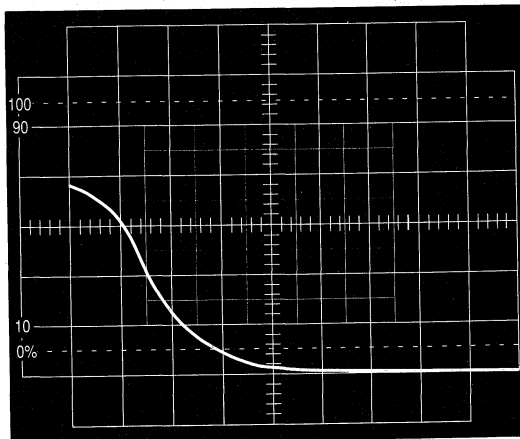

PHOTO 2

MOV (27 V)

Vert: 10 V/div

Horiz: 0.5 ms/div

Transient Source Impedance: $500\ \Omega$

$V_{\text{peak}} = 39.9\ \text{V}$

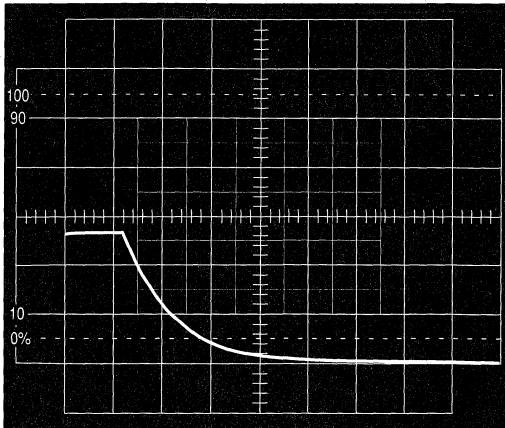

PHOTO 3
 Zener (27 V)
 Vert: 10 V/div
 Horiz: 0.5 ms/div
 Transient Source Impedance: 500 Ω
 $V_{\text{peak}} = 27 \text{ V}$

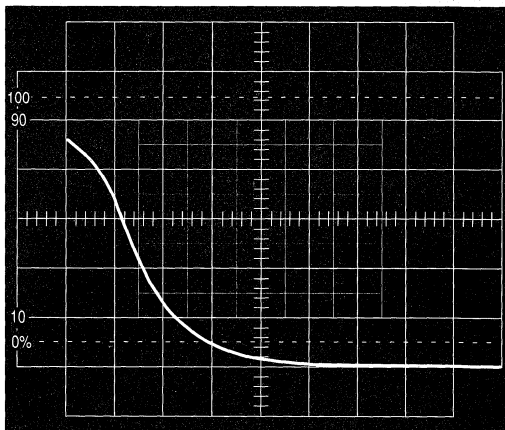

PHOTO 4
 MOV (27 V)
 Vert: 10 V/div
 Horiz: 0.5 ms/div
 Transient Source Impedance: 50 Ω
 $V_{\text{peak}} = 44.7 \text{ V}$

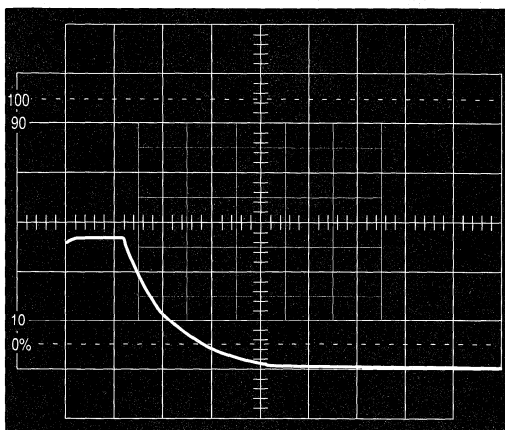

PHOTO 5
 Zener (27 V)
 Vert: 10 V/div
 Horiz: 0.5 ms/div
 Transient Source Impedance: 50 Ω
 $V_{\text{peak}} = 27 \text{ V}$

7

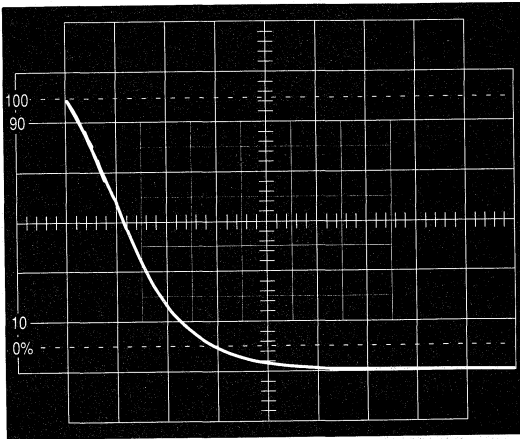

PHOTO 6

MOV (27 V)

Vert: 10 V/div

Horiz: 0.5 ms/div

Transient Source Impedance: 5 Ω

$V_{peak} = 52$ V

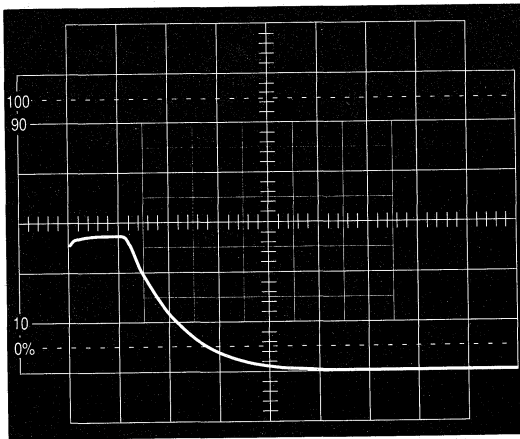

PHOTO 7

Zener (27 V)

Vert: 10 V/div

Horiz: 0.5 ms/div

Transient Source Impedance: 5 Ω

$V_{peak} = 28$ V

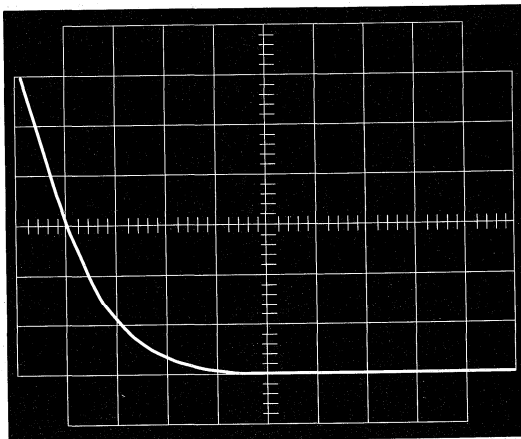

PHOTO 8

MOV (27 V)

Vert: 10 V/div

Horiz: 0.5 ms/div

Transient Source Impedance: 0.55 Ω

$V_{peak} = 62.5$ V

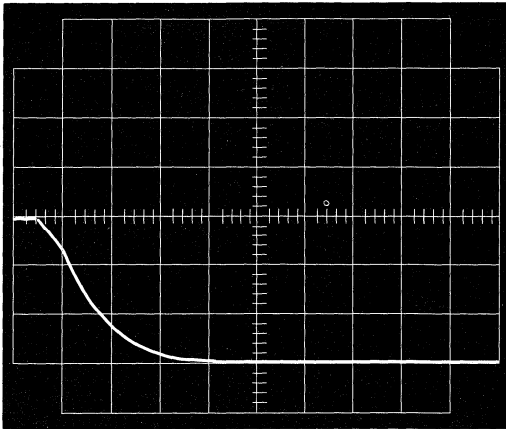

PHOTO 9

Zener (27 V)

Vert: 10 V/div

Horiz: 0.5 ms/div

Transient Source Impedance: 0.55 Ω

V_{peak} : 30.2 V

Peak Power: Approx 2000 W_{peak}
(The limit of this device's capability)

As can be seen by the photographs, the Zener suppressor has significantly better voltage clamping characteristics than the MOV even though that particular Zener has less than one-fourth the energy capability of the MOV it was compared with. However, the energy rating can be misleading because it is based on the clamp voltage times the surge current, and when using an MOV, the high impedance results in a fairly high clamp voltage. The major tradeoff with using a zener type suppressor is its cost versus power handling capability, but since it would take an "oversized" MOV to clamp voltages (suppress transients) as well as the zener, the MOV begins to lose its cost advantage.

If a transient should come along that exceeds the capabilities of the particular Zener, or MOV, suppressor that was chosen, the load will still be protected, since they both fail short.

The theoretical reaction time for Zeners is in the picosecond range, but this is slowed down somewhat with lead and package inductance. The 1N6267 Mosorb series of transient suppressors have a typical response time of less than one nanosecond. For very fast rising transients it is important to minimize external inductances (due to wiring, etc.) which will minimize overshoot.

Connecting Zeners in a back-to-back arrangement will enable bidirectional voltage clamping characteristics. (See Figure 10.)

If Zeners A and B are the same voltage, a transient of either polarity will be clamped at approximately that voltage since one Zener will be in reverse bias mode while the other will be in the forward bias mode. When clamping low voltage it may be necessary to consider the forward drop of the forward biased Zener.

The typical protection circuit is shown in Figure 11a. In almost every application, the transient suppression device is placed in parallel with the load, or component to be protected. Since the main purpose of the circuit is

to clamp the voltage appearing across the load, the suppressor should be placed as close to the load as possible to minimize overshoot due to wiring (or any inductive) effect. (See Figure 11b.)

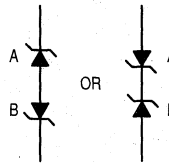

Figure 10. Zener Arrangement for Bidirectional Clamping

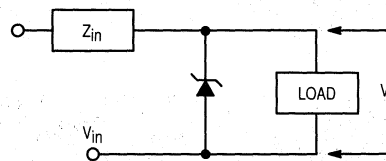

Figure 11a. Using Zener to Protect Load Against Transients

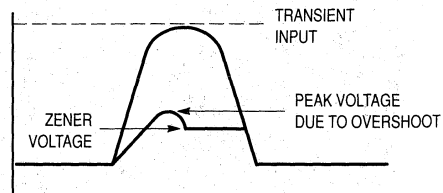

Figure 11b. Overshoot Due to Inductive Effect

Zener capacitance prior to breakdown is quite small (for example, the 1N6281 27 Volt Mosorb has a typical capacitance of 800 pF). Capacitance this small is desirable in the off-state since it will not attenuate wide-band signals.

When the Zener is in the breakdown mode of operation (e.g. when suppressing a transient) its effective capacitance increases drastically from what it was in the off-state. This makes the Zener ideal for parallel protection schemes since, during transient suppression, its large effective capacitance will tend to hold the voltage across the protected element constant; while in the off-state (normal conditions, no transient present), its low off-state capacitance will not attenuate high frequency signals.

Input impedance (Z_{in}) always exists due to wiring and transient source impedance, but Z_{in} should be increased as much as possible with an external resistor, if circuit constraints allow. This will minimize Zener stress.

CONCLUSION

The reliable use of semiconductor devices requires that the circuit designer consider the possibility of transient overvoltages destroying these transient-sensitive components.

These transients may be generated by normal circuit operations such as inductive switching circuits, energizing and deenergizing transformer primaries, etc. They do not present much of a problem since their energy content, duration and effect may easily be obtained and dealt with.

Random transients found on power lines, or lightning transients, present a greater threat to electronic components since there is no way to be sure when or how severe they will be. General guidelines were discussed to aid the circuit designer in deciding what size (capability and cost) suppressor to choose for a certain level of protection. There will always be a tradeoff between suppressor price and protection obtained.

Several different suppression devices were discussed with emphasis on Zeners and MOV's, since these are the most popular devices to use in most applications.

REFERENCES

- 1) GE Transient Voltage Suppression Manual, 2nd edition.
- 2) Motorola Zener Diode Manual.

SOME STRAIGHT TALK ABOUT Mosorbs™ TRANSIENT VOLTAGE SUPPRESSORS

INTRODUCTION

Distinction is sometimes made between devices trademarked Mosorb (by Motorola Inc.), and standard zener/avalanche diodes used for reference, low-level regulation and low-level protection purposes. It must be emphasized from the beginning that Mosorb devices are, in fact, zener diodes. The basic semiconductor technology and processing are identical. The primary difference is in the applications for which they are designed. Mosorb devices are intended specifically for transient protection purposes and are designed, therefore, with a large effective junction area that provides high pulse power capability while minimizing the total silicon use. Thus, Mosorb pulse power ratings begin at 500 watts — well in excess of low power conventional zener diodes which in many cases do not even include pulse power ratings among their specifications.

MOVs, like Mosorbs, do have the pulse power capabilities for transient suppression. They are metal oxide varistors (not semiconductors) that exhibit bidirectional avalanche characteristics, similar to those of back-to-back connected zeners. The main attributes of such devices are low manufacturing cost, the ability to absorb high energy surges (up to 600 joules) and symmetrical bidirectional “breakdown” characteristics. Major disadvantages are: high clamping factor, an internal wear-out mechanism and an absence of low-end voltage capability. These limitations restrict the use of MOVs primarily to the protection of insensitive electronic components against high energy transients in application above 20 volts, whereas, Mosorbs are best suited for precise protection of sensitive equipment even in the low voltage range — the same range covered by conventional zener diodes. The relative features of the two device types are covered in Table 1.

RELATIVE FEATURES OF MOVs and MOSORBS

Table 1.	
MOV	Mosorb/Zener Transient Suppressor
<ul style="list-style-type: none"> • High clamping factor. • Symmetrically bidirectional. • Energy capability per dollar usually higher than a silicon device. However, if good clamping is required the energy capability would have to be grossly overspecified resulting in higher cost. • Inherent wear out mechanism clamp voltage degrades after every pulse, even when pulsed below rated value. • Ideally suited for crude ac line protection. • High single-pulse current capability. • Degrades with overstress. • Good high voltage capability. • Limited low voltage capability. 	<ul style="list-style-type: none"> • Very good clamping close to the operating voltage. • Standard parts perform like standard zeners. Symmetrical bidirectional devices available for many voltages. • Good clamping characteristic could reduce overall system cost. • No inherent wear out mechanism. • Ideally suited for precise DC protection. • Medium multiple-pulse current capability. • Fails short with overstress. • Limited high voltage capability unless series devices are used. • Good low voltage capability.

IMPORTANT SPECIFICATIONS FOR MOSORB PROTECTIVE DEVICES

Typically, a Mosorb suppressor is used in parallel with the components or circuits being protected (Figure 1), in order to shunt the destructive energy spike, or surge, around the more sensitive components. It does this by avalancheing at its "breakdown" level, ideally representing an infinite impedance at voltages below its rated breakdown voltage, and essentially zero impedance at voltages above this level.

In the more practical case, there are three voltage specifications of significance, as shown in Figure 1a.

- a) V_{RWM} is the maximum reverse stand-off voltage at which the Mosorb is cut off and its impedance is at its highest value — that is, the current through the device is essentially the leakage current of a back-biased diode.
- b) $V_{(BR)}$ is the breakdown voltage — a voltage at which the device is entering the avalanche region, as indicated by a slight (specified) rise in current beyond the leakage current.
- c) V_{RSM} is the maximum reverse voltage (clamping voltage) which is defined and specified in conjunction with the maximum reverse surge current so as not to exceed the maximum peak power rating at a pulse width (t_p) of 1 ms (industry std time for measuring surge capability).

In practice, the Mosorb is selected so that its V_{RWM} is equal to or somewhat higher than the highest operating voltage required by the load (the circuits or components to be protected). Under normal conditions, the Mosorb is inoperative and dissipates very little power. When a transient occurs, the Mosorb converts to a very low dynamic impedance and the voltage across the Mosorb becomes the clamping voltage at some level above $V_{(BR)}$. The actual clamping level will depend on the surge current through the Mosorb. The maximum reverse surge current (I_{RSM}) is specified on the Mosorb data sheets at 1 ms and for a logarithmically decaying pulse waveform. The data sheet also contains curves to determine the maximum surge current rating at other time intervals.

Typically, Mosorb devices have a built-in safety margin at the maximum rated surge current because the clamp voltage, V_{RSM} , is itself, guardbanded. Thus, the parts will be operating below their maximum pulse-power (P_{pk}) rating even when operated at maximum reverse surge current).

If the transients are random in nature (and in many cases they are), determining the surge-current level can be a problem. The circuit designer must make a reason-

able estimate of the proper device to be used, based on his knowledge of the system and the possible transients to be encountered. (e.g., transient voltage, source impedance and time, or transient energy and time are some characteristics that must be estimated). Because of the very low dynamic impedance of Mosorb devices in the region between $V_{(BR)}$ and V_{RSM} , the maximum surge current is dependent on, and limited by the external circuitry.

In cases where this surge current is relatively low, a conventional zener diode could be used in place of a Mosorb or other dedicated protective device with some possible savings in cost. The surge capabilities most of Motorola's zener diode lines are discussed in Motorola's Application Note AN784.

In the data sheets of some protective devices, the parameter for response time is emphasized. Response time on these data sheets is defined as the time required for the voltage across the protective device to rise from 0 to $V_{(BR)}$, and relates primarily to the effective series impedance associated with the device. This effective impedance is somewhat complex and changes drastically from the blocking mode to the avalanche mode. In most applications (where the protective device shunts the load) this response time parameter becomes virtually meaningless as indicated by the waveforms in Figures 1b and 1c. If the response time as defined is very long, it still would not affect the performance of the surge suppressor.

However, if the series inductance becomes appreciable, it could result in "overshoot" as shown in Figure 1d that would be detrimental to circuit protection. In Mosorb devices, series inductance is negligible compared to the inductive effects of the external circuitry (primarily lead lengths). Hence, Mosorbs contribute little or nothing to overshoot and, in essence, the parameter of response time has very little significance. However, care must be exercised in the design of the external circuitry to minimize overshoot.

SUMMARY

In selecting a protective device, it is important to know as much as possible about the transient conditions to be encountered. The most important device parameters are reverse working voltage (V_{RWM}), surge current (I_{RSM}), and clamp voltage (V_{RSM}). the product of V_{RSM} and I_{RSM} yields the peak power dissipation, which is one of the prime categories for device selection.

The selector guide, in this book, gives a broad overview of the Mosorb transient suppressors now available from Motorola. For more detailed information, please contact your Motorola sales representative or distributor.

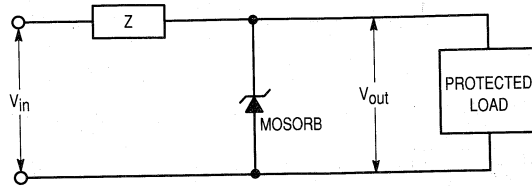

Figure 1.

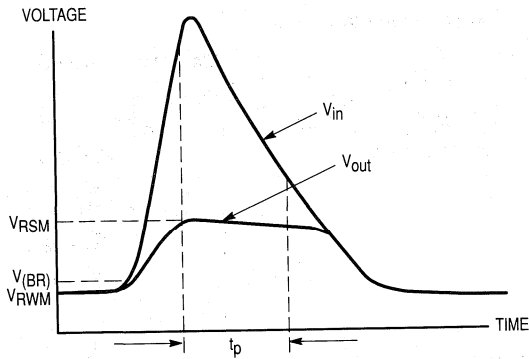

Figure 1a.

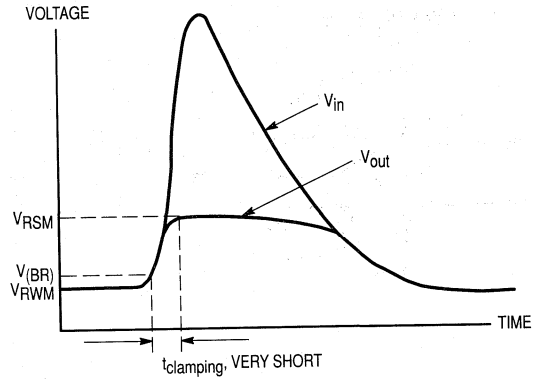

Figure 1b.

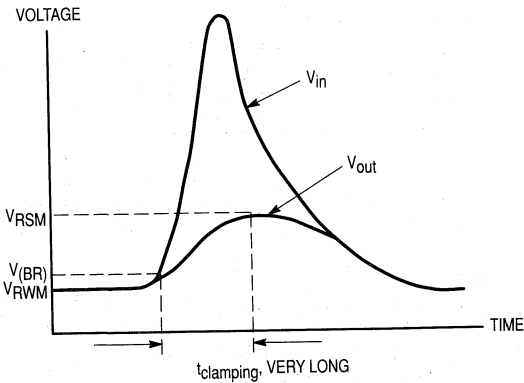

Figure 1c.

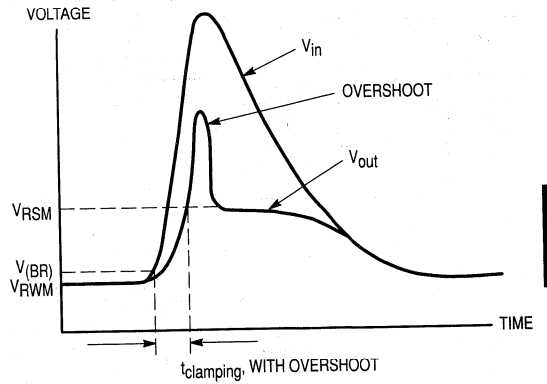
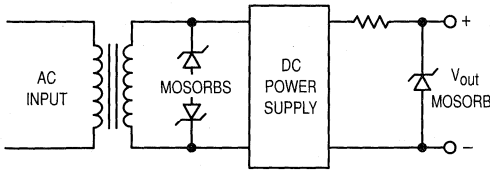

Figure 1d.

t_p = PULSE WIDTH OF INCOMING TRANSIENT

TYPICAL MOSORB APPLICATIONS

DC Power Supplies



Input/Output Regulator Protection

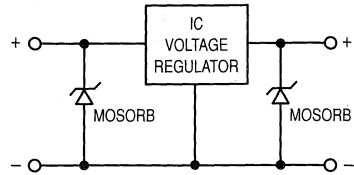

Inductive Switching Transistor Protection

Op Amp Protection

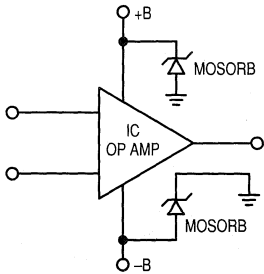

DC Motors — Reduces EMI

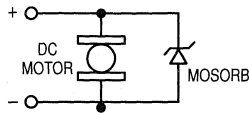

Memory Protection

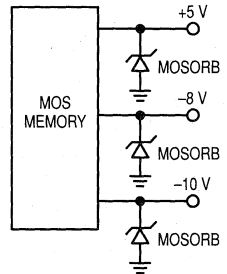

Microprocessor Protection

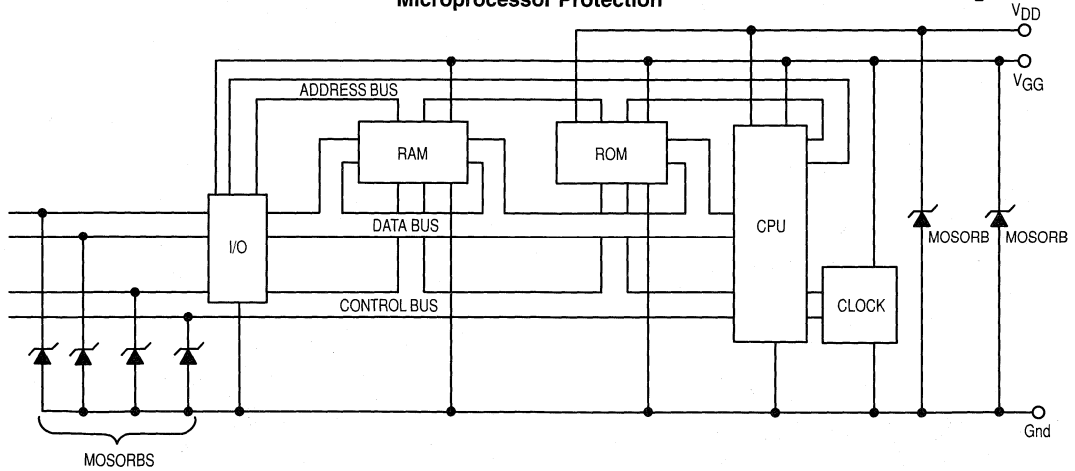

Computer Interface Protection

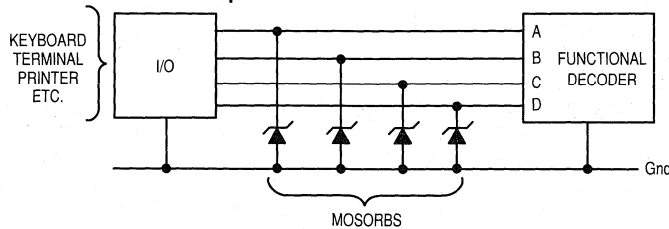

7

CHARACTERIZING OVERVOLTAGE TRANSIENT SUPPRESSORS

AR450

Prepared by
Al Pshaenich
Motorola Power Products Division

The use of overvoltage transient suppressors for protecting electronic equipment is prudent and economically justified. For relatively low cost, expensive circuits can be safely protected by one or even several of the transient suppressors on the market today. Dictated by the type and energy of the transient, these suppressors can take on several forms.

For example, in the telecommunication field, where lightning induced transients are a problem, such primary suppressors as gas tubes are often used followed by secondary, lower energy suppressors. In an industrial or automotive environment, where transients are systematically generated by inductive switching, the transient energy is more well-defined and thus adequately suppressed by relatively low energy suppressors. These lower energy suppressors can be zener diodes, rectifiers with defined reverse voltage ratings, metal oxide varistors (MOVs), thyristors, and trigger devices, among others. Each device has its own niche: some offer better clamping factors than others, some have tighter voltage tolerances, some are higher voltage devices, others can sustain more energy and still others, like the thyristor family, have low on-voltages. The designer's problem is selecting the best device for the application.

Thus, the intent of this article is twofold:

1. To describe the operation of the surge current test circuits used in characterizing lower energy transient suppressors.
2. To define the attributes of the various suppressors, allowing the circuit designer to make the cost/performance tradeoffs.

Surge suppressors are generally specified with exponentially decaying and/or rectangular current pulses. The exponential surge more nearly simulates actual surge current conditions — capacitor discharges, line and switching transients, lightning induced transients, etc., whereas rectangular surge currents are usually easier to implement and control.

To generate an exponential rating, a charged capacitor is simply dumped into the device under test (DUT) and the energy of each successive pulse increased until the device ultimately fails. The simplified circuit of Figure 1a describes the circuit. By varying the size of the capacitor C, the limiting resistor R2, and the voltage to which C is charged to, various peak currents and pulse widths (defined to the 10% discharge point in this paper) can be obtained. To automate this circuit, the series switches

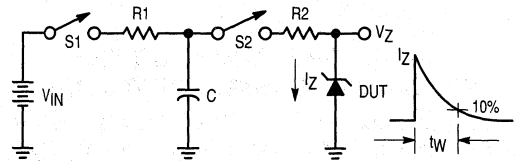

Figure 1a. Simplified Exponential Tester

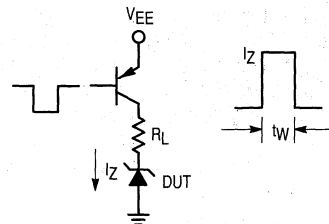

Figure 1b. Simplified Rectangular Tester Using PNP Switch

Figure 1. Basic Surge Current Testers

S1 and S2 can be replaced with appropriately controlled transistors or SCRs.

One method of easily implementing a rectangular surge current pulse is shown in the simplified schematic of Figure 1b. A PNP transistor switch connected to the positive supply V_{EE} applies power to the DUT. The current is obviously set by varying either V_{EE} and/or R_L . If however, the transistor switch were replaced with a variable, constant current source, measurement procedures are simplified as how the limiting resistor need not be selected for various current conditions.

As in most surge current evaluations, the DUT is ultimately subjected to destructive energy (current, voltage, pulse width), the failure points noted, and the derated points plotted to produce the energy limitation curve. Of particular interest is the junction temperature at which the DUTs are operated, be it near failure or at the specified derated point. This measurement relates to the overall reliability of the suppressor, i.e., can the suppressor sustain one surge current pulse or a thousand, and will it be degraded when operated above the specified maximum operating temperature?

The Rectangular Current Surge Suppressor Test Circuit to be described addresses these questions by implementing and measuring the rectangular current capability of the suppressor and determining the device junction temperature T_J shortly after the end of the surge current pulse. Knowing T_J , the energy to the DUT can be limited just short of failure and thus a complete surge curve generated with only one, or a few DUTs (Figure 6). Second, with the junction temperature known, a reliability factor can be determined for a practical application.

CIRCUIT OPERATION FOR THE RECTANGULAR CURRENT TESTER

The Surge Suppressor Test Circuit block diagram is shown in Figure 2 with the main blocks being the Constant Current Amplifier supplying I_Z to the DUT (a zener diode in this instance) during the power pulse and the Diode Forward Current Switch supplying I_F during the temperature sensing time. These two pulses are applied sequentially, first the much larger I_Z , and then the very small sense current I_F . During the I_F time, the forward voltage V_F of the diode is measured from which the junction temperature of the zener diode can be determined. This is simply done by calibrating the forward biased DUT with a specified low value of I_F in a temperature chamber, one point at 25°C and a second point at some elevated temperature. The result is the familiar diode forward voltage versus temperature linear plot with a slope of about $-2\text{ mV}/^\circ\text{C}$ for typical diodes (Figure 7a). Comparing the plot with the test circuit measured V_F yields the DUT junction temperature for that particular pulse width and I_Z (Figure 7b).

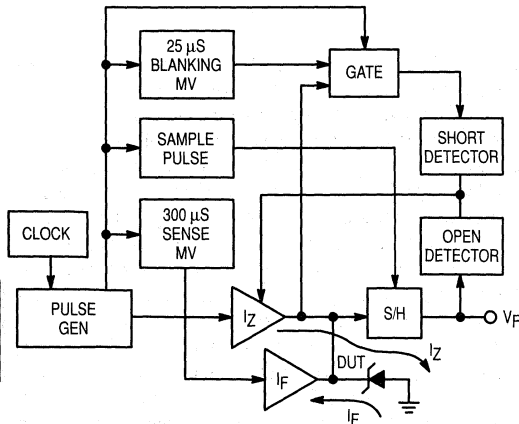

Figure 2. Surge Suppressor Test Circuit Block Diagram

The System Clock, Pulse Generator, the several monostable multivibrators ($25\ \mu\text{s}$ Blanking, Sample Pulse and $300\ \mu\text{s}$ Sense MVs) and Gate are fashioned from three CMOS gate ICs. The remaining blocks are the

Sample and Hold (S/H) circuit and two detectors for determining the status of failed DUTs, either shorted devices or open.

Shown in Figures 3 and 4 respectively, are the complete circuit and significant waveforms. Clocking for the system is derived from a CMOS, two inverters, astable MV (gates 1A and 1B) whose output triggers the two input NOR gate configured monostable MV (gates 1C and 1D) to produce the Pulse Generator output pulse (Figure 4b). Alternatively, a single pulse can be obtained by setting switch S2 to the One Shot position and depressing the pushbutton Start switch S1. Contact bounce is suppressed by the $100\ \text{ms}$ MV (gates 4C and D). Frequency of the astable MV, set by potentiometer R1, can vary from about $200\ \text{Hz}$ to $0.9\ \text{Hz}$ and the pulse width, controlled by R2 and the capacitor timing selector switch S3, from about $300\ \mu\text{s}$ to $1.3\ \text{s}$.

The positive going Pulse Generator output feeds the Constant Current Amplifier I_Z and turns on, in order, NPN transistor Q1, PNP transistor Q3, NPN Darlington Q4, PNP Power Darlington Q6 and parallel connected PNP Power Transistors Q8 and Q9. Transistor Q4 is configured as a constant current source whose current is set by the variable base voltage potentiometer R3. Thus, the voltage to the bases of Q6, Q8 and Q9 are also accordingly varied. Transistors Q8 and Q9 (MJ14003, I_C continuous of $60\ \text{A}$), also connected as constant current sources with their $0.1\ \Omega$ emitter ballasting resistors, consequently can produce a rectangular current pulse from a minimum of about $0.5\ \text{A}$ and still have adequate gain for $1\ \text{ms}$ pulses of $150\ \text{A}$ peak. Due to propagation delays of this amplifier, the I_Z current waveform is as shown in Figure 4f. Since Q8 and Q9 must be in the linear region for constant current operation, these transistors are power dissipation limited at high currents to the externally connected power supply V_+ of $60\ \text{V}$. Thus the maximum DUT voltage, taking into account the clamping factor of the device, should be limited to about $50\ \text{V}$. At wider pulse widths and consequently lower currents before the DUT fails, the V_+ supply should be proportionally reduced to minimize Q8, Q9 dissipation. As an example, a $28\ \text{V}$ surge suppressor operating at $100\ \text{ms}$ pulse widths can be tested to destructive limits with V_+ of about $40\ \text{V}$. Although a zener diode is shown as the DUT in the schematic, the test devices can be any rectifier with defined reverse voltage, e.g., surge suppressors.

Immediately after the power pulse is applied to the DUT, the negative going sense pulse from the $300\ \mu\text{s}$ MV (Gate 2A, Figure 4e) turns on series connected PNP transistor Q10 and NPN transistor Q11 of the Diode Forward Current Switch I_F . Sense current, set by current limiting resistor selector switch S4, thus flows up from ground through the forward biased DUT, the limiting resistor, and Q11 to the $-15\ \text{V}$ supply. The result, by monitoring the cathode of the DUT, is a $300\ \mu\text{s}$ wide, approximately $-0.6\ \text{V}$ pulse.

For accurate measurements of this pulse amplitude, sample and hold circuitry is employed. This consists of unity gain buffer amp U6, series FET switch Q13 and capacitor hold buffer amp U7. The sample pulse (Figure 4H) to the gate of the FET is delayed about 100 μ s (by monostable MV G-2C and G-2D) to allow for switching and thermal transients to settle down. This pulse is derived from the negative going, trailing edge output pulse of Gate 2D cutting off transistor Q18 for the RC time constant in its base circuit. The result is an approximate 8 μ s wide sample pulse. Consequently, the DC output voltage from hold amplifier U7 is a measure of the DUT junction temperature.

Invariably, most DUTs will fail short. When the surge suppressor tester is in the Free-run Mode, the power pulse subsequent to the DUT shorting could excessively stress the constant current drivers Q8 and Q9. To prevent this occurrence, the Short Detector circuit was implemented. This circuit consists of comparator U5A, 2 input NOR gate configured 25 μ s monostable MV (G1E and G1F), Gate Circuit G3A, 3B and 3C, and SCR Q16.

The 25 μ s MV (Figure 4D) is required to blank out turn-on switching transients to produce the waveform shown in Figure 4I. During the power pulse, U5A is normally high for a good DUT (Figure 4J). This waveform is NOR'd with gate 3B (inverted waveform of Figure 4I) to produce a low level (0 V) gate 3C output (Figure 4K).

If, however, the DUT is shorted, U5A output switches low resulting in a positive pulse output from G3C. This pulse triggers the SCR on, lighting the LED in its anode circuit and turning on the PNP transistor Q2 across the emitter-base of Q3, thus clamping off the I_Z power pulse. The circuit (Q16) can be reset by opening switch S5.

By and large, this Short Detector circuit was found adequate to protect transistors Q8 and Q9. However, for some wide pulse widths, relatively high current conditions, the propagation delay through the Short Detector was too great, resulting in excessive FBSOA (Forward Bias Safe Operating Area) stress on Q8 and Q9. Consequently, a faster Short Detector #2 was implemented.

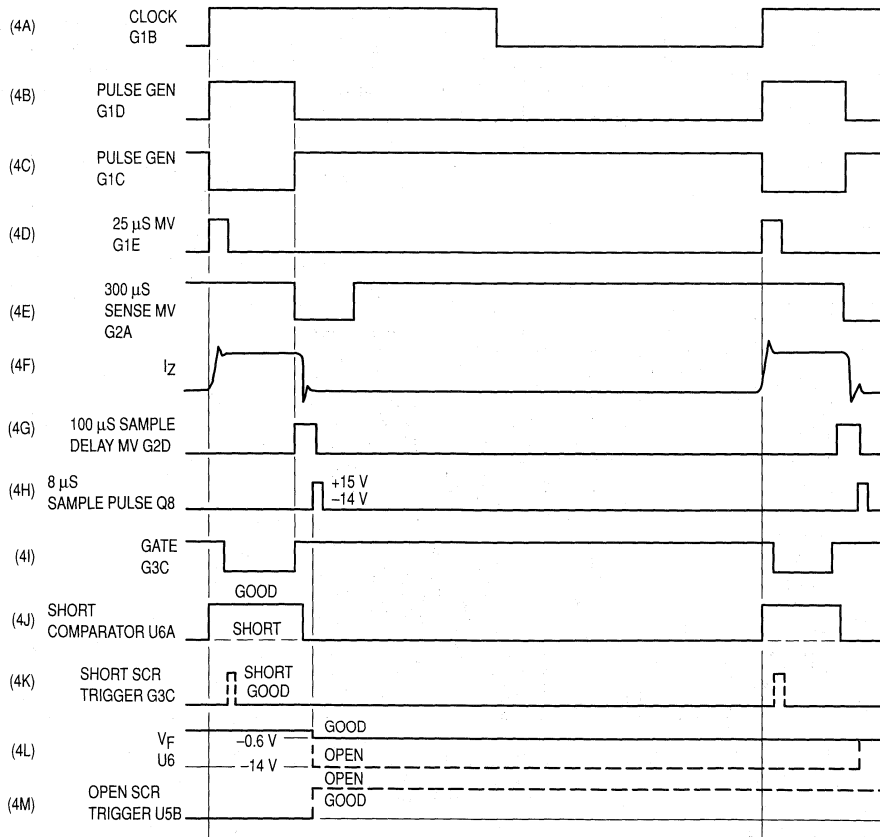

Figure 4. Surge Suppressor Test Circuit Waveforms

7

This circuit, connected to the collectors of Q8 and Q9, uses a differentiating network (R4, C1) to discriminate between the normally relatively slow fall time of the voltage pulse on the DUT, and the exceedingly fast fall time when the device fails. Thus, the R4-C1 time constant (5 ns) will only generate a negative going trigger to PNP transistor Q12 when the DUT voltage collapses during device failure. The positive going output from Q12 resets the flip-flop (gates 4A and 4B), which turns on the NPN transistor Q14. This transistor supplies drive to the two PNP clamp transistors (Q5 and Q7) placed respectively across the emitter-bases of the high, constant current stages Q6 and Q8 and Q9. Propagation delay is thus minimized, providing greater protection to the power stages of the tester. As an added safety feature, the positive going output from Gate 3C when Short Detector #1 is activated is also used to trigger the flip-flop.

On the few occasions when the DUT fails open, then the Open Detector consisting of comparator U5B and SCR Q17 comes into play. This circuit measures the DUT integrity during the sense time. For a good DUT ($V_F < -1$ V), U5B output remains low (see Figures 4L and 4M). However for an open DUT, V_F switches to the negative rail and U5B goes high, turning on Q17. As in the Short Detector, Q2 clamps off the IZ power amplifier.

All of the circuitry including the +15 V and -15 V regulated power supplies are self-contained, with the exception of the V_+ supply. For high current, narrow pulse width testing, this external supply should have 10 to 15 A capability. If not, additional energy storing capacitors across the supply output may be required.

CIRCUIT OPERATION FOR THE EXPONENTIAL SURGE CURRENT TESTER

To generate the surge current curve of peak current versus exponential discharge pulse width, the test circuit of Figure 5 was designed. This tester is an implementation of the simplified capacitor discharge circuit shown in Figure 1A, with the PNP high voltage transistor Q2 allowing the capacitor C to charge through limiting resistor R1 and a triggered SCR discharging the capacitor. As shown in Figure 5, the DUTs can be of any technology, although the device connected to the capacitor and discharge limiting resistor R_S is shown as an MOS SCR. It could just as well have been an SCR as the DUT or as the switch for the zener diode, rectifier, SIDAC, etc., DUTs.

System timing for this Exponential Surge Current Tester is derived from a CMOS quad 2 input NOR gate with gates 1A and 1B comprising a non-symmetrical astable MV of about 13 seconds on and about one second off (switch S3 open). The positive On pulse from gate 1B turns on the 500 V power MOSFET Q1 and the following PNP transistor Q2. The extremely high current gain FET allows for the large base current variation of Q2 with varying supply voltage (V_+). This capacitor charging

circuit has a 400 V blocking capability (limited by the V_{CEO} of Q2) and thus the capacitor C1 used should be comparably rated. When operating with high voltage ($V_+ = 200$ to 350 V) and large capacitors ($>3000 \mu\text{F}$), the power dissipated in the current limiting resistor R1 can be substantial, thus necessitating the illustrated 20 W rating. For longer charging times, switch S3 is closed, doubling the timing capacitor and the astable MV on time.

To discharge capacitor C1 and thereby generate the exponential surge current, the SCR must be fired. This trigger is generated by the positive going one second pulse from gate 1A being integrated by the R2C2 network, and then shaped by gates 1C and 1D. The net result of about 100 μs time delay from gate 1D ensures noncoincident timing conditions. This pulse output is then differentiated by C3-R3 with the positive going leading edge turning on Q3, Q4 and finally the SCR with about a 4 ms wide, 15 mA gate pulse. Consequently, the DUT is subjected to a surge current pulse whose magnitude is dictated by the voltage on the capacitor C1 and value of resistor R_S , and also whose pulse width to the 10% point is $2.3 R_S C1$. For a fixed pulse width, the DUT is then stressed with increasing charge (by increasing V_+) until failure occurs, usually a shorted device.

If the DUT is the SCR (or MOS SCR), the failed condition is obvious as the capacitor C1 will not be allowed to charge for subsequent timing cycles. However, when the DUT is the zener, rectifier, SIDAC or even an MOV, and the SCR is an adequately rated switch, the circuit will still discharge through the shorted DUT, but now the SCR alone will be stressed by the surge current. A shorted DUT can be detected by noting the voltage across the device during testing.

One problem encountered when stressing SCRs with high voltage is when the DUT fails short. The limiting resistor R1, which is only rated for 20 W, would now experience continuous power dissipation for the full On time — as much as 123 W ($[350 \text{ V}]^2/1\text{K}$). To prevent this occurrence, the P_{R1} Short Protection Circuit is incorporated. Since this is only a problem when high V_+ 's (>100 V) are used, the circuit can be switched in or out by means of switch S2. When activated, this circuit monitors the voltage on capacitor C1 some time after the charging cycle begins. If the capacitor is charging, normal operation occurs. However, if the SCR DUT is shorted, the absence of voltage on the capacitor is detected and the system is disabled.

The circuit consists of one CMOS IC with NAND gates 2A and 2B comprising a one second monostable time delay MV and gates 2C and 2D forming a comparator and NAND gate, respectively.

The negative going, trailing edge of gate 2A is differentiated by R4-C4, and amplified by Q5 to form a positive, 10 ms wide pulse (delayed by 1 sec) to gate 2D input. If the capacitor C1 is shorted, gate 2C output is high, allowing the now negative pulse from gate 2D to turn on PNP transistor Q6 and SCR Q7. This latches the

axial lead devices tested, were mounted between two spring loaded clips spaced 1 inch apart.

As shown in Figure 6 of the actual current failure points of the DUTs, at least four devices were tested at the various pulse widths, t_w (in this example from 0.5 ms to 100 ms).

Also shown in Figure 6 is the curve derived with a single DUT at an energy level just short of failure. This measurement was obtained by maintaining a constant rectifier forward voltage drop, V_F (0.25 V) for all pulse widths (junction temperature, T_J of 230°C) by varying the avalanche current. Thus, one device can be used, non-destructively, to generate the complete rectangular surge current curve.

It should also be pointed out that the definition for the exponential t_w in this article is the current discharge point to the 10% value of the peak test current I_{ZM} . Expressed in time constant τ , this would be 2.3 RC. Some data sheets describe t_w to the 50% point of I_{ZM} (0.69 τ) and others to 5 τ . To normalized these time scales (abscissa of curves) simply change the scales accordingly; i.e., $I_{ZM}/2$ pulse widths would be multiplied by 2.3/0.69 = 3.33 for t_w at 10% current pulses.

Figure 7a describes the actual temperature calibration curve (measured in a temperature chamber) of the MR2520L and Figure 7b, the junction temperature of the DUT at various 10 ms rectangular pulse current amplitudes. These temperatures are taken from the calibration curve (in actuality, an extremely linear curve), knowing the rectifier forward voltage drop immediately (within 100 μ s) after cessation of power. Note that the junction temperature just prior to device failure is about 290°C.

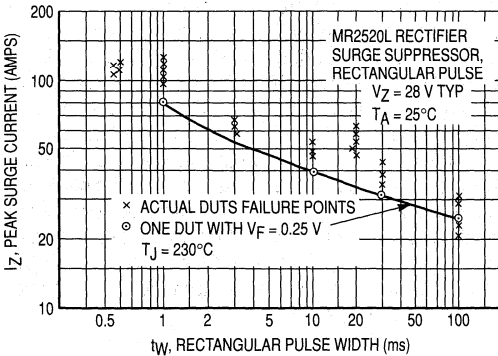

Figure 6. Experimental Rectangular Surge Current Capability Of The MR2520L Rectifier Surge Suppressor

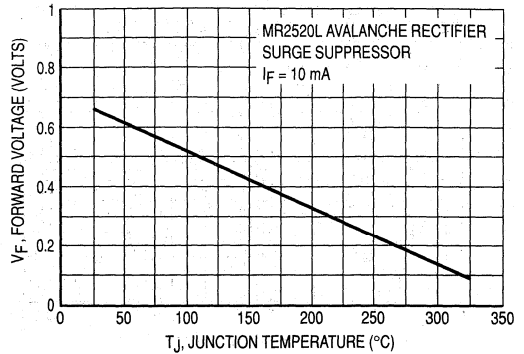

Figure 7a. Temperature Calibration Curve Of The MR2520L

RECTANGULAR PULSE $t_w = 10$ ms $I_F = 10$ mA	I_Z (A)	V_F (V)	T_J (°C)
	1	0.64	25
	10	0.57	75
	20	0.48	120
	30	0.36	180
	40	0.25	230
	50	0.15	290
	55	0.10	DUT FAILED

Figure 7b. Measured Forward Voltage

Figure 7. Calculated Junction Temperature Of The MR2520L Surge Suppressor At Various Avalanche Currents

ZENER OVERVOLTAGE TRANSIENT SUPPRESSOR

Illustrated in Figure 8 are the actual rectangular and exponential surge current curves of the P6KE30 overvoltage transient suppressor, an axial lead, Case 17, 30 V zener diode characterized and specified for surge currents. This device is specified for 600 W peak for a 1 ms exponential pulse measured at $I_{ZM}/2$. From the exponential curve, it is apparent that the device is very conservatively specified. Also, the relative magnitudes of the two curves reflect the differences in the rms values of the two respective pulses.

SIDAC

SIDACs are increasingly being used as overvoltage transient suppressors, particularly in telephone applications. Being a high voltage bilateral trigger device with relatively high current capabilities, they serve as a cost

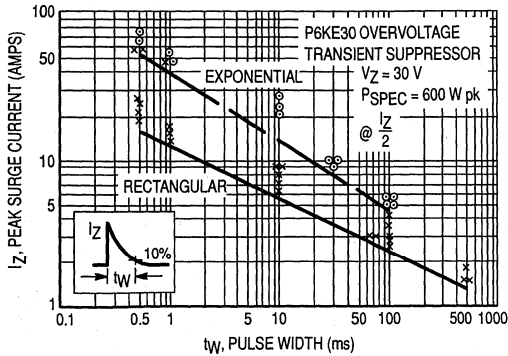

Figure 8. Surge Current Capability Of The P6KE30 Overvoltage Transient Suppressor As A Function Of Exponential & Rectangular Pulse Widths

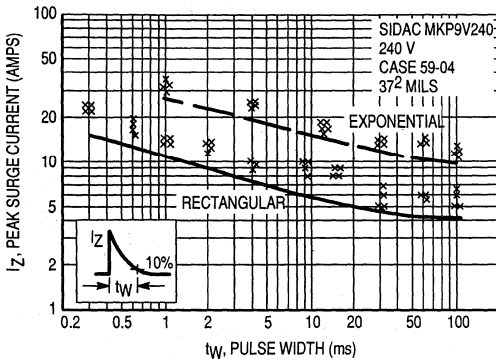

Figure 9. Measured Surge Current To Failure Of A SIDAC MKP9V240

effective overvoltage protection device. As in other trigger devices, when the SIDACs breakover voltage is exceeded, the device switches to a low voltage conduction state, allowing an inordinate amount of surge current to be passed. This is well illustrated by the surge current curves of Figure 9 which describe the small die size ($[37]^2$ mil) axial lead, Case 59-04, MKP9V240 SIDAC. The curves show that this 240 V device was able to handle, to failure, as much as 31 A and 15 A, respectively, for 1 ms exponential and rectangular current pulses. Under the same pulse conditions, the large die

($[78]^2$ mil) MK1V270 SIDAC handled 170 A and 60 A, respectively, as shown in Table 2.

OVERALL RATINGS

The compilation of all of the testing to date on the various transient suppressors is shown in Tables 1 and 2. Table 1 describes the zener suppressors, avalanche rectifiers and MOVs, comparing the die size and normalized costs (referenced to the MOV V39MA2A). From this data, the designer can make a cost/performance judgment.

Of interest is that the small pellet MOV is not the least expensive device. The P6KE30 overvoltage transient suppressor costs about 85% of the MOV, yet it can handle about three times the current (2.5 A to 0.7 A) for a 100 ms rectangular pulse. Under these conditions, the resultant clamping voltages for the zener and MOV were 32 V and 60 V respectively.

Also shown in the table is a 1.5 W zener diode specified for zener applications. This low surge current device costs three times the MOV, illustrating that tight tolerance zener diodes are not cost effective and that the user should use devices designed and priced specifically for the suppressor application.

Thyristor type surge suppressors are shown in Table 2. They include four SIDAC series, two SCRs designed and characterized specifically for crowbar applications and also the MOS SCR MCR1000. The MOS SCR, a process variation of the vertical structure power MOSFET, combines the input characteristics of the FET with the latching action of an SCR.

All devices were surge current tested with the resultant peak currents being impressively high. The TO-220 ($[150]^2$ mil SCR MCR69 for example, reached peak current levels approaching 700 A for a 1 ms exponential pulse. The guaranteed, derated, time base translated curves for the crowbar SCR family of devices are shown in Figure 10, as is the MK1V SIDAC in Figure 11.

Figures 12A-C describe the guaranteed, reverse surge design limits for the avalanche rectifier devices. These three figures illustrate, respectively, the peak current, power and energy capabilities of these overvoltage transient suppressors derived from exponential testing. The peak power, P_{pk} , ordinate of the curve is simply the product of the derated I_Z and V_Z and the energy curve, the product of P_{pk} and t_W .

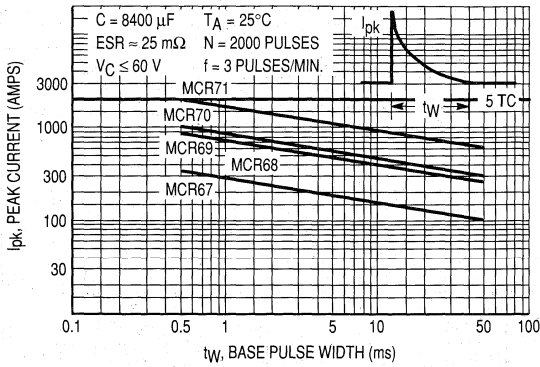

a. Peak Surge Current versus Pulse Width

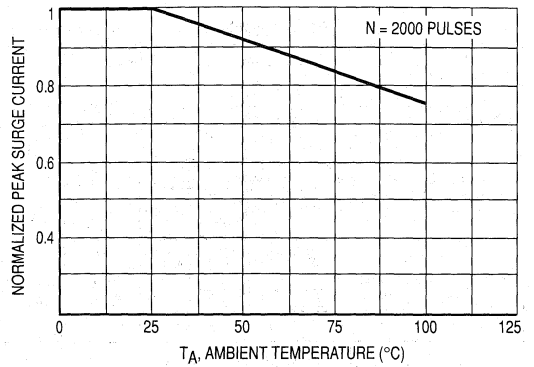

b. Peak Surge Current versus Ambient Temperature

Figure 10. SCR Crowbar Derating Curves

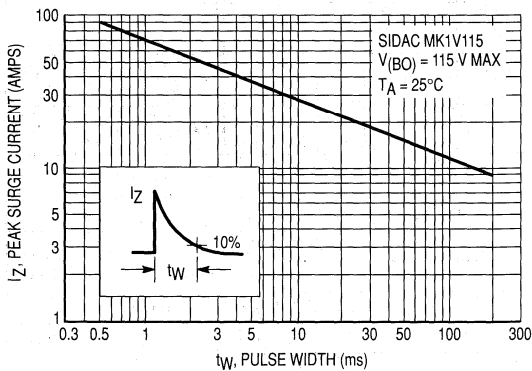

Figure 11. Exponential Surge Current Capability Of The MK1V SIDAC, Pulse Width versus Peak Current

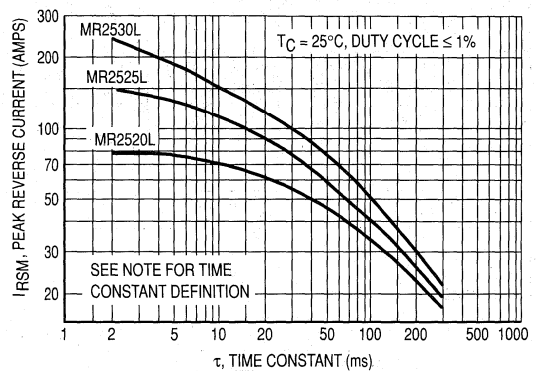

Figure 12A. Peak Current

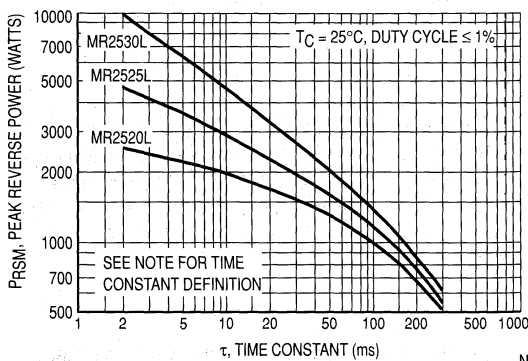

Figure 12B. Peak Power

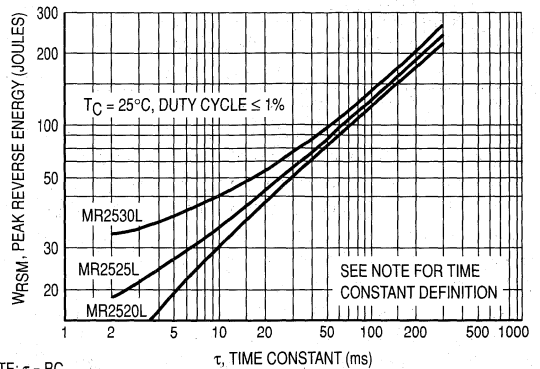

Figure 12C. Energy

Figure 12. Guaranteed Reverse Surge Design Limits for the MR2525L & MR2530L Overload Transient Suppressors

NOTE: $\tau = RC$

Table 1. Measured Surge Current Capability of Transient Suppressors

Device Type	Title	Part No.	Case	Spec.		Die Size	Peak Current at Pulse Widths, I_{pk} (Amps)								Clamping Factor $\frac{V_{1ms}}{V_{100ms}}$	Norm. Cost *	
				Volt	Power (Energy)		1 ms		10 ms		20 ms		100 ms				
							Exp.	Rect.	Exp.	Rect.	Exp.	Rect.	Exp.	Rect.			
Avalanche Rectifier	Surge Supp., Overvoltage Transient Suppressor	MR2520L	194-05	24-32 V	2.5 KW Peak	150 ² mil		85 A		40		30		18	$\frac{27}{22} = 1.2$	4.0	
		MR2525L		24-32 V	10 KW Peak	196 ² mil		150 A		70		54		37	$\frac{31}{23} = 1.3$		
Zener	1.5 W Zener Diode	1N5936A	DO-41	30 V	1.5 W Cont.	37 ² mil	12 A	5	6	2.5	5	2	3	1.3	$\frac{41}{30} = 1.4$	3.2	
		1N5932A		20 V			23 A	6	10	2.8	7	2.3	5	1.4	$\frac{28}{23} = 1.2$		
	Overvoltage Transient Suppressor	P6KE30	17	30 V	600 W Peak	60 ² mil	43 A	14	14	5	10	4.5	5	2.5	$\frac{41}{32} = 1.3$	0.85	
		P6KE10		10 V				24 A		12		9		5.5	$\frac{16}{13} = 1.2$		
	MOSORB	1.5KE30	41A-02	30 V	1500 W Peak	104 ² mil								4	$\frac{35}{33} = 1.1$	1.8	
				24 V				35 A		10					6		$\frac{30}{28} = 1.1$
MOV**	Metal Oxide Varistor	V39MA2A	Axial Lead	28 V	(0.16 Joules)	3 mm		9 A		5				0.7	$\frac{80}{60} = 1.33$	6 A 0.7 A	1.0
		V33ZA1	Radial Lead	26 V	(1.0 Joules)	7 mm				35				4 A	$\frac{105}{80} = 1.31$	35 A 4 A	

**G.E.

Table 2. Measured Surge Current Of Thyristor Type Devices

Technology	Device	Voltage Ratings	Case	Die Size	$I_{pk} @ t_w$				Norm Cost *
					1 ms		10 ms		
					Exponent.	Rectang.	Exponent.	Rectang.	
SIDAC	MKP9V130 Series	104 V-135 V	59-04	37 ² mil	40 A	13 A	16 A	8 A	0.87
	MKP9V240 Series	220 V-280 V			31 A	15 A	20 A	8 A	
	MK1V135 Series	120 V-135 V	267-01	78 ² mil	140 A	80 A	55 A	30 A	1.1
	MK1V270 Series	220 V-280 V			170 A	60 A	90 A	28 A	
SCR	MCR68 Series	25 V-400 V	TO-220	92 ² mil	300 A		170 A		1.2
	MCR69 Series			150 ² mil	700 A		400 A		1.9
MOS SCR	MCR1000 Series	200 V-600 V		127 mil x 183 mil	250 A		170 A		9.3

*Normalized to G.E. MOV V39MA2A, Qty 1-99, 1984 Price

7 Additionally, the published non-repetitive peak power ratings of the various zener diode packages are illustrated in Figure 13. Figure 14 describes the typical derating factor for repetitive conditions of duty cycles up to 20%. Using these two empirically derived curves, the designer can then determine the proper zener for the repetitive peak current conditions.

At first glance the derating of curves of Figure 14 appear to be in error as the 10 ms pulse has a higher derating factor than the 10 μs pulse. However, when the mathematics of multiplying the derating factor of Figure 14 by the peak power value of Figure 13 is performed, the resultant respective power and current capability of the device follows the expected trend. For example, for a 5 W, 20 V zener operating at a 1.0% duty cycle, the

respective derating factors for 10 μs and 10 ms pulses are 0.08 and 0.47. The non-repetitive peak power capabilities for these two pulses (10 μs and 10 ms) are about 1300 W and 50 W respectively, resulting in repetitive power and current capabilities of about 104 W and 24 W and consequently 5.2 A and 1.2 A.

MOV

All of the surge suppressors tested with the exception of the MOV are semiconductors. The MOV is fabricated from a ceramic (ZnO), non-linear resistor. This device has wide acceptance for a number of reasons, but for many applications, particularly those requiring good clamping factors, the MOV is found lacking; (clamping

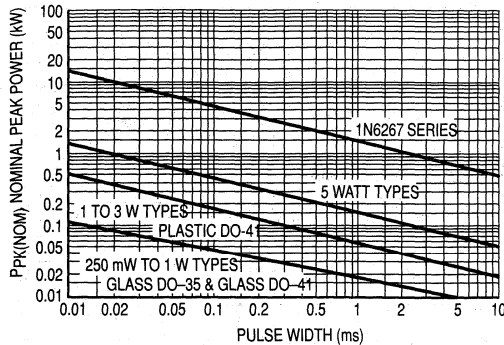

Figure 13. Peak Power Ratings of Zener Diodes

Power is defined as $V_Z(NOM) \times I_Z(PK)$ where $V_Z(NOM)$ is the nominal zener voltage measured at the low test current used for voltage classification.

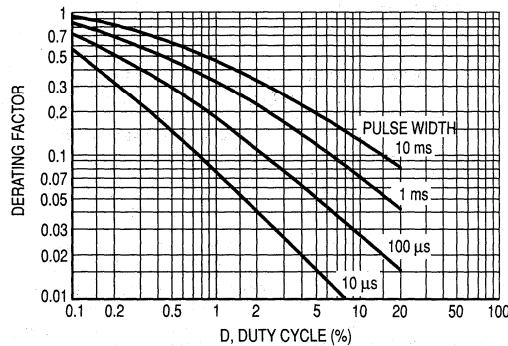
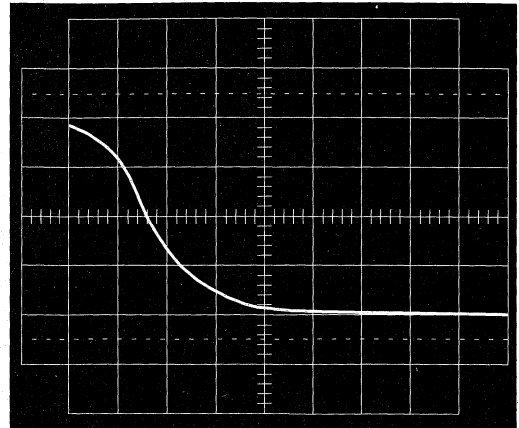

Figure 14. Typical Derating Factor for Duty Cycle

factor is defined as the ratio of V_Z at the test current to that at 1.0 mA). This is photographically illustrated in Figure 15 which compares a 27 V zener (1N6281) with a 27 V MOV (V27ZA4). The input waveform, through a source impedance resistance to the DUTs, was an exponentially decaying voltage waveform of 90 V peak. Figures 15A and B compare the output waveforms (across the DUTs) when the source impedance was 500 Ω and Figures 15C and D for a 50 Ω condition. The zener clamped at about 27 V for both impedances whereas the MOV was about 40 V and 45 V respectively.

Surge current capabilities of a comparably powered MOV were also determined, as shown in the curve of Figure 16. Although the MOV, a V39MA2A, is specified

SOURCE IMPEDANCE $R_S = 500 \Omega$



27 V MOV
G.E. V27ZA4, 4 JOULES CAPABILITY

Figure 15A

SOURCE IMPEDANCE $R_S = 500 \Omega$

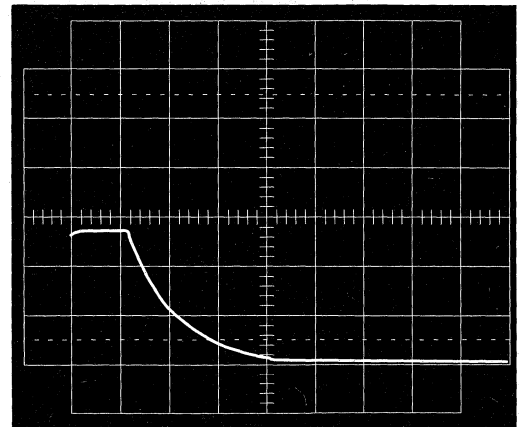

27 V ZENER DIODE
MOTOROLA 1N6281, APPROX. 1.5 JOULES

Figure 15B

as a 28 V continuous device ($39 V \pm 10\%$ at 1 mA) at the pulse widths and currents tested, the resultant voltage V_Z across the MOV — 80 V at about 6 A — necessitated a high voltage fixture. This was accomplished with a circuit similar to that of Figure 1B.

SOURCE IMPEDANCE $R_S = 50 \Omega$

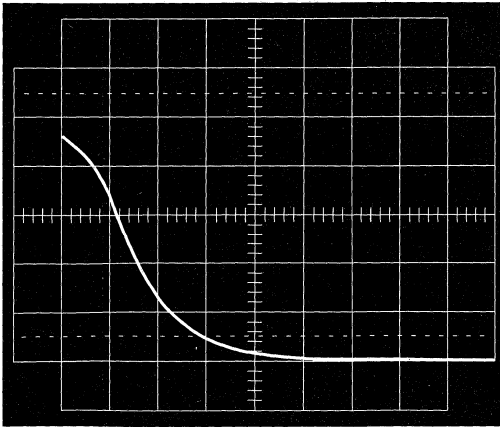

27 V MOV

Figure 15C

SOURCE IMPEDANCE $R_S = 50 \Omega$

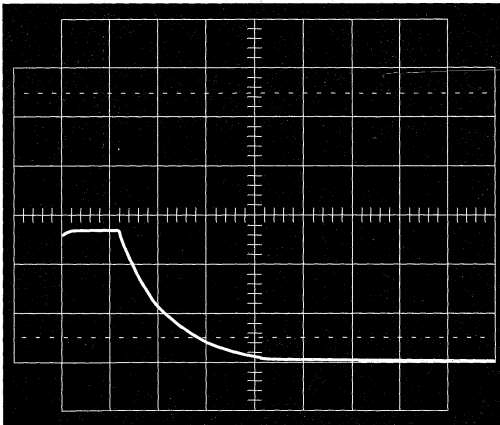

27 V ZENER DIODE

Figure 15D

Figure 15. Clamping Characteristics of a 27 V Zener Diode and 27 V MOV

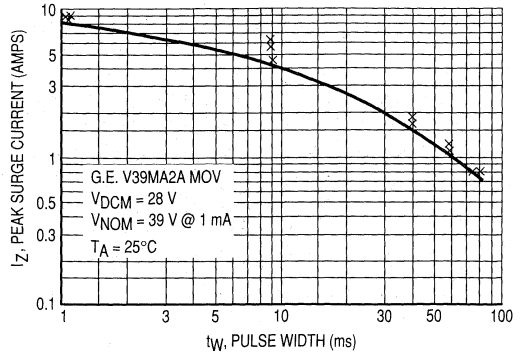

Figure 16. Rectangular Surge Current Capability Of The V39MA2A MOV

But MOVs do have their own niche in the marketplace, as described in Table 3, the Relative Features of MOVs and MOSORBs.

Table 3. Relative Features of MOVs and MOSORBs

MOV	MOSORB/Zener Transient Suppressor
High Clamping Factor	Very good clamping close to the operating voltage.
Symmetrically bidirectional	Standard parts perform like standard zeners. Symmetrical bidirectional devices available for many voltages.
Energy capability per dollar usually much greater than a silicon device. However, if good clamping is required a higher energy device would be needed, resulting in higher cost.	Good clamping characteristics could reduce overall cost.
Inherent wear out mechanism, clamp voltage degrades after every pulse, even when pulsed below rated value.	No inherent wear out mechanism.
Ideally suited for crude AC line protection.	Ideally suited for precise DC protection.
High single-pulse current capability.	Medium multiple-pulse current capability.
Degrades with overstress.	Fails short with overstress.
Good high voltage capability.	Limited high voltage capability unless series devices are used.
Limited low voltage capability.	Good low voltage capability.

SUMMARY

The surge current capabilities of low energy overvoltage transient suppressors have been demonstrated, including cost/performance comparison of rectifiers, zeners, thyristor type suppressors, and MOVs. Both rectangular and exponential testing have been performed with the described testers. Additionally, the Rectangular Current Surge Tester has the capability of measuring the diode junction temperature of zeners and rectifiers at various power levels, thus establishing safe operating limits.

REFERENCES

1. Cherniak, S., *A Review of Transients and Their Means of Suppression*, Motorola Application Note AN843.
2. Wilhardt, J., *Transient Power Capability of Zener Diodes*, Motorola Application Note AN784.
3. Pshanenich, A., *Characterizing the SCR for Crowbar Applications*, Motorola Application Note AN879.
4. Pshaenich, A., *The SIDAC, A New High Voltage Trigger that Replaces Circuit Complexity and Cost*, Motorola Engineering Bulletin EB-106.
5. General Electric, *Transient Voltage Suppression Manual*, Second Edition.

MEASUREMENT OF ZENER VOLTAGE TO THERMAL EQUILIBRIUM WITH PULSED TEST CURRENT

Prepared by
Herb Saladin
Discrete Power Application Engineering

This paper discusses the zener voltage correlation problem which sometimes exists between the manufacturer and the customer's incoming inspection. A method is shown to aid in the correlation of zener voltage between thermal equilibrium and pulse testing. A unique double pulsed sample and hold test circuit is presented which improves the accuracy of correlation.¹

Several zener voltages versus zener pulsed test current curves are shown for four package styles. An appendix is attached for incoming inspection groups giving detailed information on tolerances involved in correlation.

INTRODUCTION

For many years the major difficulty with zener diode testing seemed to be correlation of tight tolerance voltage specifications where accuracy between different test setups was the main problem. The industry standard and the EIA Registration system adopted thermal equilibrium testing of zener diodes as the basic test condition unless otherwise specified. Thermal equilibrium was chosen because it was the most common condition in the final circuit design and it was the condition that the design engineers needed for their circuit design and device selection. Thermal equilibrium testing was also fairly simple to set-up for sample testing at incoming inspection of standard tolerance zeners.

In recent years with the advent of economical computerized test systems many incoming inspection areas have implemented computer testing of zener diodes which has been generating a new wave of correlation problems between customers and suppliers of zener diodes.

The computerized test system uses short duration pulse test techniques for testing zener diodes which does not directly match the industry standard thermal equilibrium test specifications.

This paper was prepared in an attempt to clarify the differences between thermal equilibrium and short duration pulse testing of zener diodes, to provide a test circuit that allows evaluation at various pulse widths and a suggested procedure for incoming inspection areas that will allow meaningful correlation between thermal equilibrium and pulse testing.

In the measurement of zener voltage (V_Z), the temperature coefficient effect combined with test current heating can present a problem if one is attempting to correlate V_Z measurements made by another party (Final Test, Quality Assurance or Incoming Inspection).² This paper is intended as an aid in determining V_Z at some test current (I_{ZT}) pulse width other than the pulse width used by the manufacturer.

Thermal equilibrium (TE) is reached when diode junction temperature has stabilized and no further change will occur in V_Z if the I_{ZT} time is increased.² This absolute value can vary depending on the mounting method and amount of heatsinking. Therefore, thermal equilibrium conditions have to be defined before meaningful correlation can exist.

Normalized V_Z curves are shown for four package styles and for three to five voltage ratings per package. Pulse widths from 1 ms up to 100 seconds were used to arrive at or near thermal equilibrium for all packages with a given method of mounting.

Mounting

There are five conditions that can affect the correlation of V_Z measurements and are: 1) instrumentation, 2) T_A , 3) I_{ZT} time, 4) PD and 5) mounting. The importance of the first four conditions is obvious but the last one, mounting, can make the difference between good and poor correlation. The mounting can have a very important part in V_Z correlation as it controls the amount of heat and rate of heat removal from the diode by the mass and material in contact with the diode package.

Two glass axial lead packages (DO-35 and DO-41), curves (Figures 5 and 6) were measured with standard Grayhill clips and a modified version of the Grayhill clips to permit lead length adjustment.

Test Circuit

The test circuit (Figure 8) consists of standard CMOS logic for pulse generation, inverting and delaying. The logic drives three bipolar transistors for generation of the power pulse for I_{ZT} . V_Z is fed into a unique sample and hold (S/H) circuit consisting of two high input impedance operational amplifiers and a field effect transistor switch.

For greater accuracy in V_Z measurements using a single pulse test current, the FET switch is double pulsed. Double pulsing the FET switch for charging the

S/H capacitor increases accuracy of the charge on the capacitor as the second pulse permits charging the capacitor closer to the final value of V_Z .

The timing required for the two pulse system is shown in waveform G-3C whereby the initial sample pulse is delayed from time zero by a fixed 100 μ s to allow settling time and the second pulse is variable in time to measure the analog input at that particular point. The power pulse (waveform G-2D) must also encompass the second sample pulse.

To generate these waveforms, four time delay monostable multivibrators (MV) are required. Also, an astable MV, is required for free-running operation; single pulsing is simply initiated by a push-button switch S1. All of the pulse generators are fashioned from two input, CMOS NOR gates; thus three quad gate packages (MC14001) are required. Gates 1A and 1B form a classical CMOS astable MV clock and the other gates (with the exception of Gate 2D) comprise the two input NOR gate configured monostable MV's. The Pulse Width variable delay output (Gate 1D) positions the second sample pulse and also triggers the 100 μ s Delay MV and the 200 μ s Extended Power Pulse MV. The respective positive going outputs from gates 3A and 2C are diode NOR'ed to trigger the Sample Gate MV whose output will consequently be the two sample pulses. These pulses then turn on the PNP transistor Q1 level translator and the following S/H N-channel FET series switch Q2. Op amps U4 and U5, configured as voltage followers, respectively provide the buffered low output impedance drive for the input and output of the S/H. Finally, the pulse extended Power Gate is derived by NORing (Gate 2D) the Pulse Width Output (Gate 1D) with the 200 μ s MV output (Gate 2C). This negative aging gate then drives the Power Amplifier, which, in turn, powers the D.U.T. The power amplifier configuration consists of cascaded transistors Q3-Q5, scaled for test currents up to 2 A.

Push button switch (S4) is used to discharge the S/H capacitor. To adjust the zero control potentiometer, ground the non-inverting input (Pin 3) of U4 and discharge the S/H capacitor.

Testing

The voltage V_{CC} , should be about 50 volts higher than the D.U.T. and with R_C selected to limit the I_{ZT} pulse to a value making $V_{ZT} I_{ZT} = 1/4 P_D$ (max), thus insuring a good current source. All testing was performed at a normal room temperature of 25°C. A single pulse (manual) was used and at a low enough rate that very little heat remained from the previous pulse.

The pulse width MV (1C and 1D) controls the width of the test pulse with a selector switch S3 (see Table 1 for capacitor values). Fixed widths in steps of 1, 3 and 5 from 1 ms to 10 seconds in either a repetitive mode or single pulse is available. For pulse widths greater than 10 seconds, a stop watch was used with push button switch (S1) and with the mode switch (S2) in the > 10 seconds position.

For all diodes with V_Z greater than about 6 volts a resistor voltage divider is used to maintain an input of about 6 V to the first op amp (U4) so as not to overload or saturate this device. The divider consists of R5 and R6 with R6 being 10 k Ω and R5 is selected for about a 6 V input to U4. Precision resistors or accurate known values are required for accurate voltage readout.

Switch Position	*C(μ F)	t(ms)
1	0.001	1
2	0.004	3
3	0.006	5
4	0.01	10
5	0.04	30
6	0.06	50
7	0.1	100
8	0.4	300
9	0.6	500
10	1.0	1K
11	1.2	3K
12	6.0	5K
13	10	10K

*Approximate Values

Using Curves

Normalized V_Z versus I_{ZT} pulse width curves are shown in Figure 1 through 6. The type of heatsink used is shown or specified for each device package type. Obviously, it is beyond the scope of this paper to show curves for every voltage rating available for each package type. The object was to have a representative showing of voltages including when available, one diode with a negative temperature coefficient (TC).

These curves are actually a plot of thermal response versus time at one quarter of the rated power dissipation. With a given heatsink mounting, V_Z can be calculated at some pulse width other than the pulse width used to specify V_Z .

For example, refer to Figure 5 which shows normalized V_Z curves for the axial lead DO-35 glass package. Three mounting methods are shown to show how the mounting effects device heating and thus V_Z . Curves are shown for a 3.9 V diode (1N5228B) which has a negative TC and a 12 V diode (1N5242B) having a positive TC.

In Figure 5, the two curves generated using the Grayhill mountings are normalized to V_Z at TE using the Motorola fixture. There is very little difference in V_Z at pulse widths up to about 10 seconds and mounting only causes a very small error in V_Z . The maximum error occurs at TE between mountings and can be excessive if V_Z is specified at TE and a customer measures V_Z at some narrow pulse width and does not use a correction factor.

Using the curves of Figure 5, V_Z can be calculated at any pulse width based upon the value of V_Z at TE which is represented by 1 on the normalized V_Z scale. If the

1N5242B diode is specified at $12\text{ V} \pm 1.0\%$ at 90 seconds which is at TE, V_Z at 100 ms using either of the Grayhill clips curves would be 0.984 of the V_Z value at TE or 1 using the Motorola fixture curve. If the negative TC diode is specified at $3.9\text{ V} \pm 1.0\%$ at TE (90 seconds), V_Z at 100 ms would be 1.011 of V_Z at TE (using Motorola fixture curve) when using the Grayhill Clips curves.

In using the curves of Figure 5 and 6, it should be kept in mind that V_Z can be different at TE for the three mountings because diode junction temperature can be different for each mounting at TE which is represented by 1 on the V_Z normalized scale. Therefore, when the correlation of V_Z between parties is attempted, they must use the same type of mounting or know what the delta V_Z is between the two mountings involved.

The Grayhill clips curves in Figure 6 are normalized to the Motorola fixture at TE as in Figure 5. Figures 1 through 4 are normalized to V_Z at TE for each diode and would be used as Figures 5 and 6.

Measurement accuracy can be affected by test equipment, power dissipation of the D.U.T., ambient temperature and accuracy of the voltage divider if used on the input of the first op-amp (U4). The curves of Figures 1 through 6 are for an ambient temperature of 25°C , at other ambients, θV_Z has to be considered and is shown on the data sheet for the 1N5221B series of diodes. θV_Z

is expressed in $\text{mV}/^\circ\text{C}$ and for the 1N5228B diode is about $-2\text{ mV}/^\circ\text{C}$ and for the 1N5242B, about $1.6\text{ mV}/^\circ\text{C}$. These values are multiplied by the difference in T_A from the 25°C value and either subtracted or added to the calculated V_Z depending upon whether the diode has a negative or positive TC.

General Discussion

The TC of zener diodes can be either negative or positive, depending upon die processing. Generally, devices with a breakdown voltage greater than about 5 V have a positive TC and diodes under about 5 V have a negative TC.

Conclusion

Curves showing V_Z versus $I_Z T$ pulse width can be used to calculate V_Z at a pulse width other than the one used to specify V_Z . A test circuit and method is presented to obtain V_Z with a single pulse of test current to generate V_Z curves of interest.

References

- (1) Al Pshaenich, "Double Pulsing S/H Increases System Accuracy"; Electronics, June 16, 1983.
- (2) Motorola Zener Diode Manual, Series A, 1980.

FIGURES 1 thru 8 — Conditions: Single Pulse, $T_A = 25^\circ\text{C}$, $V_Z | Z_T = 1/4 P_D$ (Max) Each device normalized to V_Z at TE.

AXIAL LEAD PACKAGES: MOUNTING STANDARD GRAYHILL CLIPS

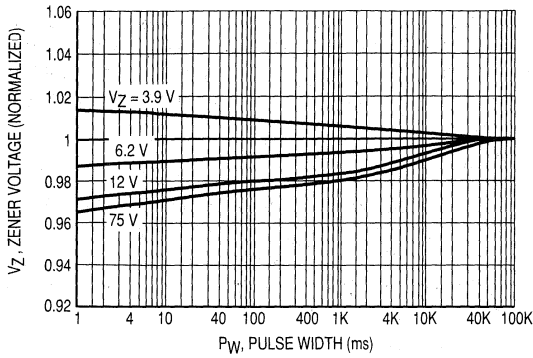

Figure 1. DO-35 (Glass) 500 mW Device

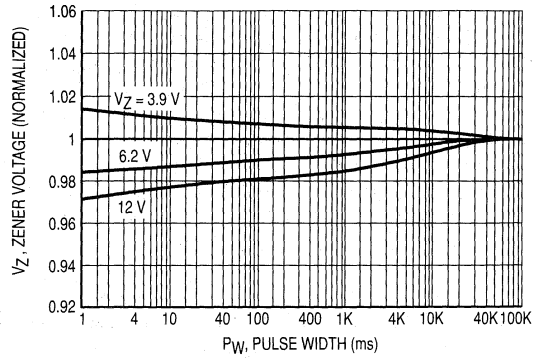

Figure 2. DO-41 (Glass) 1 Watt Device

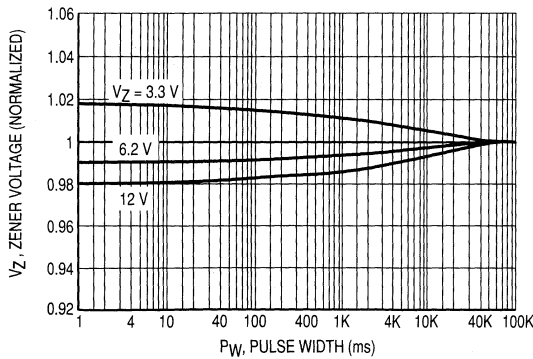

Figure 3. DO-41 (Plastic) 1.5 Watt Device

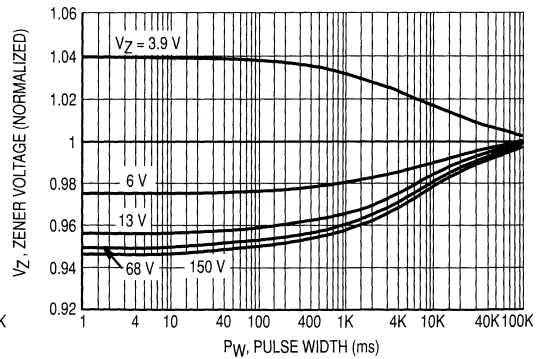

Figure 4. Case 17 (Plastic) 5 Watt Device

7

THREE MOUNTING METHODS: DO-35 AND DO-41

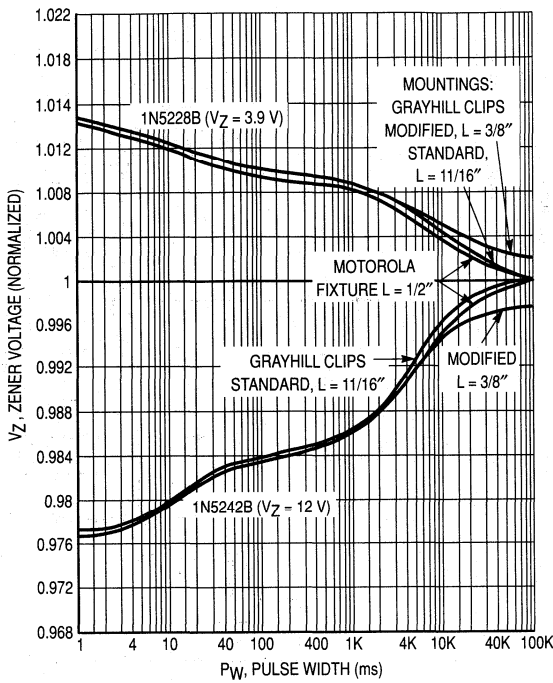

Figure 5. DO-35 (Glass) 500 mW Device

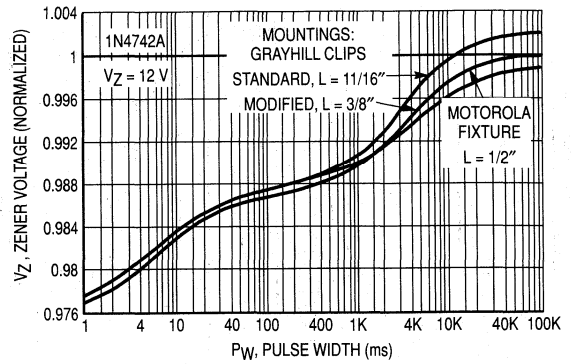

Figure 6. DO-41 (Glass) 1 Watt Device

MOUNTING FIXTURE

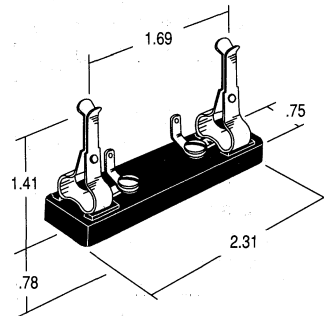

Figure 7. Standard Grayhill Clips

APPENDIX A

Recommended Incoming Inspection Procedures Zener Voltage Testing Pulsed versus Thermal Equilibrium

This section is primarily for use of incoming inspection groups. The subject covered is the measurement of zener voltage (V_Z) and the inherent difficulty of establishing correlation between supplier and buyer when using pulsed test techniques. This difficulty, in part, is due to the interpretation of the data taken from the variety of available testers and in some cases even from the same model types. It is therefore, our intent to define and reestablish a standardized method of measurement to achieve correlation no matter what test techniques are being used. This standardization will guarantee your acceptance of good product while maintaining reliable correlation.

DEFINITION OF TERMS

Temperature Coefficient (TC):

The temperature stability of zener voltages is sometimes expressed by means of the temperature coefficient (TC). This parameter is usually defined as the percent voltage change across the device per degree centigrade, or as a specific voltage change per degree centigrade. Temperature changes during test are due to the self heating effects caused by the dissipation of power in the zener junction. The V_Z will change due to this temperature change and will exhibit a positive or negative TC, depending on the zener voltage. Generally, devices with a zener voltage below five volts will have a negative TC and devices above five volts will exhibit a positive TC.

Thermal Equilibrium (TE)

Thermal equilibrium (TE) is reached when the diode junction temperature has stabilized and no further change will occur. In thermal equilibrium, the heat generated at the junction is removed as rapidly as it is created, hence, no further temperature changes.

MEASURING ZENER VOLTAGE

The zener voltage, being a temperature dependent parameter, needs to be controlled for valid V_Z correlation. Therefore, so that a common base of comparison can be established, a reliable measure of V_Z can only occur when all possible variables are held constant. This common base is achieved when the device under test has had sufficient time to reach thermal equilibrium (heatsinking is required to stabilize the lead or case

temperature to a specified value for stable junction temperatures). The device should also be powered from a constant current source to limit changes of power dissipated and impedance.

All of the above leads us to an understanding of why various pulse testers will give differing V_Z readings; these differences are, in part, due to the time duration of test (pulse width), duty cycle when data logging, contact resistance, tolerance, temperature, etc. To resolve all of this, one only needs a reference standard to compare their pulsed results against and then adjust their limits to reflect those differences. It should be noted that in a large percentage of applications the zener diode is used in thermal equilibrium.

Motorola guarantees all of its axial leaded zener products (unless otherwise specified) to be within specification ninety (90) seconds after the application of power while holding the lead temperatures at $30 \pm 1^\circ\text{C}$, 3/8 of an inch from the device body, any fixture that will meet that criteria will correlate. 30°C was selected over the normally specified 25°C because of its ease of maintenance (no environmental chambers required) in a normal room ambient. A few degrees variation should have negligible effect in most cases. Hence, a moderate to large heatsink in most room ambients should suffice.

Also, it is advisable to limit extraneous air movements across the device under test as this could change thermal equilibrium enough to affect correlation.

SETTING PULSED TESTER LIMITS

Pulsed test techniques do not allow a sufficient time for zener junctions to reach TE. Hence, the limits need to be set at different values to reflect the V_Z at lower junction temperatures. Since there are many varieties of test systems and possible heatsinks, the way to establish these limits is to actually measure both TE and pulsed V_Z on a serialized sample for correlation.

The following examples show typical delta changes in pulsed versus TE readings. The actual values you use for pulsed conditions will depend on your tester. Note, that there are examples for both positive and negative temperature coefficients. When setting the computer limits for a positive TC device, the largest difference is subtracted from the upper limit and the smallest difference is subtracted from the lower limit. In the negative coefficient example the largest change is added to the lower limit and the smallest change is added to the upper limit.

Motorola Zeners

- Thermal equilibrium specifications:
 V_Z at 10 mA, 9 V minimum, 11 V maximum:
(Positive TC)

TE	Pulsed	Difference
9.53 V	9.45 V	-0.08 V
9.35 V	9.38 V	-0.07 V
9.46 V	9.83 V	-0.08 V
9.56 V	9.49 V	-0.07 V
9.50 V	9.40 V	-0.10 V

Computer test limits:

Set V_Z max. limit at $11 \text{ V} - 0.10 \text{ V} = 10.9 \text{ V}$

Set V_Z min. limit at $9 \text{ V} - 0.07 \text{ V} = 8.93 \text{ V}$

- Thermal equilibrium specifications:
 V_Z at 10 mA, 2.7 V minimum, 3.3 V maximum:
(Negative TC)

TE	Pulsed	Difference
2.78 V	2.83 V	+0.05 V
2.84 V	2.91 V	+0.07 V
2.78 V	2.84 V	+0.05 V
2.86 V	2.93 V	+0.07 V
2.82 V	2.87 V	+0.05 V

Computer test limits:

Set V_Z min. limit at $2.7 \text{ V} + 0.07 \text{ V} = 2.77 \text{ V}$

Set V_Z max. limit at $3.3 \text{ V} + 0.05 \text{ V} = 3.35 \text{ V}$

DESIGN CONSIDERATIONS AND PERFORMANCE OF MOTOROLA TEMPERATURE-COMPENSTATED ZENER (REFERENCE) DIODES

Prepared by
Zener Diode Engineering
and
Ronald N. Racino
Reliability and Quality Assurance

This application note defines Motorola temperature-compensated zener (reference) diodes, explains the device characteristics, describes electrical testing, and discusses the advanced concepts of device reliability and quality assurance. It is a valuable aid to those who contemplate designing circuits requiring the use of these devices.

INTRODUCTION

Zener diodes fall into three general classifications: Regulator diodes, reference diodes and transient voltage suppressors. Regulator diodes are normally employed in power supplies where a nearly constant dc output voltage is required despite relatively large changes in input voltage or load resistance. Such devices are available with a wide range of voltage and power ratings, making them suitable for a wide variety of electronic equipments.

Regulator diodes, however, have one limitation: They are temperature-sensitive. Therefore, in applications in which the output voltage must remain within narrow limits during input-voltage, load-current, and temperature changes, a temperature-compensated regulator diode, called a reference diode, is required.

The reference diode is made possible by taking advantage of the differing thermal characteristics of forward- and reverse-biased silicon p-n junctions. A forward-biased junction has a negative temperature coefficient of approximately 2 mV/°C, while reverse-biased junctions have positive temperature coefficients ranging from about 2 mV/°C at 5.5 V to 6 mV/°C at 10 V. Therefore it is possible, by judicious combination of forward- and reverse-biased junctions, to fabricate a device with a very low overall temperature coefficient (Figure 1).

The principle of temperature compensation is further illustrated in Figure 2, which shows the voltage-current characteristics at two temperature points (25 and 100°C) for both a forward- and a reverse-biased junction. The diagram shows that, at the specified test current (I_{ZT}), the absolute value of voltage change (ΔV) for

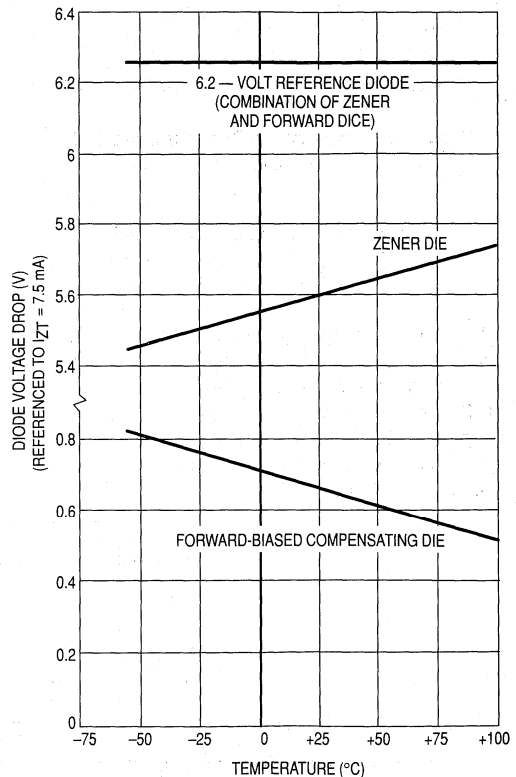

Figure 1. Temperature Compensation of a 6.2 Volt Reference Diode (1N821 Series)

the temperature change between 25 and 100°C is the same for both junctions. Therefore, the total voltage across the combination of these two junctions is also the same at these temperature points, since one ΔV is negative and the other is positive. However, the rate of voltage change with temperature over the temperature range defined by these points is not necessarily the same for both junctions, thus the temperature compensation may not be linear over the entire range.

Figure 2 also indicates that the voltage changes of the two junctions are equal and opposite only at the specified test current. For any other value of current, the temperature compensation may not be complete.

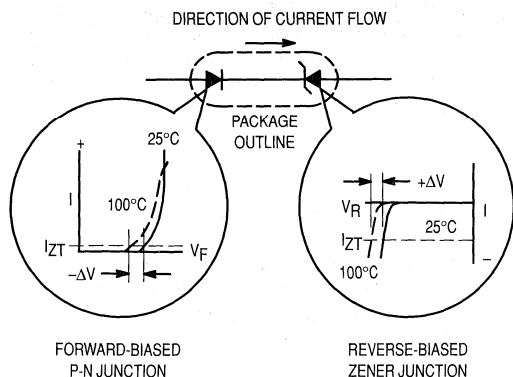

Figure 2. Temperature Compensation of P-N Junctions

IMPORTANT ELECTRICAL CHARACTERISTICS OF REFERENCE DIODES

The three most important characteristics of reference diodes are 1) reference voltage, 2) voltage-temperature stability, and 3) voltage-time stability.

1. Reference Voltage. This characteristic is defined as the voltage drop measured across the diode when the specified test current passes through it in the zener direction. It is also called the zener voltage (V_Z , Figure

3). On the data sheets, the reference voltage is given as a nominal voltage for each family of reference diodes.

The nominal voltages are normally specified to a tolerance of $\pm 5\%$, but devices with tighter tolerances, such as $\pm 2\%$ and $\pm 1\%$, are available on special order.

2. Voltage-Temperature Stability. The temperature stability of zener voltage is sometimes expressed by means of the temperature coefficient. This parameter is usually defined as the percent voltage change across the device per degree centigrade. This method of indicating voltage stability accurately reflects the voltage deviation at the test temperature extremes but not necessarily at other points within the specified temperature range. This fact is due to variations in the rate of voltage change with temperature for the forward- and reverse-biased dice of the reference diode. Therefore, the temperature coefficient is given in Motorola data sheets only as a quick reference, for designers who are accustomed to this method of specification.

A more meaningful way of defining temperature stability is the "box method." This method, used by Motorola, guarantees that the zener voltage will not vary by more than a specified amount over a specified temperature range at the indicated test current, as verified by tests at several temperatures within this range.

Some devices are accurately compensated over a wide temperature range (-55°C to 100°C), others over a narrower range (0 to 75°C). The wide-range devices are, as a rule, more expensive. Therefore, it would be economically wasteful for the designer to specify devices with a temperature range much wider than actually required for the specific device application.

During actual production of reference diodes, it is difficult to predict the compensation accuracy. In the interest of maximum economy, it is common practice to test all

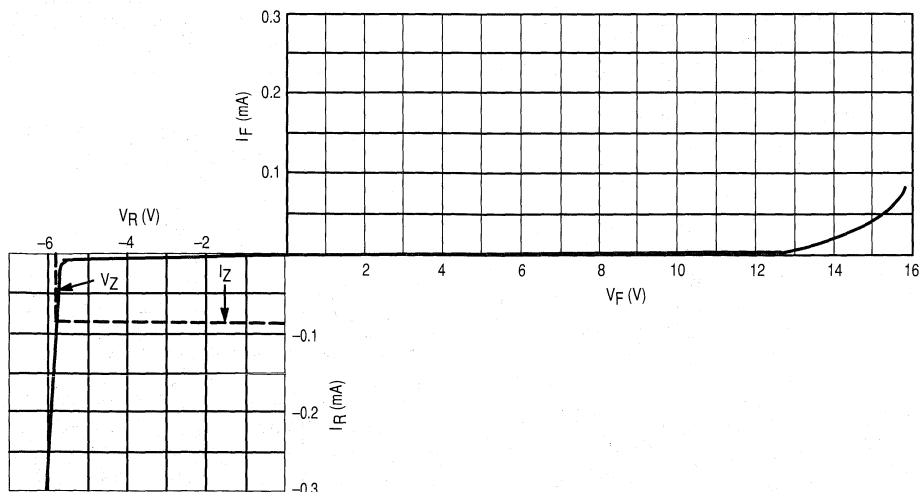

Figure 3. Typical Voltage — Current Characteristic of Reference Diodes

devices coming off the production line, and to divide the production lot into groups, each with a specified maximum ΔV_Z . Each group, then, is given a different device type number.

On the data sheet¹, the voltage-temperature characteristics of the most widely used device types are illustrated in a graph similar to the one shown in Figure 4. The particular production line represented in this figure produces 6.2 volt devices, but the line yields five different device type numbers (1N821 through 1N829), each with a different temperature coefficient. The 1N829, for example, has a maximum voltage change of less than 5 mV over a temperature range of -55 to $+100^\circ\text{C}$, while the 1N821 may have a voltage change of up to 96 mV over the same temperature range.

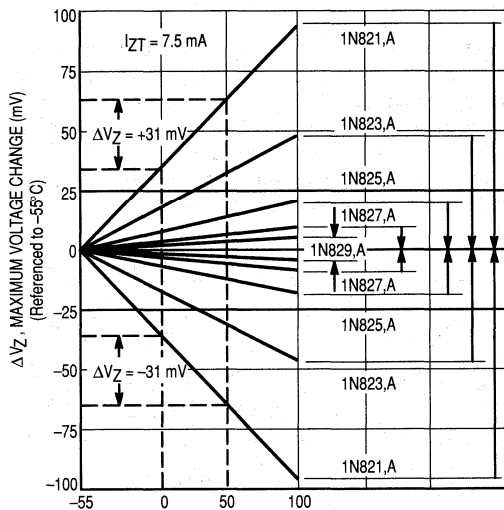

Figure 4. Temperature Dependence of Zener Voltage (1N821 Series)

¹In the past, design data and characteristic curves on data sheets for reference diodes have been somewhat limited: The devices have been characterized principally at the recommended operating point. Motorola has introduced a data sheet, providing device data previously not available, and showing limit curves that permit worst-case circuit design without the need for associated tests required in conjunction with the conventional data sheets.

Graphs such as these permit the selection of the lowest-cost device that meets a particular requirement. They also permit the designer to determine the maximum voltage change of a particular reference diode for a relatively small change in temperature. This is done by drawing vertical lines from the desired temperature points at the abscissa of the graph to intersect with each of the positive- and negative-going curves of the particular device of interest. Horizontal lines are then drawn from these intersects to the ordinate of the graph. The difference between the intersections of these horizontal lines with the ordinate yields the maximum voltage change over the temperature increment. For example, for the

1N821, a change in ambient temperature from 0 to 50°C results in a voltage change of no more than about ± 31 mV.

The reason that the device reference voltage may change in either the negative or positive direction is that after assembly, some of the devices within a lot may be overcompensated while others may be undercompensated. In any design, the "worst-case" condition must be considered. Therefore, in the above example, it can be assumed that the maximum voltage change will not exceed 31 mV.

It should be understood, however, that the above calculations give the maximum possible voltage change for the device type, and by no means the actual voltage change for the individual unit.

3. Voltage-Time Stability. The voltage-time stability of a reference diode is defined by the voltage change during operating time at the standard test current (I_{ZT}) and test temperature (T_A). In general, the voltage stability of a reference diode is better than 100 ppm per 1000 hours of operation.

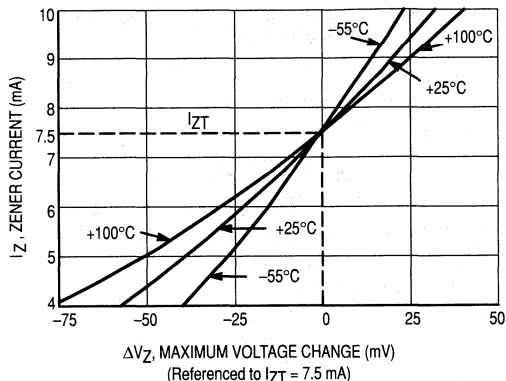

Figure 5. Current Dependence of Zener Voltage at Various Temperatures (1N821 Series)

THE EFFECT OF CURRENT VARIATION ON ZENER VOLTAGE

The nominal zener voltage of a reference diode is specified at a particular value of current, called the zener test current (I_{ZT}). All measurements of voltage change with temperature are referenced to this test current. If the operating current is varied, all these specifications will change.

The effect of current variation on zener voltage, at various temperatures, is graphically illustrated on the 1N821 data sheet as "Zener Current versus Maximum Voltage Change." A typical example of such a graph is shown for the 1N821 series in Figure 5. The voltage change shown is due entirely to the impedance of the device at the fixed temperature. It does not reflect the change in reference voltage due to the change in tem-

perature since each curve is referenced to $I_{ZT} = 7.5$ mA at the indicated temperature. As shown, the greatest voltage change occurs at the highest temperature represented in the diagram. (See "Dynamic Impedance" under the next section).

Figure 5 shows that, at 25°C, a change in zener current from 4 to 10 mA causes a voltage shift of about 90 mV. Comparing this value with the voltage-change example in Figure 4 (31 mV), it is apparent that, in general, a greater voltage variation may be due to current fluctuations than to temperature change. Therefore, good current regulation of the source should be a major consideration when using reference diodes in critical applications.

It is not essential, however, that a reference diode be operated at the specified test current. The new voltage-temperature characteristics for a change in current can be obtained by superimposing the data of Figure 5 on that of Figure 4. A new set of characteristics, at a test current of 4 mA, is shown for the 1N823 in Figure 6, together with the original characteristics at 7.5 mA.

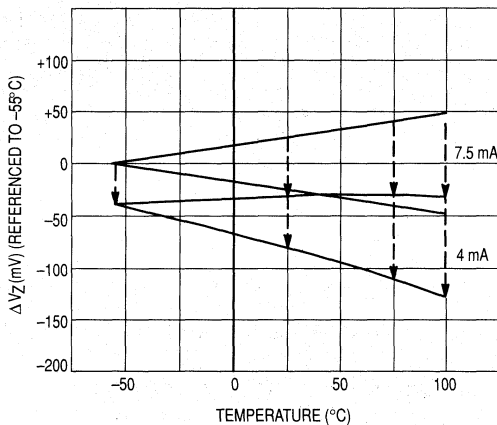

Figure 6. Voltage Change with Temperature for 1N823 at Two Different Current Levels

From these characteristics, it is evident that the voltage change with temperature for the new curves is different from that for the original ones. It is also apparent that if the test current varies between 7.5 and 4 mA, the voltage changes would lie along the dashed lines belonging to the given temperature points. This clearly shows the need for a well-regulated current source.

It should be noted, however, that even when a well-regulated current supply is available, other factors might influence the current flowing through a reference diode. For example, to minimize the effects of temperature-sensitive passive elements in the load circuit on current regulation, it is desirable that the load in parallel with the reference diode have an impedance much higher than the dynamic impedance of the reference diode.

OTHER CHARACTERISTICS

In addition to the three major characteristics discussed earlier, the following parameters and ratings of reference diodes may be considered in some applications.

Power Dissipation

The maximum dc power dissipation indicates the power level which, if exceeded, may result in the destruction of the device. Normally a device will be operated near the specified test current for which the data-sheet specifications are applicable. This test current is usually much below the current level associated with the maximum power dissipation.

Dynamic Impedance

Zener impedance may be construed as composed of a current-dependent resistance shunted by a voltage-dependent capacitance. Figure 7 indicates the typical variations of dynamic zener impedance (Z_Z) with current and temperature for the 1N821 reference diode series. These diagrams are given in the 1N821 data sheet. As shown, the zener impedance decreases with current but increases with ambient temperature.

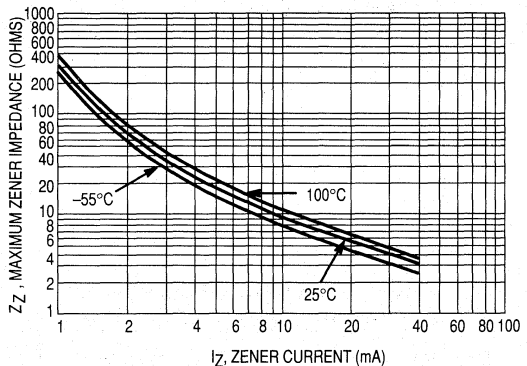

Figure 7. Variation of Zener Impedance With Current and Temperature (1N821 Series)

The impedance of a reference diode is normally specified at the test current (I_{ZT}). It is determined by measuring the ac voltage drop across the device when a 60 Hz ac current with an rms value equal to 10% of the dc zener current is superimposed on the zener current (I_{ZT}). Figure 8 shows the block diagram of a circuit used for testing zener impedance.

ELECTRICAL TESTING

All devices are tested electrically as a last step in the manufacturing process.

The subsequent final test procedures represent an automated and accurate method of electrically classifying reference diodes. First, an electrical test is per-

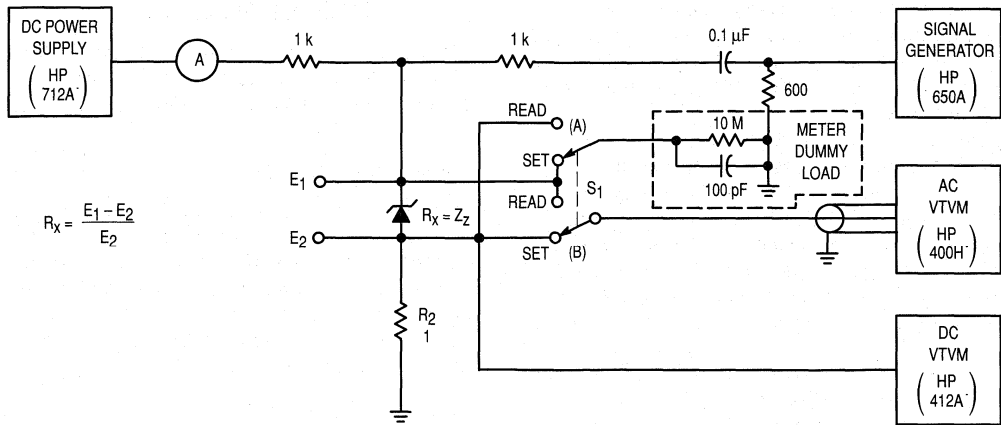

Figure 8. Block Diagram of Test Circuit for Measuring Dynamic Zener Impedance

formed on all devices to insure the correct voltage-breakdown and stability characteristics. Next, the breakdown voltage and dynamic impedance are measured. Finally, the devices are placed in an automatic data acquisition system that automatically cycles them through the complete temperature range specified. The actual voltage measurements at the various temperature points are retained in the system computer memory until completion of the full temperature excursion. The computer then calculates the changes in voltage for each device at each test temperature and classifies all units on test into the proper category. The system provides a printed readout for every device, including the voltage changes to five digits during temperature cycling, and the corresponding EIA type number, as well as the data referring to test conditions such as device position, lot number, and date.

DEVICE RELIABILITY AND QUALITY ASSURANCE

Insuring a very low failure rate requires maximum performance in all areas effecting device reliability: Device design, manufacturing processes, quality control, and reliability testing. Motorola's basic reliability concept is based on the belief that reference diode reliability is a complex yet controllable function of all these variables.

Under this "total reliability" concept, Motorola can mass-produce high-reliability reference diodes.

The reliability of a reference diode fundamentally depends upon the device design, regardless of the degree of effort put into device screening and circuit designing. Therefore, reliability measures must be incorporated at the device design and process development stages to establish a firm foundation for a comprehensive reliability program. The design is then evaluated by thorough reliability testing, and the results are supplied to the

Design Engineering department. This closed-loop feedback procedure provides valuable information necessary to improve important design features such as electrical instability due to surface effects, mechanical strength, and uniformly low thermal resistance between the die and ambient environment.

Process Control

There are more than 2000 variables that must be kept under control to fabricate a reliable reference diode. The in-process quality control group controls most of these variables. It places a strict controls on all aspects of manufacturing from materials procurement to the finished product. Included in this broad spectrum of controls are:

- **Materials Control.** All materials purchased or fabricated in-plant are checked against rigid specifications. A quality check on vendors' products is kept up to date to insure that only materials of a proven quality level will be purchased.

- **In-Process Inspection and Control.** Numerous on-line inspection stations maintain a statistical process control program on specific manufacturing processes. If any of these processes are found to be out of control, the discrepant material is diverted from the normal production flow and the cognizant design engineer notified. Corrective action is initiated to remedy the cause of the discrepancy.

Reliability Testing

The Reliability Engineering group evaluates all new products and gives final conclusions and recommendations to the device design engineer. The Reliability Engineering group also performs independent testing of all products and includes, as part of this testing program, step-stress-to-failure testing to determine the maximum capabilities of the product.

1

**Index of
Part Numbers**

2

**Cross Reference
Guide**

3

**Preferred
Part Numbers Guide**

4

**Selector Guides
and Data Sheets**

5

**Packaging
Information**

6

**Technical
Information**

7

**Application Notes
and Articles**





MOTOROLA

Literature Distribution Centers:

USA: Motorola Literature Distribution; P.O. Box 20912; Phoenix, Arizona 85036.

EUROPE: Motorola Ltd.; European Literature Center; 88 Tanners Drive, Blakelands, Milton Keynes, MK14 5BP, England.

JAPAN: Nippon Motorola Ltd.; 4-32-1, Nishi-Gotanda, Shinagawa-ku, Tokyo 141 Japan.

ASIA-PACIFIC: Motorola Semiconductors H.K. Ltd.; Silicon Harbour Center, No. 2 Dai King Street, Tai Po Industrial Estate, Tai Po, N.T., Hong Kong.